

NUMBER C-179609



METRIC

DIMENSIONS IN MILLIMETERS. DO NOT SCALE PRINT

PRINT DIST

MATE 0.6 DIA POST
Ø0.6ポストと嵌合

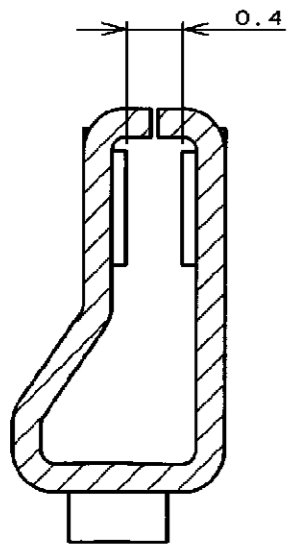
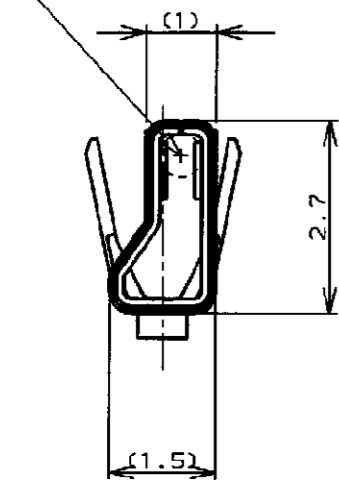

SECT "C" - "C"
(SCALE 20-1)

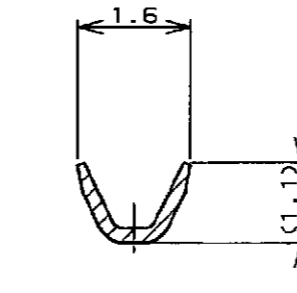
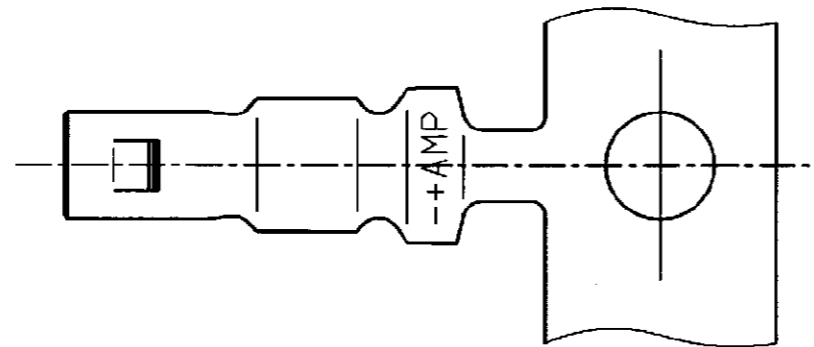
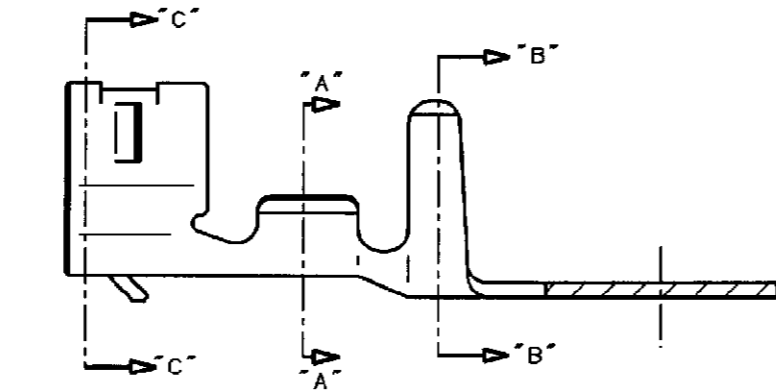
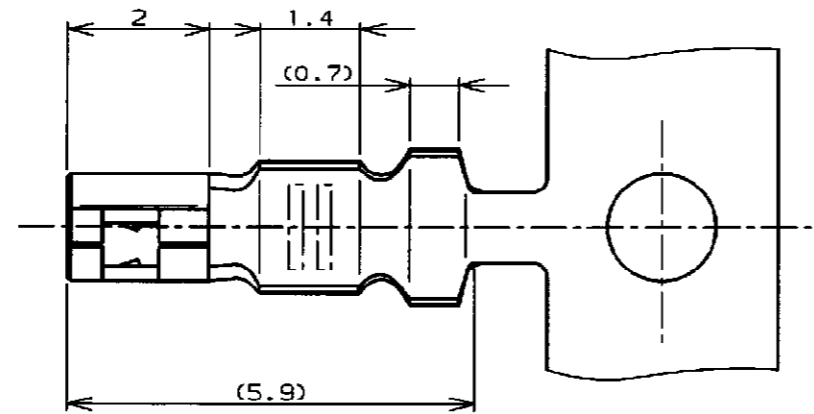

SECT "A" - "A"

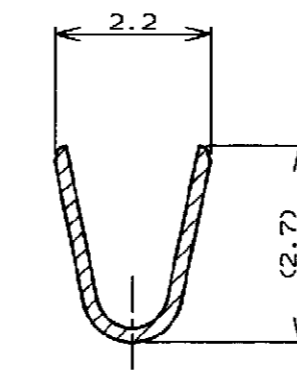

SECT "B" - "B"

注:

1. 使用ハウジングは型番 179228
2. 製品規格 : 108-5408
3. 取付適用規格 : 114-5179

NOTES,

1. USE HOUSING ; P/N 179228
2. PRODUCT SPEC ; 108-5408
3. APPLICATION SPEC ; 114-5179

PRE TINNED COPPER ALLOY (0.2t) 銅の合金めっき銅 (板厚0.2)	179609-1
MATERIAL & FINISH 材質	PART NO. 型番



WIRE RANGE 0.05 ~0.12 mm ² (AWG30-26)	INSULATION DIA 0.65-1.35 mmφ	NAME 圧着タイプIIリセコンタクト CRIMP TYPE II RECEPTACLE CONTACT (AMP CT CONNECTOR 2mm PITCH)		
MATERIAL SEE TABLE 表参照	FINISH SEE TABLE 表参照	GENERAL TOLERANCE	SIZE LOC NUMBER	
DR. T. FURUYA 1/23 '96	DE. T. FURUYA 1/23 '96	0<≦10 : ±0.2 10<≦30 : ±0.25 30<≦100 : ±0.3 ANGLES : ±3°	B J	C-179609
CHK. S. KUBOUCHI 1/23 '96	APP. S. Kubouchi 1/23 '96	SCALE 10-1	REV. B3	SHEET 1 OF 1

B3	REVISED PER ECR-15-004801	RK	HMR	SAPR11
LTR	REVISION RECORD	DR	CHK	DATE