

## User's Guide

# D120MY-20-2002

# **VFD- RoHS Compliant**

(Vacuum Fluorescent Display Module)

---

For product support, contact

**Newhaven Display International**  
**2511 Technology Drive, #101**  
**Elgin, IL 60124**

Tel: (847) 844-8795 Fax: (847) 844-8796

February 26, 2008

# Vacuum Fluorescent Display Specification

**PART NUMBER:** D0120MY-20-2002

**FEATURES:** 20 Digits, Alphanumeric

**APPLICATION:** Character Display (*Alphanumeric*)

**RATINGS:** Below

<b>Outer Dimensions</b>	Panel Length	P.L.	134.0	mm	
	Panel Height	P.H.	20.5	mm	
	Panel Thickness	P.T.	6.5	mm	
<b>Leads</b>	Lead Pitch	L.P.	2.54	mm	
	Lead Out	-	SIL		
<b>Character Size</b>	Character Height	C.H.	6.5	mm	
	Character Width	C.W.	3.0	mm	
<b>Item</b>	<b>Symbol</b>	<b>Min.</b>	<b>Recommended</b>	<b>Max.</b>	<b>Unit</b>
<b>Filament Voltage</b>	Ef	5.22	5.8	6.38	Vac
<b>Peak Grid Voltage</b>	ec	-	32.0	39.0	Vp-p
<b>Peak Anode Voltage</b>	eb	-	32.0	39.0	Vp-p
<b>Cut-off Bias</b>	Ek	-	-	-	-
<b>Duty Cycle</b>	Du	-	1/ 24	-	-
<b>Pulse Width</b>	tp	-	100	-	uS
<b>Operating Temperature</b>	Topr	-20	-	+ 70	C
<b>Storage Temperature</b>	Tstg	-55	-	+ 80	C
<b>Color of Illumination</b>	Green				

**Electrical  
Characteristics**

Item	Symbol	Test Condition	Min.	Typical	Max.	Unit
<b>Filament Current</b>	If	Ef = 5.8 Vac	54.0	60.0	66.0	mAac
	-	eb = ec = 0	-	-	-	-
<b>Anode Current</b>	ib/1~20G	Ef = 5.6 Vac	-	3.5	7.0	mAp-p
	-	eb = 30.0 Vp-p	-	-	-	mAp-p
	-	ec = 30.0 Vp-p	-	-	-	mAp-p
	-	Du = 1/24	-	-	-	mAp-p
	-	tp = 100 uS	-	-	-	mAp-p
<b>Grid Current</b>	ic/1~20G	All Segs are lit	-	3.5	7.0	mAp-p
	-		-	-	-	mAp-p
	-		-	-	-	mAp-p
	-		-	-	-	mAp-p
	-		-	-	-	mAp-p
<b>Luminance</b>	L(G)		514	1028	-	cd/m <sup>2</sup>
	-		(150)	(300)	-	fL
<b>Luminance Ratio</b>	Lmin/Lmax		50	-	-	%
<b>Grid Cut-off Voltage</b>	Ecco	Ef = 5.8 Vac Eb = 32.0 Vdc	-7.0	-	-	Vdc
<b>Anode Cut-off Voltage</b>	Ebco	Ef = 5.8 Vac ec = 32.0 Vp-p Du = 1/24 tp = 100 uS	-4.0	-	-	Vdc

\* Drive Mode is Dynamic State

Outline Drawing (Unit:mm)

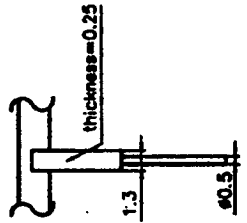
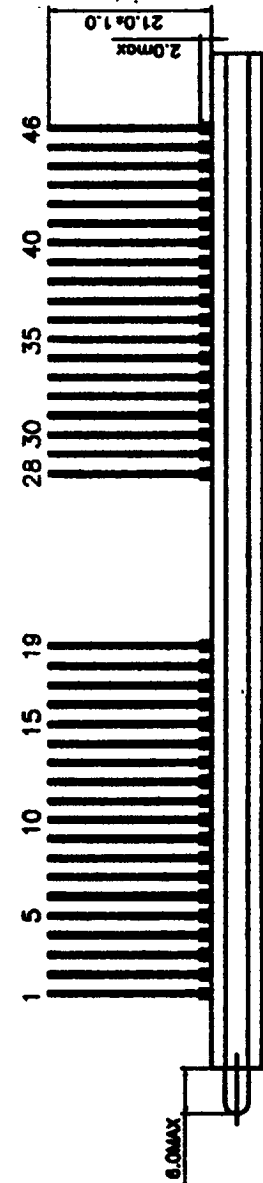
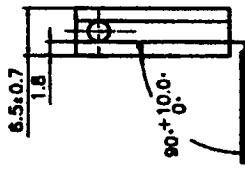
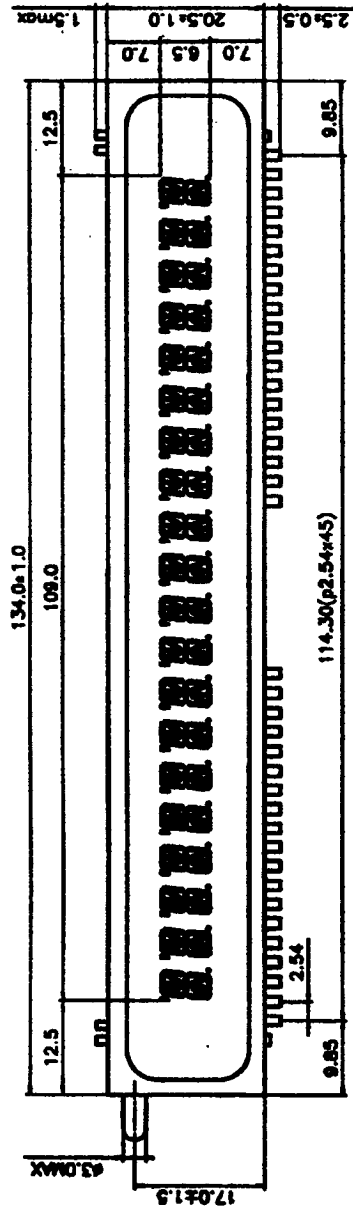

LEAD DETAILS

PIN CONNECTION

端子序号	TERMINAL NO.	1	2	3	4	5	6	7	8	9	10	11	12	13	14	15	16	17	18	19	20	21	22	23
连接	ELECTRODE	F	P1	P2	P3	P4	P5	P6	P7	P8	20G	19G	18G	17G	16G	15G	14G	13G	12G	11G	NP	NP	NP	NP
端子序号	TERMINAL NO.	24	25	26	27	28	29	30	31	32	33	34	35	36	37	38	39	40	41	42	43	44	45	46
连接	ELECTRODE	NP	NP	NP	NP	10G	9G	8G	7G	6G	5G	4G	3G	2G	1G	P9	P10	P11	P12	P13	P14	P15	P16	F

NOTE: F: Filament G: Grid P: Anode NP: No pin

Display Pattern and Grid Assignment

20G

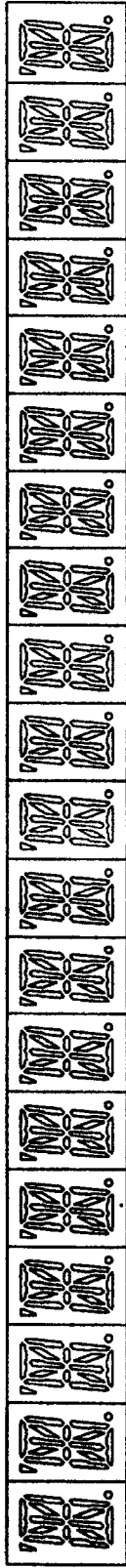

1G

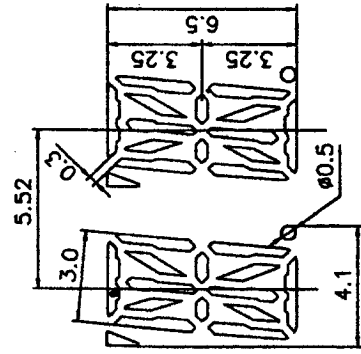
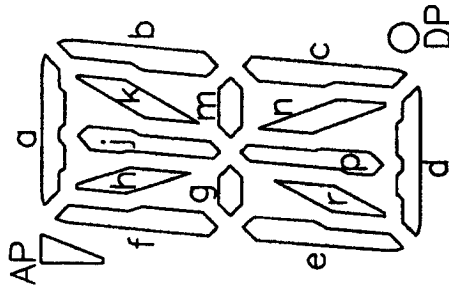

COLOR OF ILLUMINATION

Green (G:x=0.250,y=0.440)

Anode Connection

	1G	2G	3G	4G	5G	6G	7G	8G	9G	10G	11G	12G	13G	14G	15G	16G	17G	18G	19G	20G	
P1	f	f	f	f	f	f	f	f	f	f	f	f	f	f	f	f	f	f	f	f	f
P2	g	g	g	g	g	g	g	g	g	g	g	g	g	g	g	g	g	g	g	g	g
P3	e	e	e	e	e	e	e	e	e	e	e	e	e	e	e	e	e	e	e	e	e
P4	r	r	r	r	r	r	r	r	r	r	r	r	r	r	r	r	r	r	r	r	r
P5	n	n	n	n	n	n	n	n	n	n	n	n	n	n	n	n	n	n	n	n	n
P6	p	p	p	p	p	p	p	p	p	p	p	p	p	p	p	p	p	p	p	p	p
P7	DP	DP	DP	DP	DP	DP	DP	DP	DP	DP	DP	DP	DP	DP	DP	DP	DP	DP	DP	DP	DP
P8	d	d	d	d	d	d	d	d	d	d	d	d	d	d	d	d	d	d	d	d	d
P9	c	c	c	c	c	c	c	c	c	c	c	c	c	c	c	c	c	c	c	c	c
P10	m	m	m	m	m	m	m	m	m	m	m	m	m	m	m	m	m	m	m	m	m
P11	b	b	b	b	b	b	b	b	b	b	b	b	b	b	b	b	b	b	b	b	b
P12	h	h	h	h	h	h	h	h	h	h	h	h	h	h	h	h	h	h	h	h	h
P13	k	k	k	k	k	k	k	k	k	k	k	k	k	k	k	k	k	k	k	k	k
P14	j	j	j	j	j	j	j	j	j	j	j	j	j	j	j	j	j	j	j	j	j
P15	AP	AP	AP	AP	AP	AP	AP	AP	AP	AP	AP	AP	AP	AP	AP	AP	AP	AP	AP	AP	AP
P16	a	a	a	a	a	a	a	a	a	a	a	a	a	a	a	a	a	a	a	a	a