

THIS DRAWING IS UNPUBLISHED. RELEASED FOR PUBLICATION

© COPYRIGHT - By - ALL RIGHTS RESERVED.

LOC	DIST	REVISIONS			
P	LTR	DESCRIPTION	DATE	DWN	APVD
AF	50	J	REVISE PER ECR-13-003819	06AUG13	GRZ DZ

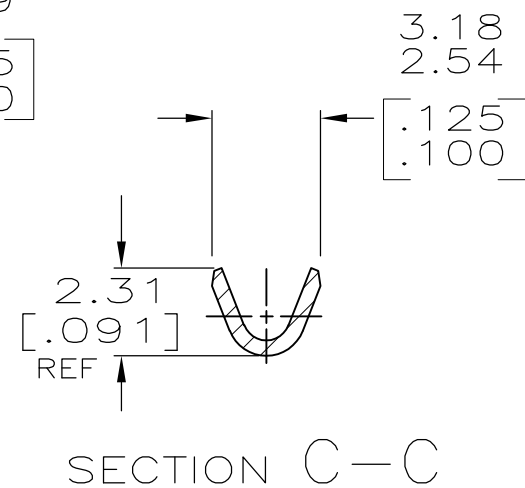
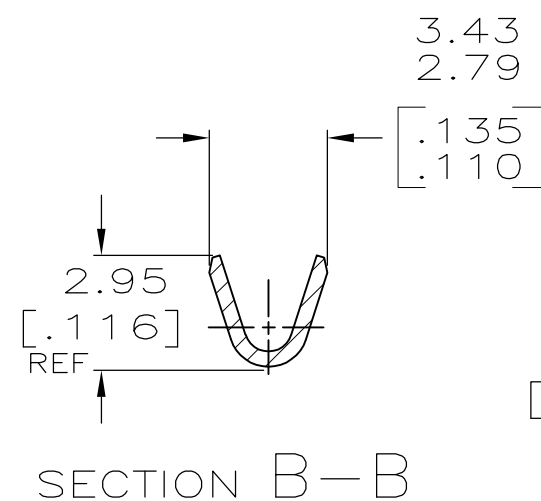
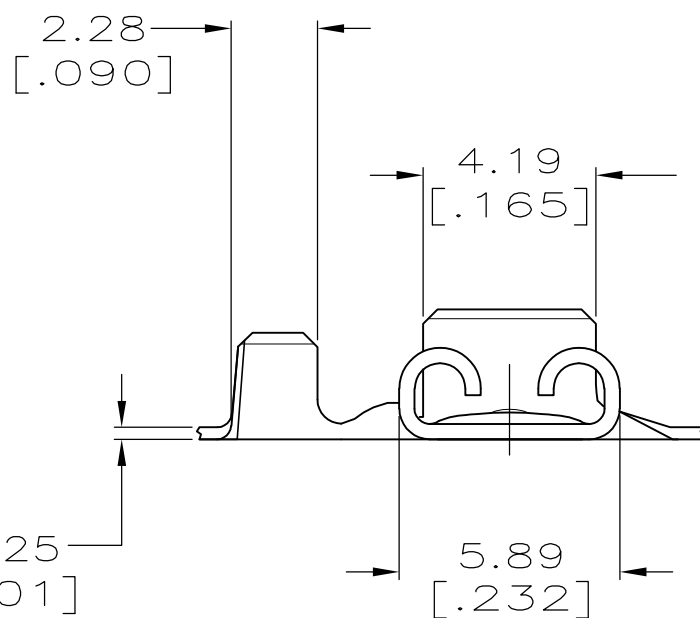
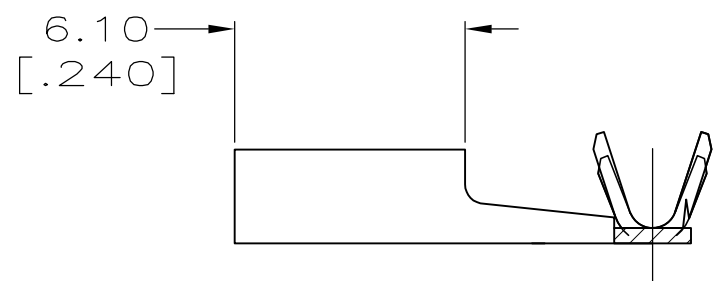
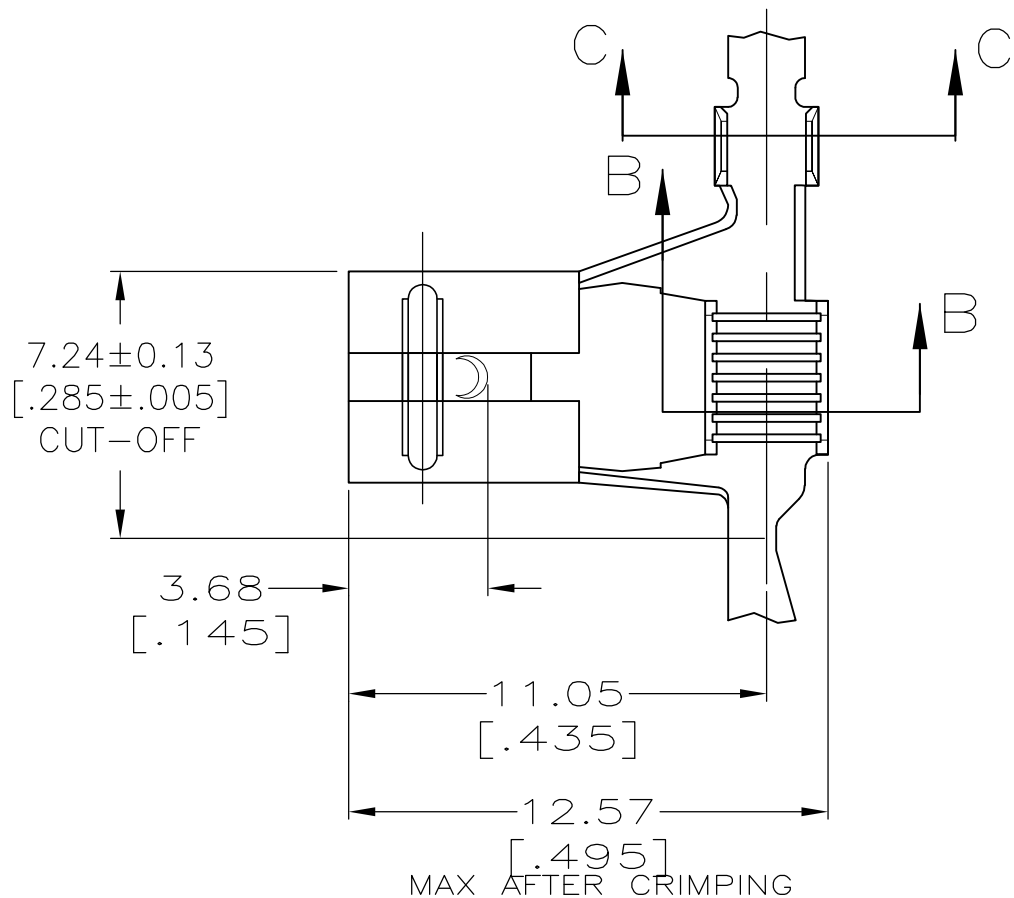

- 1 CONTINUOUS STRIP ON REELS.
- 2 ACCEPTS MAGNET WIRE RANGES 1200-2350 CMA.
- 3 MATING TAB THK TO BE 0.51±0.025 [.020±.001].

63941-1  
PART NO.

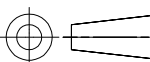
THIS DRAWING IS A CONTROLLED DOCUMENT.		DWN	JR RUTH	9/30/96	 <b>TE Connectivity</b>			NAME RECEPTACLE, FASTON, FLAG, AMPLIVAR, 4.75 [.187] SERIES						
DIMENSIONS: mm		CHK	MS FEHER	9/30/96										
		APVD	P DESANTIS	9/30/96										
TOLERANCES UNLESS OTHERWISE SPECIFIED: 0 PLC ± - 1 PLC ± - 2 PLC ± 0.25 [.010] 3 PLC ± - 4 PLC ± - ANGLES ± -		PRODUCT SPEC	-											
MATERIAL	BRASS	FINISH	TIN PLATE	APPLICATION SPEC	-		SIZE	A3	CAGE CODE	00779	DRAWING NO	C-63941	RESTRICTED TO	-
CUSTOMER DRAWING				WEIGHT	-		SCALE	5:1	SHEET	1 OF 1	REV	J		