

High Voltage IGBT w/ Sonic Diode

IXGT16N170A
IXGH16N170A
IXGT16N170AH1
IXGH16N170AH1

$V_{CES} = 1700V$
 $I_{C90} = 11A$
 $V_{CE(sat)} \leq 5.0V$
 $t_{fi(typ)} = 35ns$

Symbol	Test Conditions	Maximum Ratings	
V_{CES}	$T_J = 25^\circ C$ to $150^\circ C$	1700	V
V_{CGR}	$T_J = 25^\circ C$ to $150^\circ C$, $R_{GE} = 1M\Omega$	1700	V
V_{GES}	Continuous	± 20	V
V_{GEM}	Transient	± 30	V
I_{C25}	$T_C = 25^\circ C$	16	A
I_{C90}	$T_C = 90^\circ C$	11	A
I_{F90}	$T_C = 90^\circ C$	17	A
I_{CM}	$T_C = 25^\circ C$, 1ms	40	A
SSOA	$V_{GE} = 15V$, $T_{VJ} = 125^\circ C$, $R_G = 10\Omega$	$I_{CM} = 40$	A
(RBSOA)	Clamped Inductive Load	$0.8 \cdot V_{CES}$	
t_{sc}	$V_{GE} = 15V$, $V_{CE} = 1200V$, $T_J = 125^\circ C$	10	μs
(SCSOA)	$R_G = 22\Omega$, Non Repetitive		
P_C	$T_C = 25^\circ C$	190	W
T_J		-55 ... +150	$^\circ C$
T_{JM}		150	$^\circ C$
T_{stg}		-55 ... +150	$^\circ C$
T_L	Maximum Lead Temperature for Soldering	300	$^\circ C$
T_{SOLD}	Plastic Body for 10s	260	$^\circ C$
M_d	Mounting Torque (TO-247)	1.13/10	Nm/lb.in
Weight	TO-268	4	g
	TO-247	6	g

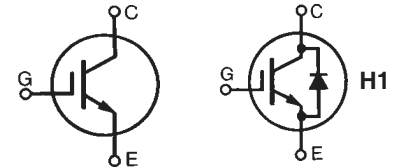

TO-268 (IXGT)

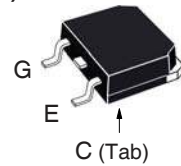

TO-247 (IXGH)

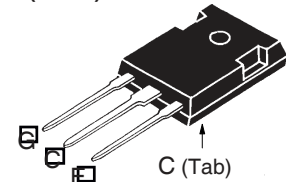

G = Gate C = Collector
E = Emitter Tab = Collector

Features

- High Blocking Voltage
- International Standard Packages
- Low Conduction Losses
- Anti-Parallel Sonic Diode
- High Blocking Voltage
- High Current Handling Capability

Advantages

- Low Gate Drive Requirement
- High Power Density

Applications

- Switch-Mode and Resonant-Mode Power Supplies
- Uninterruptible Power Supplies (UPS)
- AC Choppers
- Capacitor Discharge Circuits
- AC Motor Drives
- DC Servo & Robot Drives

Symbol	Test Conditions	Characteristic Values		
		Min.	Typ.	Max.
BV_{CES}	$I_C = 250\mu A$, $V_{GE} = 0V$	1700		V
$V_{GE(th)}$	$I_C = 250\mu A$, $V_{CE} = V_{GE}$	3.0		5.0 V
I_{CES}	$V_{CE} = 0.8 \cdot V_{CES}$, $V_{GE} = 0V$ $T_J = 125^\circ C$	16N170A		50 μA
		16N170AH1		100 μA
		16N170A		750 μA
		16N170AH1		1.5 mA
I_{GES}	$V_{CE} = 0V$, $V_{GE} = \pm 20V$			± 100 nA
$V_{CE(sat)}$	$I_C = 11A$, $V_{GE} = 15V$, Note 1 $T_J = 125^\circ C$		4.0	5.0 V
			4.5	V

Symbol	Test Conditions	Characteristic Values		
		Min.	Typ.	Max.
g_{fs}	$I_C = 16A, V_{CE} = 10V, \text{Note 1}$	6.0	12.5	S
C_{ies} C_{oes} C_{res}	$V_{CE} = 25V, V_{GE} = 0V, f = 1MHz$	16N170A 16N170AH1	1500	pF
			99	pF
			110	pF
			33	pF
$Q_{g(on)}$ Q_{ge} Q_{gc}	$I_C = 11A, V_{GE} = 15V, V_{CE} = 0.5 \cdot V_{CES}$		70	nC
			9	nC
			32	nC
$t_{d(on)}$ t_{ri} E_{on} $t_{d(off)}$ t_{fi} E_{off}	Inductive load, $T_J = 25^\circ C$ $I_C = 16A, V_{GE} = 15V$ $V_{CE} = 0.5 \cdot V_{CES}, R_G = 10\Omega$ Note 2		12	ns
			22	ns
			2.35	mJ
			200	300 ns
			35	150 ns
			0.38	1.50 mJ
$t_{d(on)}$ t_{ri} E_{on} $t_{d(off)}$ t_{fi} E_{off}	Inductive load, $T_J = 125^\circ C$ $I_C = 16A, V_{GE} = 15V$ $V_{CE} = 0.5 \cdot V_{CES}, R_G = 10\Omega$ Note 2		13	ns
			22	ns
			2.80	mJ
			210	ns
			88	ns
			0.67	mJ
R_{thJC} R_{thCS}			0.65 °C/W 0.21 °C/W	

Reverse Sonic Diode (FRD)

Symbol	Test Conditions	Characteristic Values		
		Min.	Typ.	Max.
V_F	$I_F = 20A, V_{GE} = 0V, \text{Note 1}$	$T_J = 125^\circ C$	2.8	3.4 V
t_{rr} I_{RM}	$I_F = 10A, V_{GE} = 0V,$ $-di_F/dt = 250A/\mu s, V_R = 900V$	$T_J = 125^\circ C$	300	ns
			550	ns
			13	A
		$T_J = 125^\circ C$	15	A
R_{thJC}			1.5 °C/W	

Notes:

1. Pulse test, $t \leq 300\mu s$, duty cycle, $d \leq 2\%$.
2. Switching times & energy losses may increase for higher V_{CE} (clamp), T_J or R_G .

TO-268 Outline

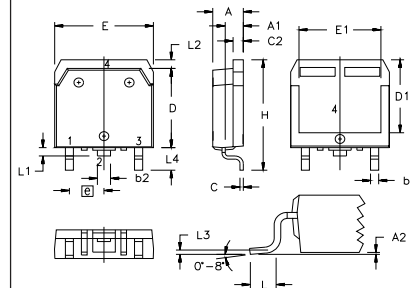

Terminals: 1 - Gate 2,4 - Collector
3 - Emitter

SYM	INCHES		MILLIMETERS	
	MIN	MAX	MIN	MAX
A	.193	.201	4.90	5.10
A1	.106	.114	2.70	2.90
A2	.001	.010	0.02	0.25
b	.045	.057	1.15	1.45
b2	.075	.083	1.90	2.10
C	.016	.026	0.40	0.65
C2	.057	.063	1.45	1.60
D	.543	.551	13.80	14.00
D1	.488	.500	12.40	12.70
E	.624	.632	15.85	16.05
E1	.524	.535	13.30	13.60
e	.215 BSC		5.45 BSC	
H	.736	.752	18.70	19.10
L	.094	.106	2.40	2.70
L1	.047	.055	1.20	1.40
L2	.039	.045	1.00	1.15
L3	.010 BSC		0.25 BSC	
L4	.150	.161	3.80	4.10

TO-247 Outline

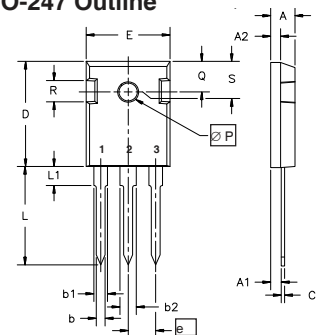

Terminals: 1 - Gate 2 - Collector
3 - Emitter

Dim.	Millimeter		Inches	
	Min.	Max.	Min.	Max.
A	4.7	5.3	.185	.209
A ₁	2.2	2.54	.087	.102
A ₂	2.2	2.6	.059	.098
b	1.0	1.4	.040	.055
b ₁	1.65	2.13	.065	.084
b ₂	2.87	3.12	.113	.123
C	.4	.8	.016	.031
D	20.80	21.46	.819	.845
E	15.75	16.26	.610	.640
e	5.20	5.72	0.205	0.225
L	19.81	20.32	.780	.800
L1		4.50		.177
∅P	3.55	3.65	.140	.144
Q	5.89	6.40	0.232	0.252
R	4.32	5.49	.170	.216
S	6.15	BSC	242	BSC

IXYS Reserves the Right to Change Limits, Test Conditions, and Dimensions.

IXYS MOSFETs and IGBTs are covered by one or more of the following U.S. patents:	4,835,592	4,931,844	5,049,961	5,237,481	6,162,665	6,404,065 B1	6,683,344	6,727,585	7,005,734 B2	7,157,338B2
	4,860,072	5,017,508	5,063,307	5,381,025	6,259,123 B1	6,534,343	6,710,405 B2	6,759,692	7,063,975 B2	
	4,881,106	5,034,796	5,187,117	5,486,715	6,306,728 B1	6,583,505	6,710,463	6,771,478 B2	7,071,537	

Fig. 1. Output Characteristics @ $T_J = 25^\circ\text{C}$

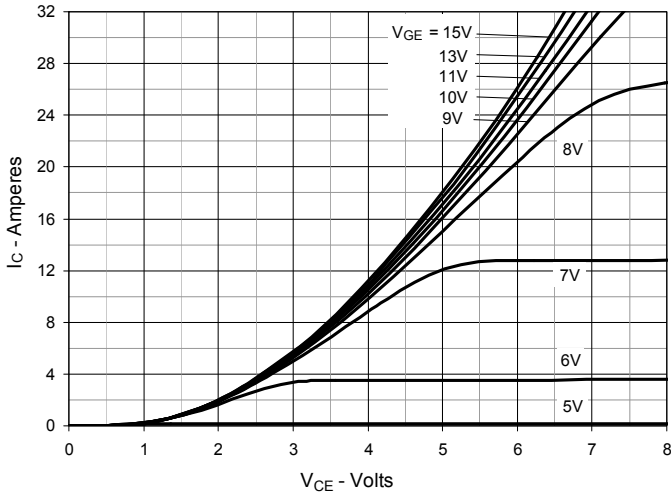

Fig. 2. Extended Output Characteristics @ $T_J = 25^\circ\text{C}$

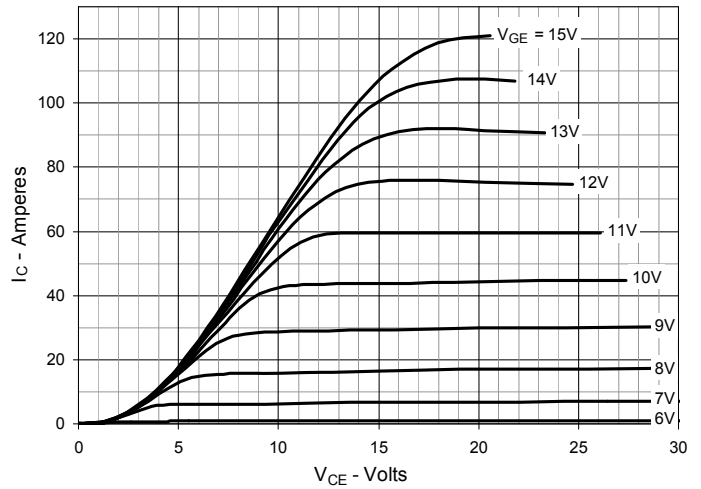

Fig. 3. Output Characteristics @ $T_J = 125^\circ\text{C}$

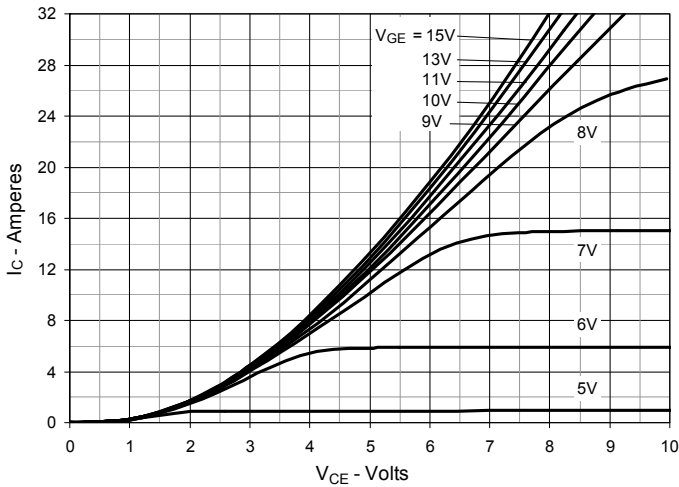

Fig. 4. Dependence of $V_{CE(sat)}$ on Junction Temperature

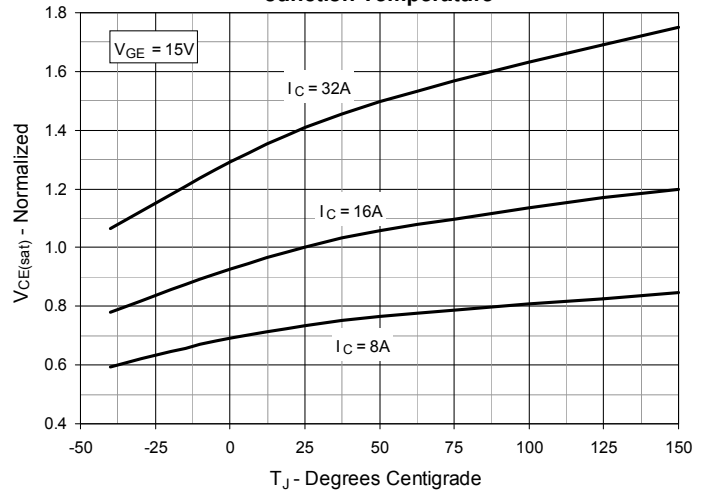

Fig. 5. Collector-to-Emitter Voltage vs. Gate-to-Emitter Voltage

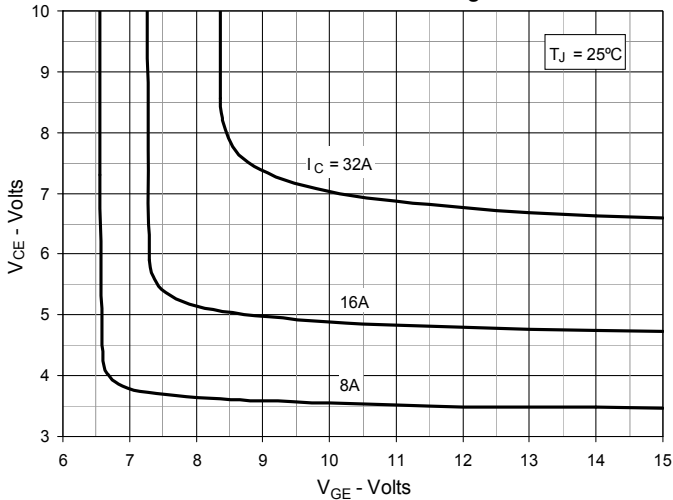

Fig. 6. Input Admittance

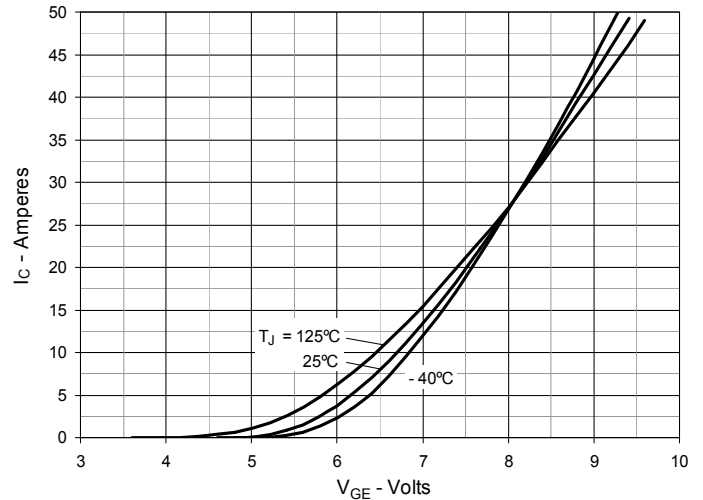

Fig. 7. Transconductance

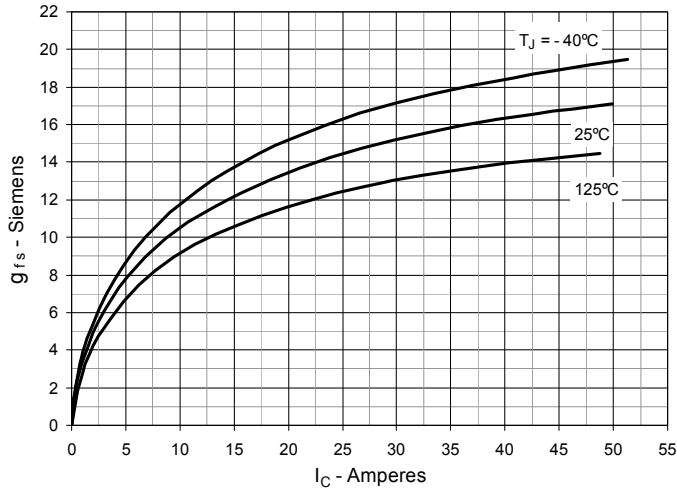

Fig. 8. Gate Charge

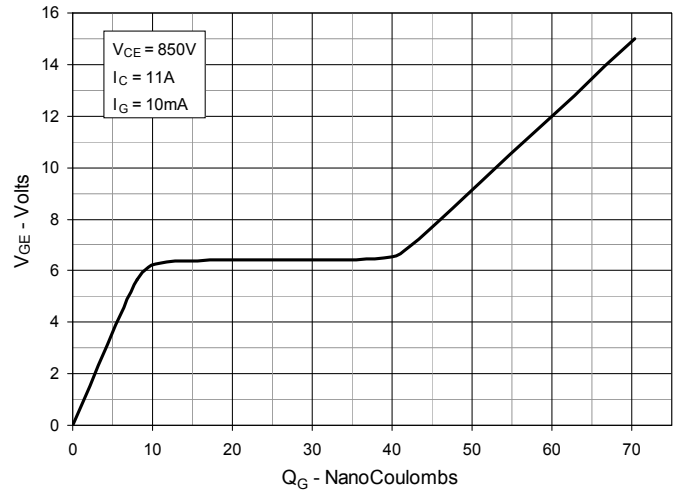

Fig. 9. Capacitance

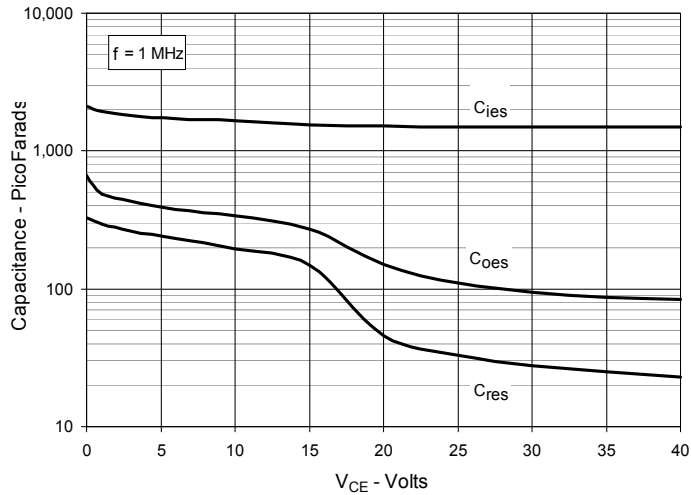

Fig. 10. Reverse-Bias Safe Operating Area

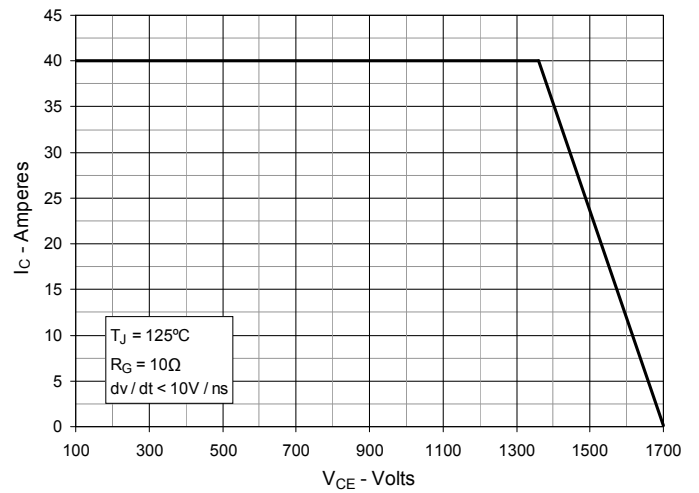

Fig. 11. Maximum Transient Thermal Impedance (IGBT)

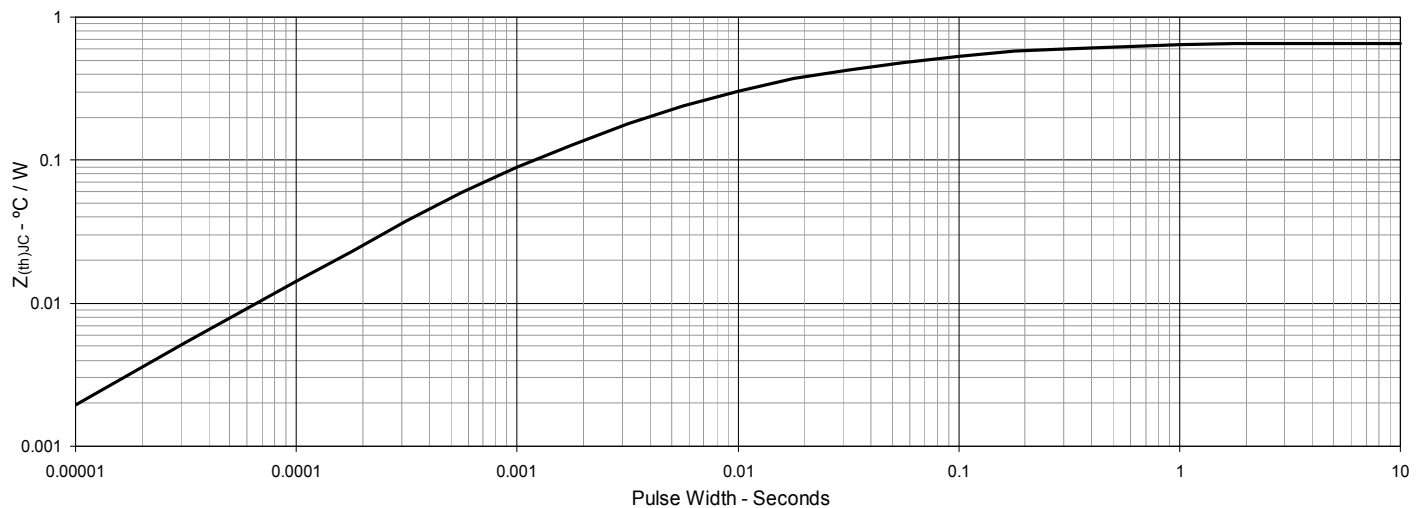

Fig. 12. Inductive Switching Energy Loss vs. Gate Resistance

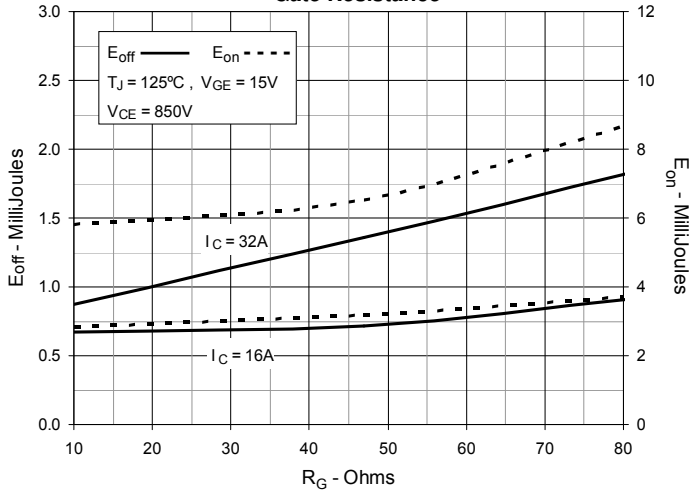

Fig. 13. Inductive Switching Energy Loss vs. Collector Current

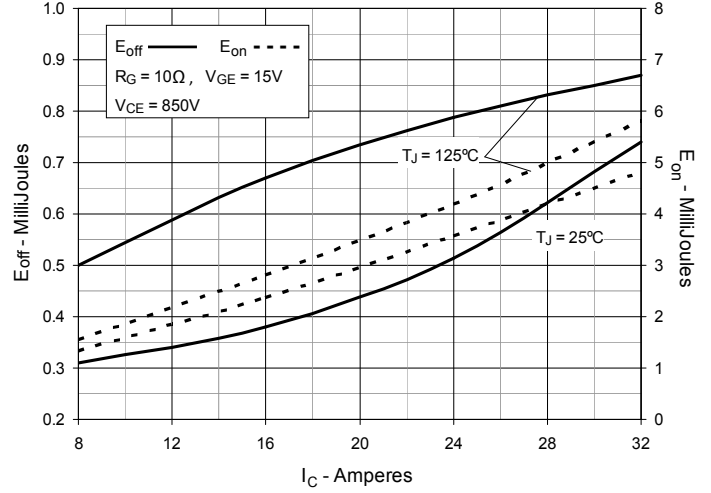

Fig. 14. Inductive Switching Energy Loss vs. Junction Temperature

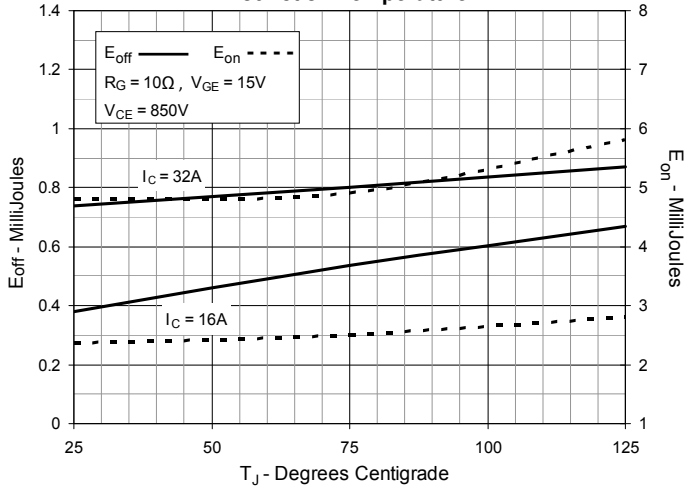

Fig. 15. Inductive Turn-off Switching Times vs. Gate Resistance

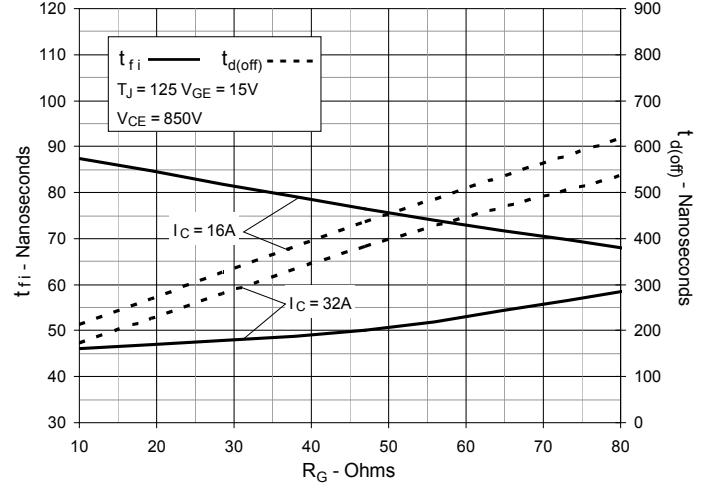

Fig. 16. Inductive Turn-off Switching Times vs. Collector Current

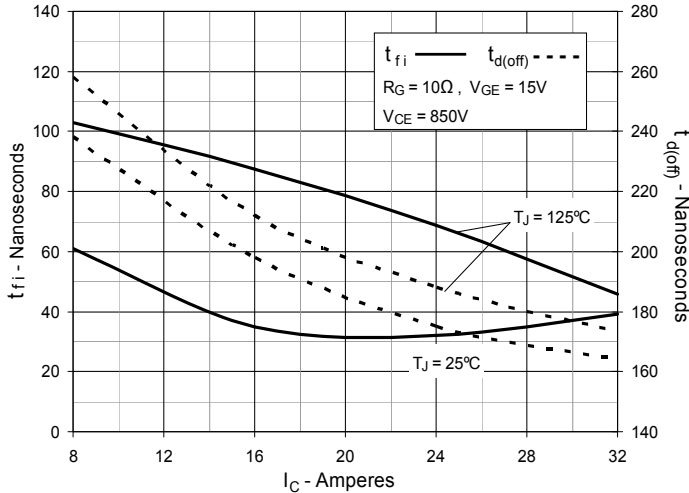

Fig. 17. Inductive Turn-off Switching Times vs. Junction Temperature

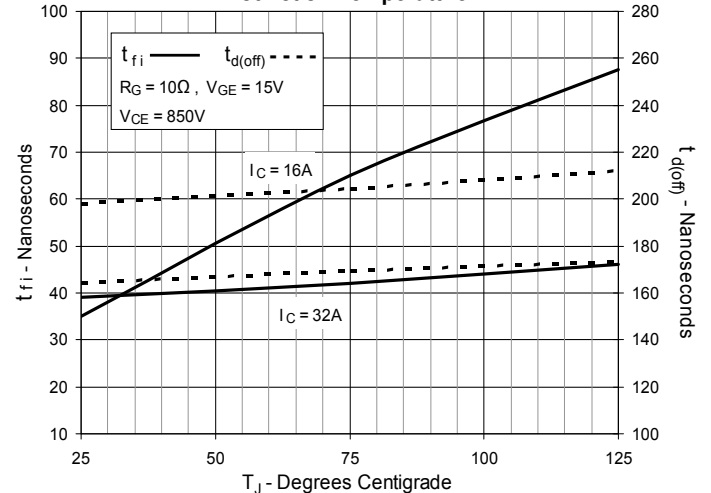

Fig. 18. Inductive Turn-on Switching Times vs. Gate Resistance

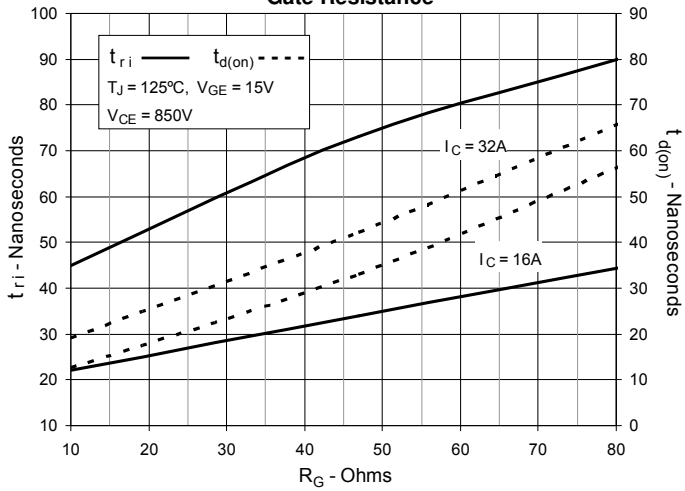

Fig. 19. Inductive Turn-on Switching Times vs. Collector Current

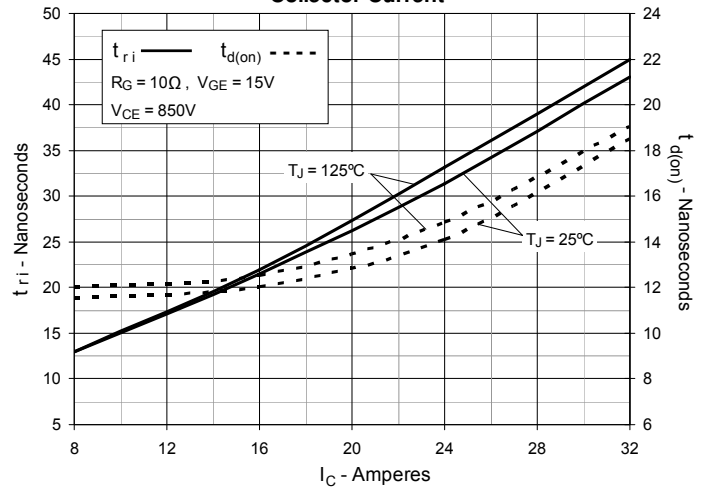

Fig. 20. Inductive Turn-on Switching Times vs. Junction Temperature

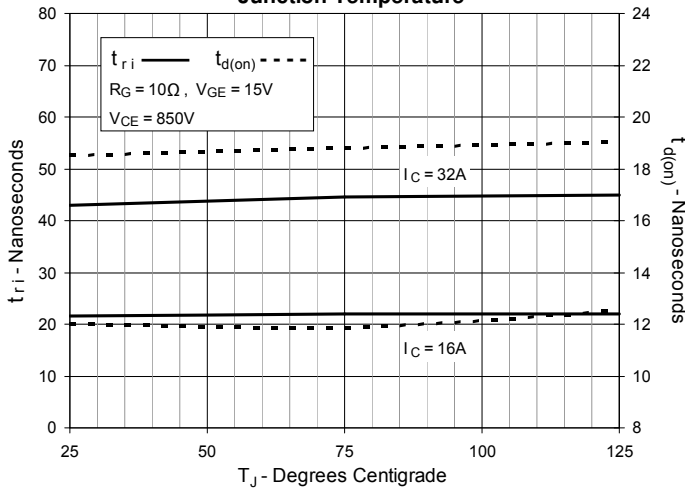

Fig. 21. Forward Current I_F vs V_F

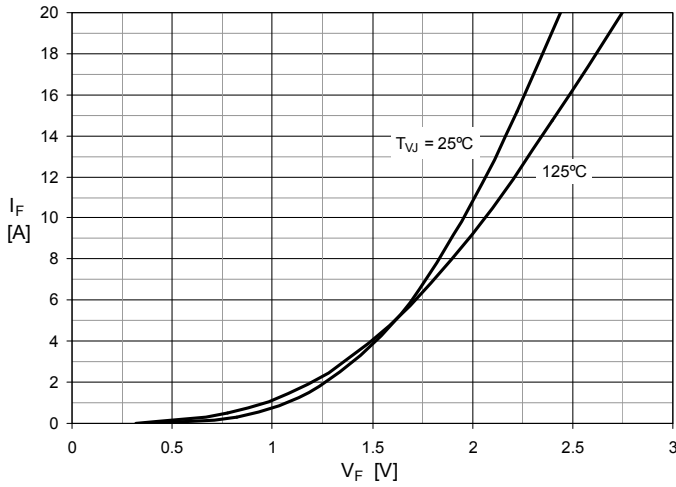

Fig. 22. Reverse Recovery Charge Q_{rr} vs. $-di_F/dt$

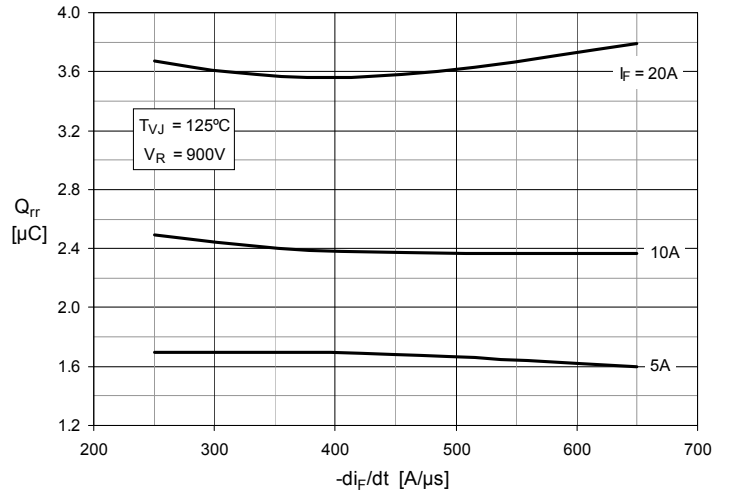

Fig. 23. Peak Reverse Current I_{RM} vs. $-di_F/dt$

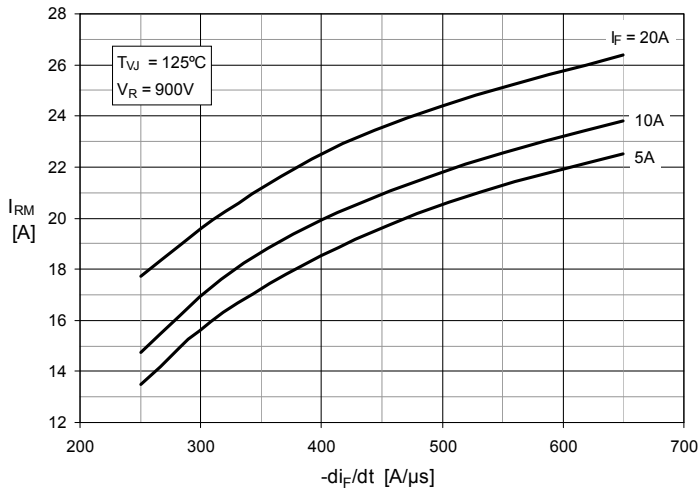

Fig. 24. Recovery Time t_{rr} vs. $-di_F/dt$

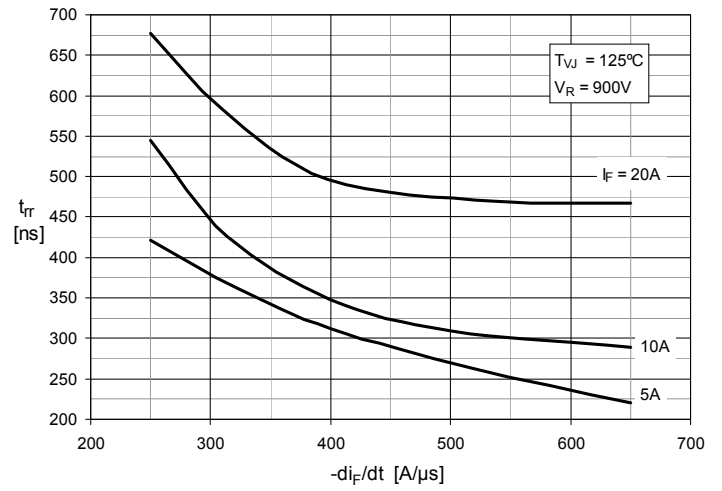

Fig. 25. Recovery Energy E_{rec} vs $-di_F/dt$

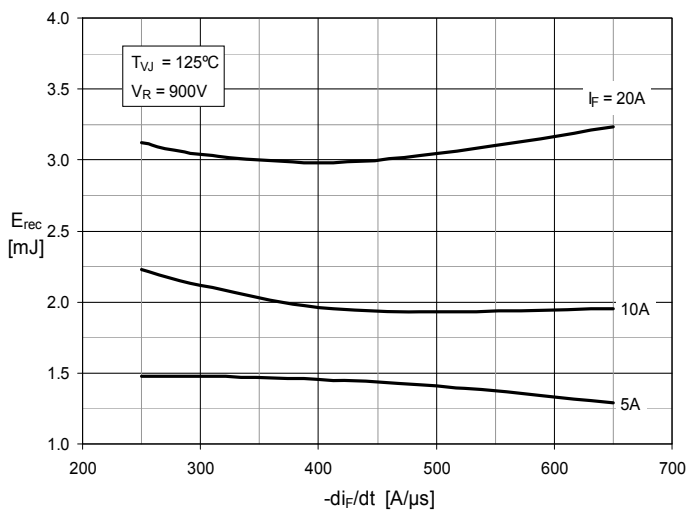
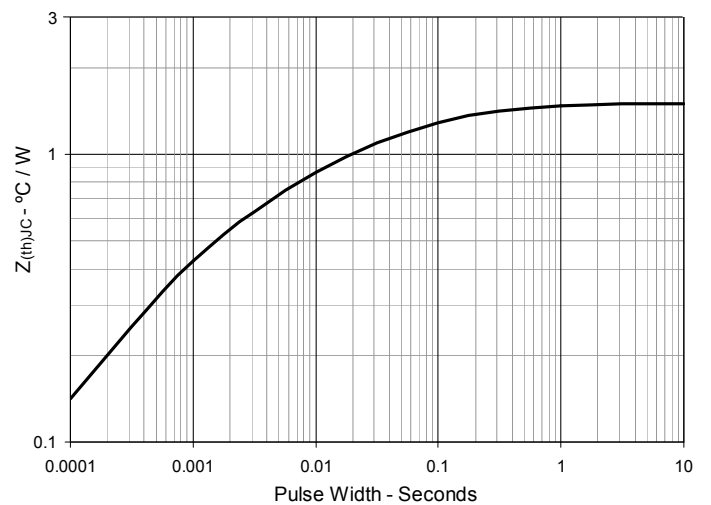

Fig. 26. Maximum Transient Thermal Impedance (Diode)





Disclaimer Notice - Information furnished is believed to be accurate and reliable. However, users should independently evaluate the suitability of and test each product selected for their own applications. Littelfuse products are not designed for, and may not be used in, all applications. Read complete Disclaimer Notice at www.littelfuse.com/disclaimer-electronics.