

# THT Power Inductors

Power Beads - PA2080NL, PA1894NL, PA2150NL, and PA2125NL Series



- Desktop/Server Vcore Inductors
- DCR Tolerance:** ±4%
- Current Rating:** Over 80Apk
- Inductance Range:** 140μH to 470μH

## Electrical Specifications @ 25°C - Operating Temperature -40°C to +130°C<sup>7</sup>

Part Number	Inductance @ 0A <sub>DC</sub> (nH ±10%)	Inductance @ I <sub>rated</sub> (nH TYP)	I <sub>rated</sub> <sup>1</sup> (A <sub>DC</sub> )	DCR <sup>2</sup> (mΩ)	Saturation Current <sup>3</sup> (A TYP)		Heating <sup>4</sup> Current (A TYP)
					25°C	100°C	
<b>PA2080NL Series - 10.5mm x 7.5mm x 8.9mm MAX</b>							
PA2080.141NL *	140	140	40	0.49 ±4.1%	85	>80	40
PA2080.161NL	165	160	40		70	60	
PA2080.191NL *	185	182	40		65	55	
PA2080.221NL	215	207	40		55	50	
<b>PA1894NL Series - 10.0mm x 9.0mm x 10.0mm MAX</b>							
PA1894.191NL	185	185	35	0.64 ±4.6%	69	55	35
PA1894.221NL *	220	220	35		63	51	
PA1894.271NL	250	250	35		53	46	
PA1894.331NL *	335	268	35		40	35	
<b>PA2150NL Series - 11.8mm x 9.0mm x 9.2mm MAX</b>							
PA2150.181NL *	180	180	37	0.50 ±4.0%	74	67	37
PA2150.231NL	235	235	37		56	50	
PA2150.261NL *	270	270	37		52	44	
PA2150.371NL	370	296	36		36	32	
PA2150.471NL *	470	376	27		27	25	
<b>PA2125NL Series - 15.9mm x 9.0mm x 9.2mm MAX</b>							
PA2125.251NL *	250	250	34	0.62 ±6.5%	68	63	34
PA2125.281NL *	285	285	34		66	56	
PA2125.331NL *	335	335	34		56	50	
PA2125.361NL	360	360	34		52	46	
PA2125.441NL	440	440	34		42	38	

# THT Power Inductors

Power Beads - PA2080NL, PA1894NL, PA2150NL, and PA2125NL Series



- Notes:**
1. The rated current as listed is either the saturation current or the heating current depending on which value is lower.
  2. The saturation current is the typical current which causes the inductance to drop by 20% at the stated ambient temperatures (25°C and 100°C). This current is determined by placing the component in the specified ambient environment and applying a short duration pulse current (to eliminate self-heating effects) to the component.
  3. The heating current is the DC current which causes the part temperature to increase by approximately 40°C.
  4. In high volt\*time applications, additional heating in the component can occur due to core losses in the inductor which may necessitate derating the current in order to limit the temperature rise of the component. To determine the approximate total losses (or temperature rise) for a given application, the coreloss and temperature rise curves can be used.
  5. The temperature of the component (ambient plus temperature rise) must be within the stated operating temperature range.

\*Contact Pulse for availability

## Mechanicals

### PA2080.XXXNL

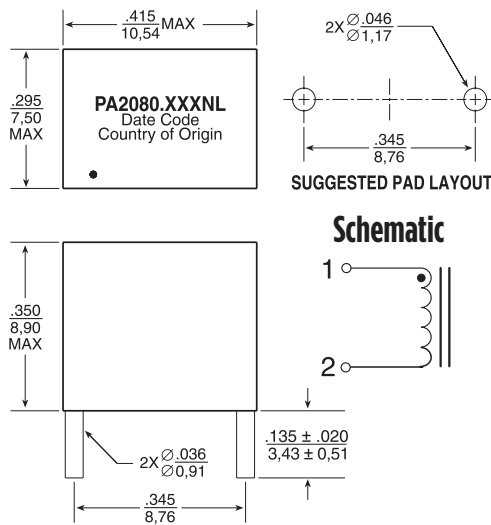

### PA1894.XXXNL

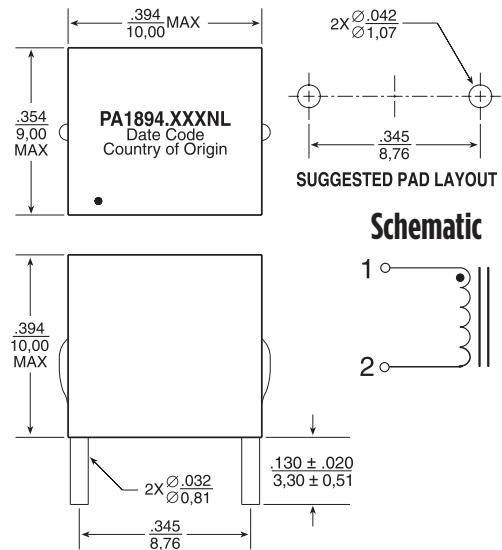

### PA2150.XXXNL

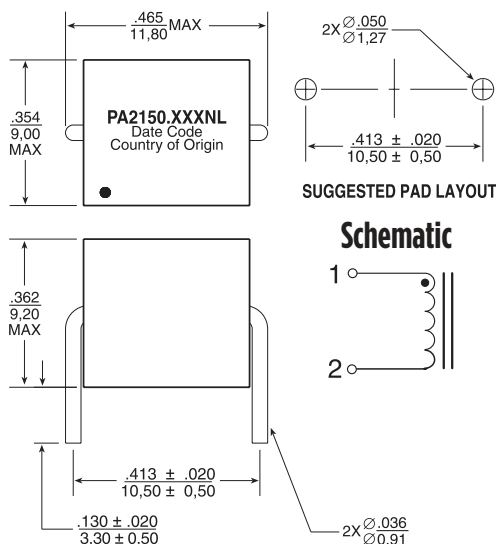

### PA2125.XXXNL

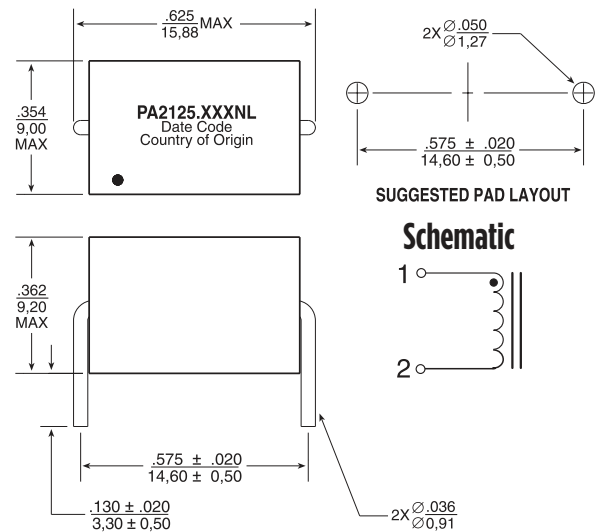

## Typical Inductance vs DC Bias for PA2080.XXXNL Series

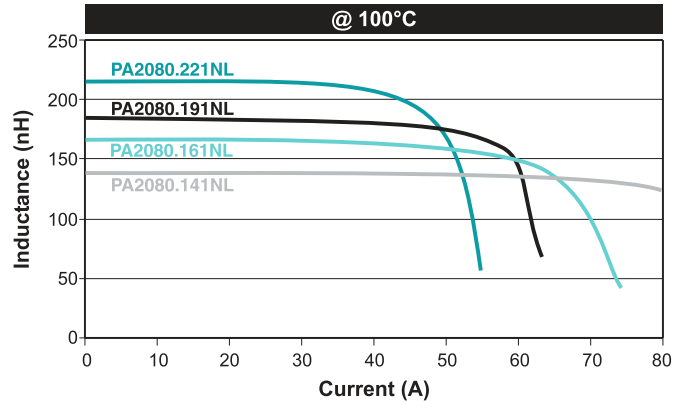
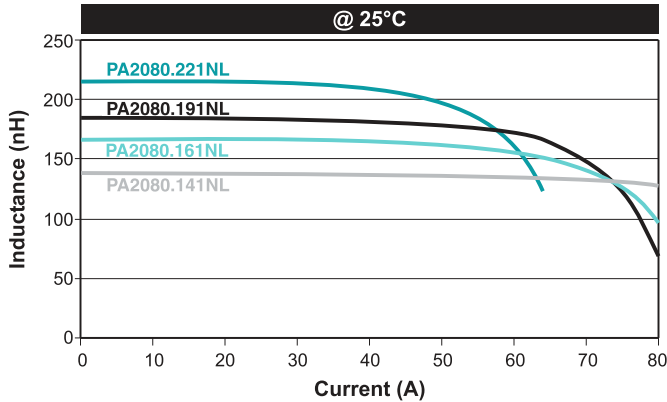

## CoreLoss (W) for PA2080.XXXNL Series

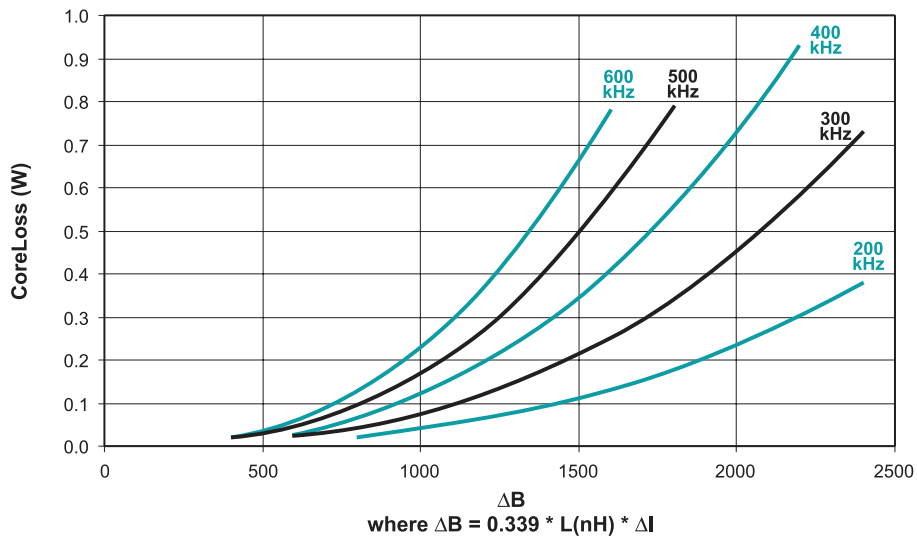

## Temp Rise vs Power Dissipation for PA2080.XXXNL Series

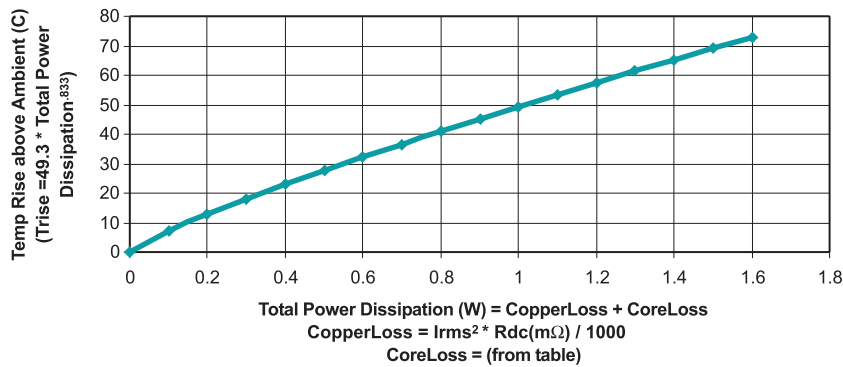

## Lvsl for PA1894.XXXNL Series

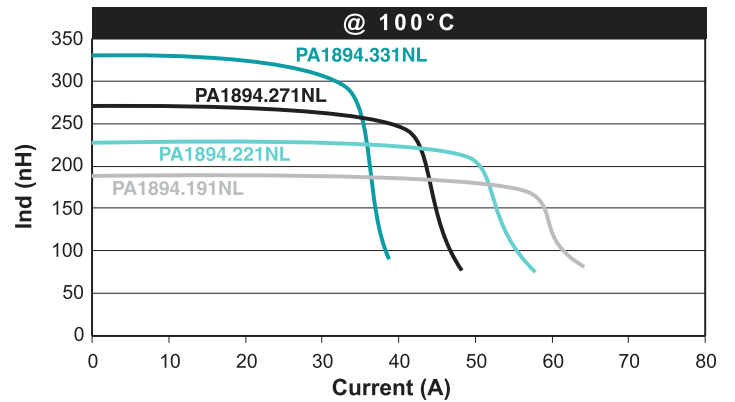
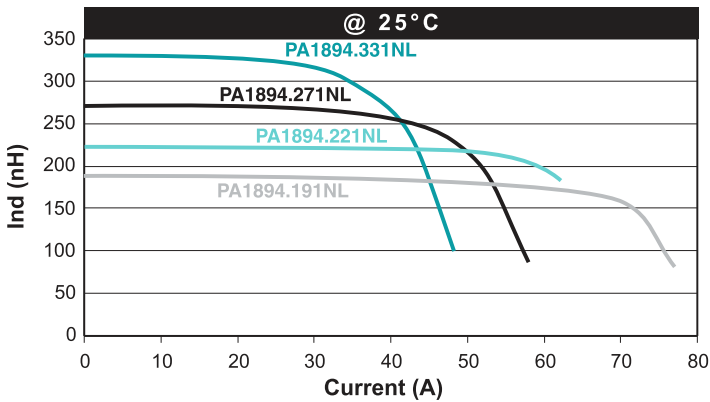

## CoreLoss (W) for PA1894.XXXNL Series

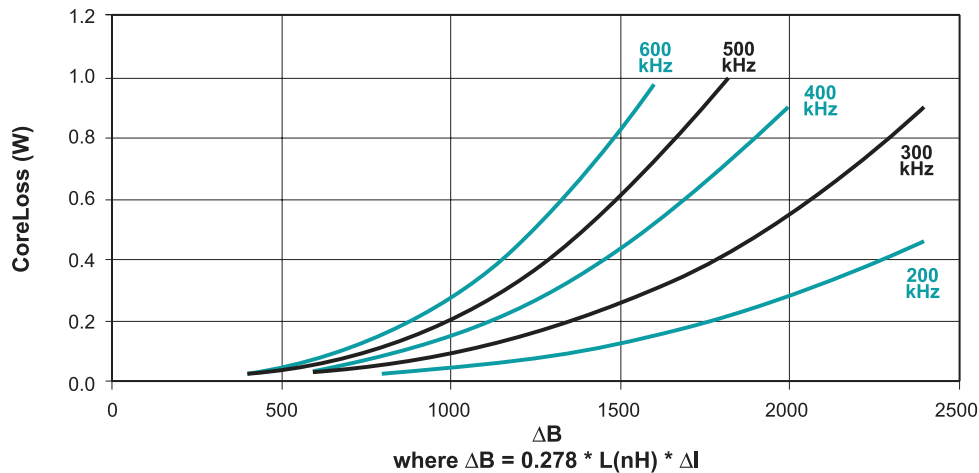

## Temp Rise vs Power Dissipation for PA1894.XXXNL Series

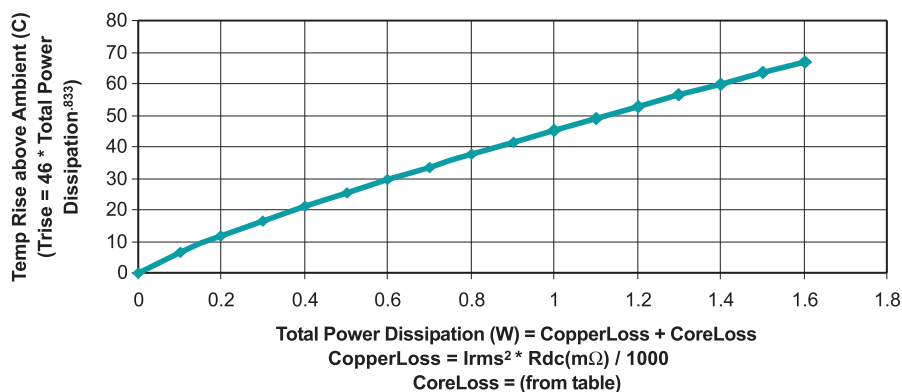

## Typical Inductance vs DC Bias for PA2150.XXXNL Series

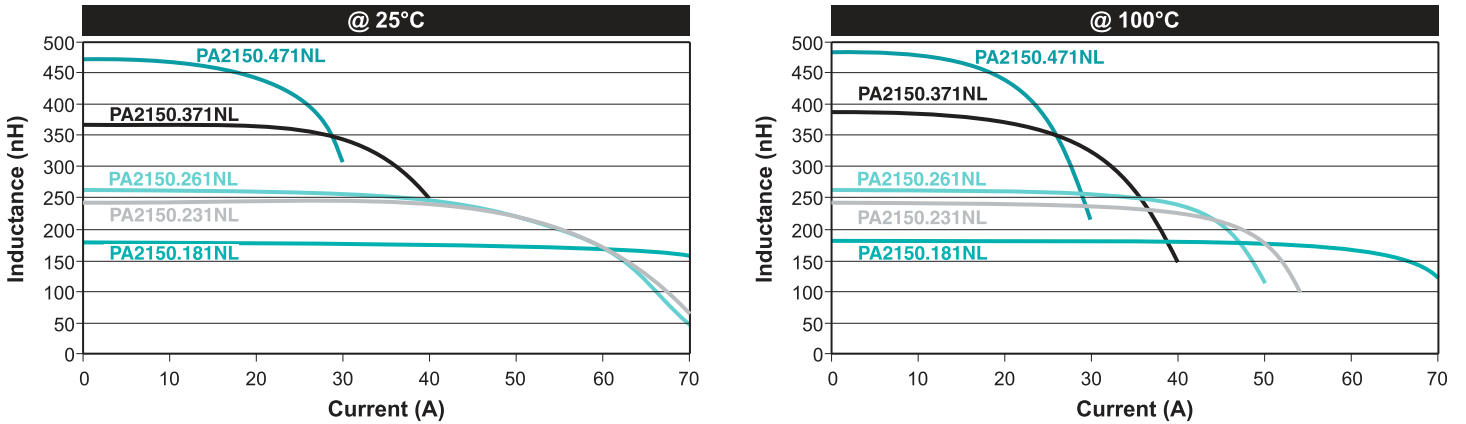

## CoreLoss (W) for PA2150.XXXNL Series

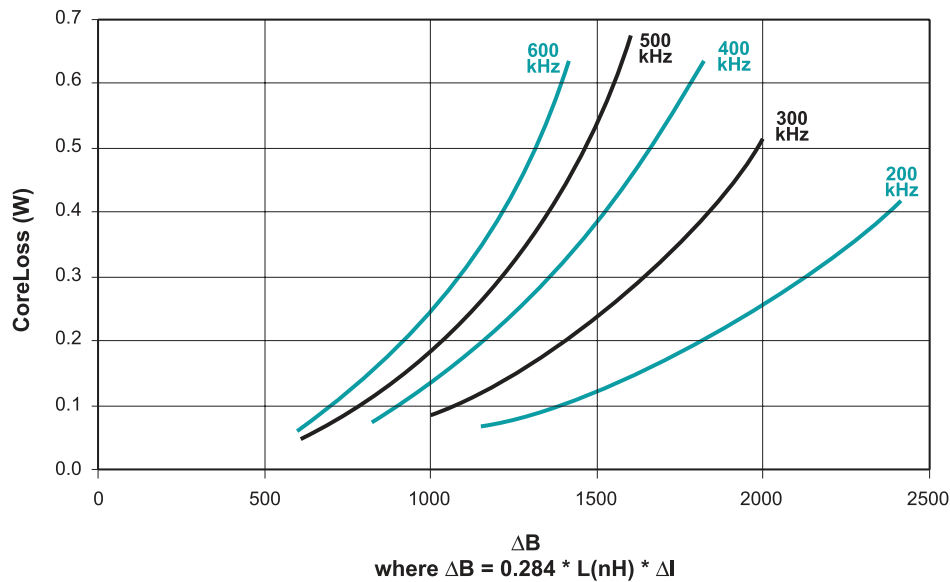

## Temp Rise vs Power Dissipation for PA2150.XXXNL Series

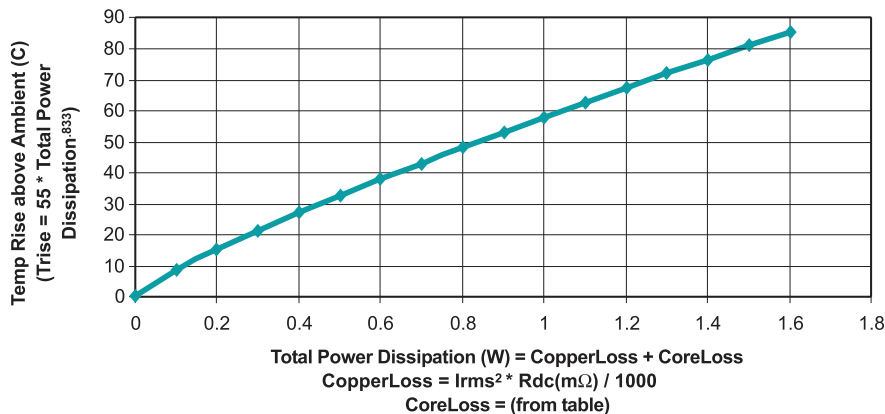

# THT Power Inductors

Power Beads - PA2080NL, PA1894NL, PA2150NL, and PA2125NL Series

## Typical Inductance vs DC Bias for PA2125.XXXNL Series

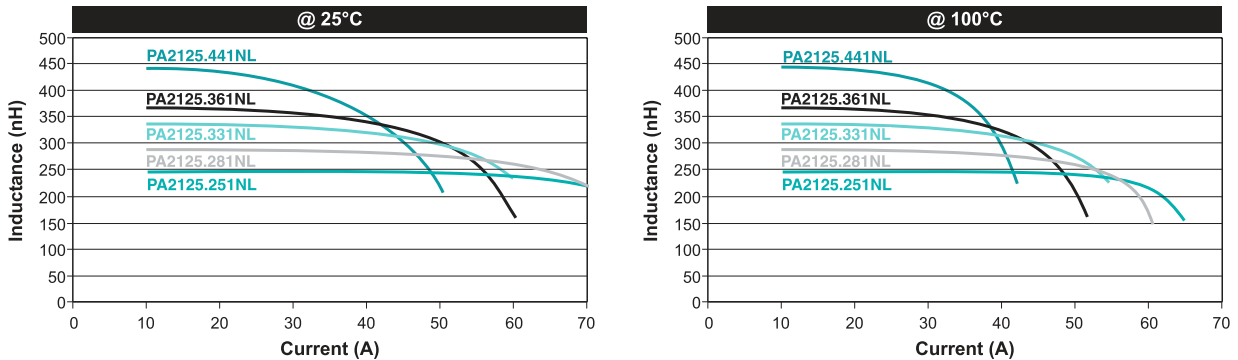

## CoreLoss (W) for PA2125.XXXNL Series

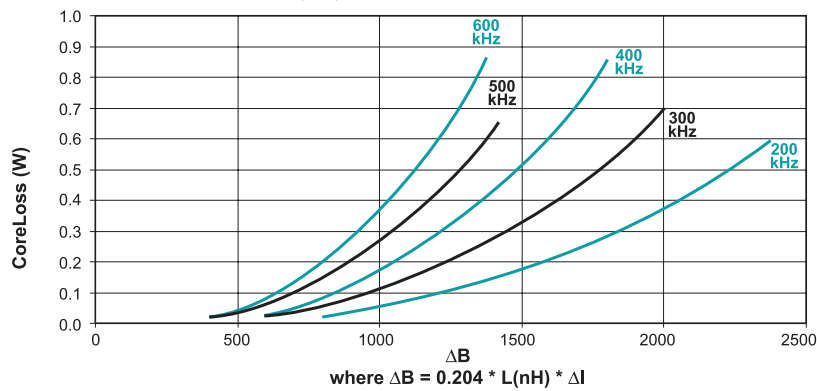

## Temp Rise vs Power Dissipation for PA2125.XXXNL Series

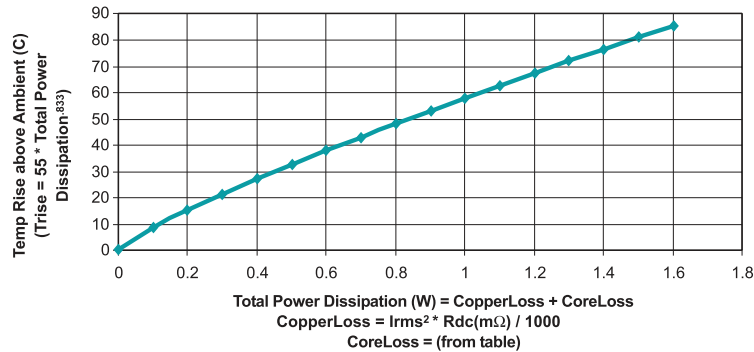

## For More Information

**Pulse Worldwide Headquarters**  
12220 World Trade Drive  
San Diego, CA  
92128  
U.S.A.

**Pulse Europe**  
Einsteinstrasse 1  
D-71083 Herrenberg  
Germany  
  
Tel: 49 7032 78060  
Fax: 49 7032 7806 135

**Pulse China Headquarters**  
B402, Shenzhen Academy of  
Aerospace Technol-  
ogy Bldg.  
10th Kejian Road  
High-Tech Zone  
Nanshan District  
Shenzen, PR China  
518057  
Tel: 86 755 3396678  
Fax: 86 755 33966700

**Pulse North China**  
Room 2704/2705  
Super Ocean Finance  
Ctr.  
2067 Yan An Road  
West  
Shanghai 200336  
China  
  
Tel: 86 21 62787060  
Fax: 86 2162786973

**Pulse South Asia**  
135 Joo Seng Road  
#03-02  
PM Industrial Bldg.  
Singapore 368363  
  
Tel: 65 6287 8998  
Fax: 65 6287 8998

**Pulse North Asia**  
3F, No. 198  
Zhongyuan Road  
Zhongli City  
Taoyuan County 320  
Taiwan R. O. C.  
Tel: 886 3 4356768  
Fax: 886 3 4356823 (Pulse)  
Fax: 886 3 4356820 (FRE)

Performance warranty of products offered on this data sheet is limited to the parameters specified. Data is subject to change without notice. Other brand and product names mentioned herein may be trademarks or registered trademarks of their respective owners. © Copyright, 2014, Pulse Electronics, Inc. All rights reserved.