

Super Bright Blue HLMP-2B85

PACKAGE DIMENSIONS

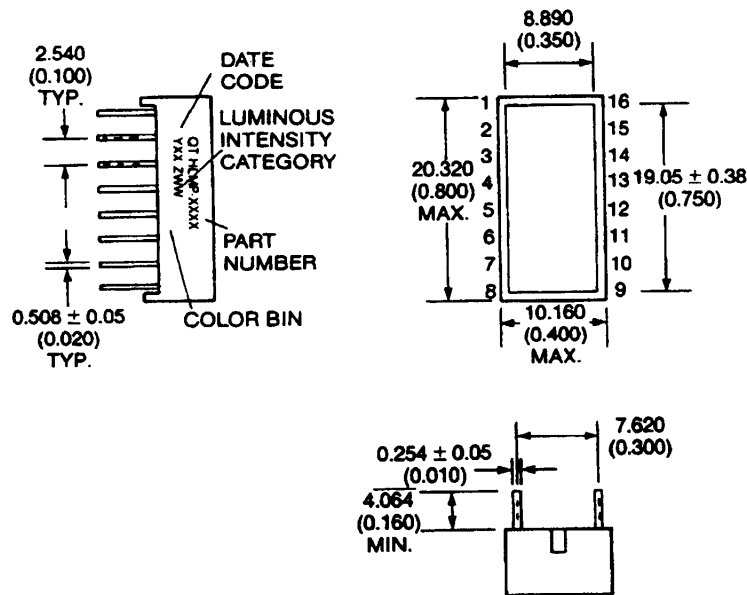

NOTE: Dimensions are in mm (inch).
Tolerances are ± 0.25 (0.1) unless otherwise noted.
All pins are 0.6 (0.02).

DESCRIPTION

The HLMP-2B85 is, large area light bar utilizing GaN on SiC LED chip.

FEATURES

- 19mm by 9mm light emitting area
- Low power requirement.
- Wide 100° viewing angle.
- High brightness and contrast
- X-Y stack able.
- Easy mounting on P.C. board.

MODEL NUMBER

Part Number	Colour	Description
HLMP-2B85	Blue	Individual LED addressable.

(For other color options, contact your local area Sales Office)

ABSOLUTE MAXIMUM RATING ($T_A = 25^\circ\text{C}$ unless otherwise specified)

Peak forward current per segment (Duty cycle 1/10, 1KHz)	Blue 100	Units mA
Continuous IF per segment	30	mA
Power dissipation per segment	150*	mW
*Derate linearly from 25°C	2.5	mW/°C
Reverse voltage VR per segments	Minimum 5V Typically 10V	Volts
Operating and storage temperature range.....	-25°C to +85°C	
Soldering time at 260°C..... (1/16" below seating plane)	3 sec	
Electrostatic Discharge Threshold (HBM).....	200 Volts	

ESD is measured by simulating ESD using a rapid avalanche energy test (RAET). The RAET procedures are designed to approximate the ESD threshold shown. See Special Handling below.

ELECTRO - OPTICAL CHARACTERISTICS ($T_A = 25^\circ\text{C}$ unless otherwise specified)

	Blue	Test Condition
Luminous Intensity/Dot Digit average (Typical)	3600ucd	$I_F = 20\text{mA}$
Forward voltage (V_F) typical	5.0V	$I_F = 20\text{ mA}$
maximum	5.5V	$I_F = 20\text{ mA}$
Peak wavelength (nm)	430nm	$I_F = 20\text{ mA}$
Spectral line half width (nm)	65nm	$I_F = 20\text{mA}$
Reverse breakdown voltage V_R	10V (typically)	$I_R = 100\mu\text{A}$

SPECIAL HANDLING INSTRUCTIONS:

PLEASE NOTE - THIS DEVICE IS SENSITIVE TO STATIC DISCHARGE - TAKE ESD PRECAUTIONS WHEN HANDLING THIS COMPONENT TO PREVENT FAILURE.

PIN CONNECTION: HLMP-2B85

Pin	Connection
1	Cathode LED 1
2	Anode LED 1
3	Anode LED 2
4	Cathode LED 2
5	Cathode LED 3
6	Anode LED 3
7	Anode LED 4
8	Cathode LED 4
9	Cathode LED 5
10	Anode LED 5
11	Anode LED 6
12	Cathode LED 6
13	Cathode LED 7
14	Anode LED 7
15	Anode LED 8
16	Cathode LED 8

SCHEMATIC: : HLMP-2B85

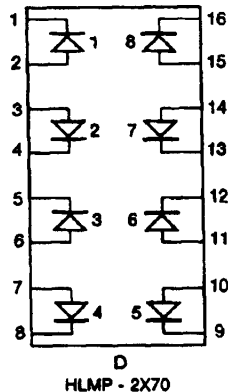

GRAPHICAL DETAIL: Blue ($T_A = 25^\circ\text{C}$ unless otherwise specified)

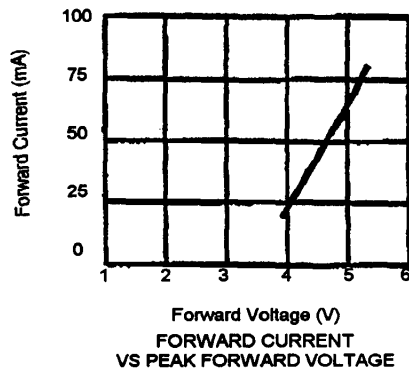
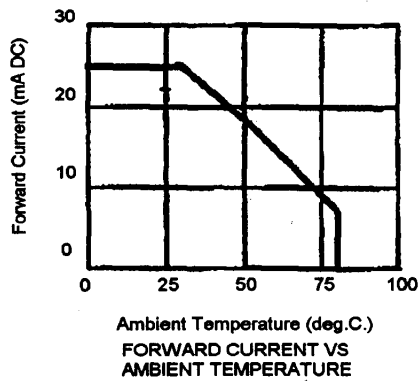
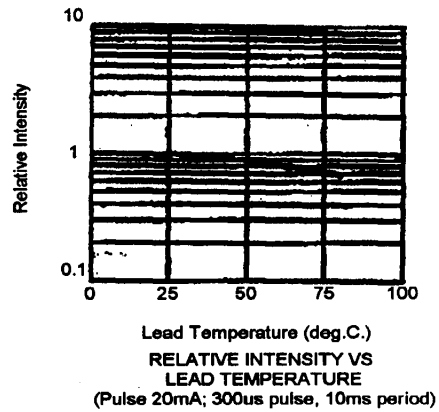
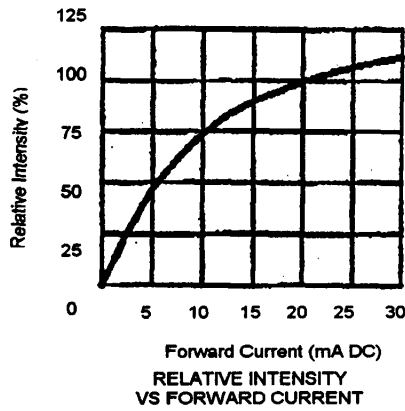
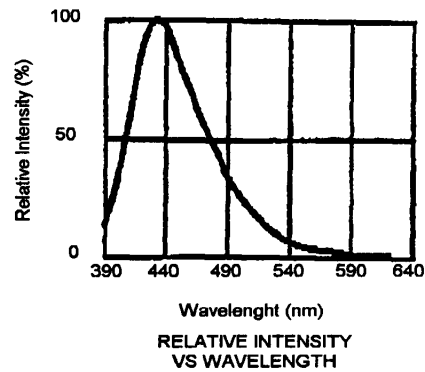
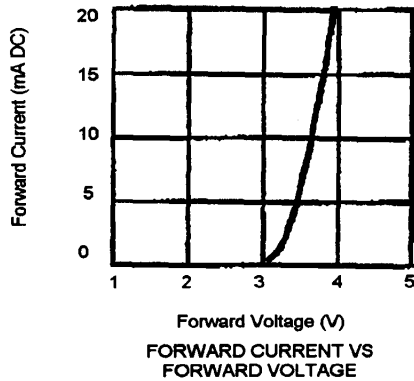

GRAPHICAL DETAIL: Blue continued ($T_A = 25^\circ\text{C}$ unless otherwise specified)

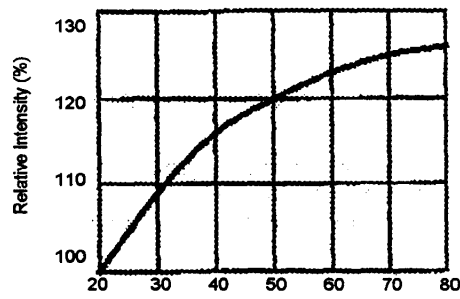

RELATIVE INTENSITY
VS PEAK FORWARD CURRENT
(300ms pulse width; 10ms period)

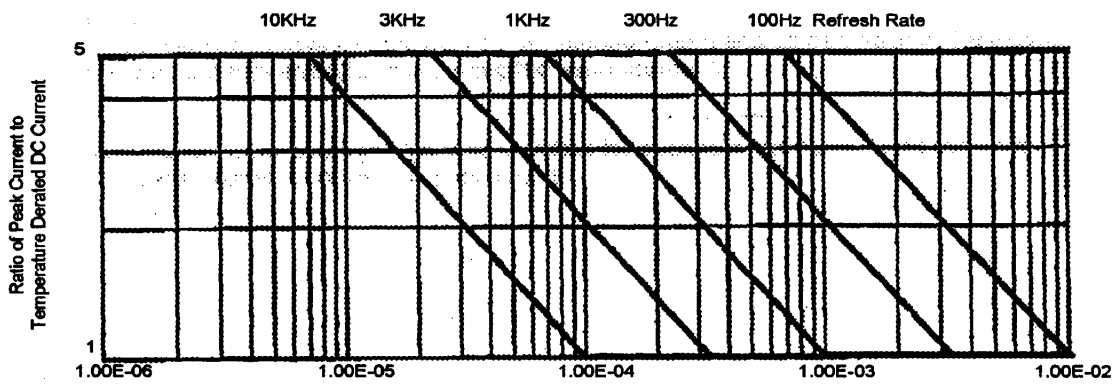

PULSE DERATING CURVE

DISCLAIMER

FAIRCHILD SEMICONDUCTOR RESERVES THE RIGHT TO MAKE CHANGES WITHOUT FURTHER NOTICE TO ANY PRODUCTS HEREIN TO IMPROVE RELIABILITY, FUNCTION OR DESIGN. FAIRCHILD DOES NOT ASSUME ANY LIABILITY ARISING OUT OF THE APPLICATION OR USE OF ANY PRODUCT OR CIRCUIT DESCRIBED HEREIN; NEITHER DOES IT CONVEY ANY LICENSE UNDER ITS PATENT RIGHTS, NOR THE RIGHTS OF OTHERS.

LIFE SUPPORT POLICY

FAIRCHILD'S PRODUCTS ARE NOT AUTHORIZED FOR USE AS CRITICAL COMPONENTS IN LIFE SUPPORT DEVICES OR SYSTEMS WITHOUT THE EXPRESS WRITTEN APPROVAL OF THE PRESIDENT OF FAIRCHILD SEMICONDUCTOR CORPORATION. As used herein:

1. Life support devices or systems are devices or systems which, (a) are intended for surgical implant into the body, or (b) support or sustain life, and (c) whose failure to perform when properly used in accordance with instructions for use provided in the labeling, can be reasonably expected to result in a significant injury of the user.
2. A critical component in any component of a life support device or system whose failure to perform can be reasonably expected to cause the failure of the life support device or system, or to affect its safety or effectiveness.