

JOHNSON™

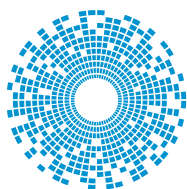

UMC Ultraminiature Connectors



cinch
CONNECTIVITY SOLUTIONS
a bel group

belfuse.com/cinch

About Bel

Bel is a publicly traded company that has been operated by the same family for over 65 years. Our history of organic growth and acquisitions have broadened our product portfolio. This has established Bel as a world leader with a diverse offering of power, protection and interconnect products. We design and manufacture these products which are primarily used in the networking, telecommunications, computing, military, aerospace, transportation and broadcasting industries. Bel's portfolio of products also finds application in the automotive, medical and consumer electronics markets.

About Cinch Connectivity Solutions

For over 100 years, Cinch Connectivity Solutions has manufactured high quality and reliable high performance connectors and cable assemblies. Cinch is recognized as a world class connectivity supplier of RF, fiber optic, hybrid, microwave components, circular, d-subminiatures, modular rectangular, electronic enclosures and cable assemblies. Cinch provides innovative solutions to the military, commercial aerospace, networking, telecommunication, test and measurement, oil and gas and other harsh environment industries. We aim to exceed our customers' expectations and continually offer innovative solutions to the rapidly changing needs of the markets and customers we serve.

Along with our parent company, Bel Fuse Inc., our mission is to provide products and services using established quality standards and to meet our customer expectations. To fulfill this objective, we strive to produce components and assemblies that embody optimum levels of reliability and performance in their design, manufacture, and delivery. Cinch Connectivity Solutions has consistently proven to be a valuable supplier to the foremost companies in its chosen industries by developing cost effective solutions for the challenges of new product development.

Table of Contents

Product Specifications	3
UMC Cable Assembly	4
UMC MMCX Cable Assembly	5
UMC SMA Cable Assembly	6
UMC SMA RP Cable Assembly	7
UMC Bare End Cable Assembly	8
UMC PCB Jack Assembly	9
UMC Accessories	10
Cross Reference	11

Product Specification

Cinch Connectivity Solutions UMC Ultraminiature Coaxial Connectors and Cable Assemblies are the answer for quality, snap-on connections built to meet your cost and performance targets.

The UMC cable plugs and jack receptacles offer 2.0mm and 2.5mm maximum mated height options with DC to 6 GHz electrical performance.

All parts are RoHS compliant and mate with the Hirose U.FL series connectors.

Applications

- Wireless LAN, Mini-PCI, and Hand-Held RF Devices
- GSM, GPRS & CDMA Mobile Phones
- PDA & Notebook Computer
- GPS
- Bluetooth
- Microwave radio and measurement

Features

- Excellent cost to performance ratio.
- Ultra-low profile connections (2.0mm & 2.5mm max. mated height).
- R/A plug to R/A plug cable assemblies on .81mm, 1.13mm, 1.32mm and 1.37mm cables.
- UMC cables available in a variety of standard off-the-shelf lengths (from 50mm to 500mm).
- Between-series cables available with standard & reverse polarity SMA plugs and Bulkhead jacks or MMCX plugs on one end of the cable and the UMC plug on the other end.
- 6. Surface-mount jack receptacles available on tape and reel (2,500 per reel).
- In-series UMC adapters available to support testing requirements.
- All cabled plugs and jack receptacles are supplied with gold plated contacts and bodies.
- UMC connectors mate with Hirose U.FL series connectors.

Electrical Characteristics

Impedance	50 Ω (Nominal)		
Temperature Range	-40°C to +90°C		
Frequency Rating	0-6 GHz		
VSWR	1.30 max (0-6 GHz)		
Contact Resistance	20 m Ω max. (Center)	20 m Ω max. (Outer, for plug)	10 m Ω max. (Outer, for receptacle)
Withstanding Voltage	200 V AC		
Insulation Resistance	500 M Ω min.		
Durability	30 cycles		
Holding Force (min.)	0.15 N (Female contact)		

LP Plug (Low Profile Plug, Plug Mated Height)

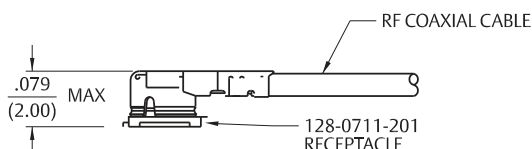

MP Plug (Medium Profile Plug)

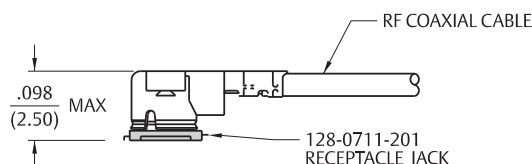

UMC Cable Assembly

Low Profile



UMC Right Angle Cable Plug to UMC Right Angle Cable Plug

Part No.	Teflon Coaxial Cable O.D.	Cable Length	Connector A	Plug Mated Height	Connector B
415-0084-050	0.81 mm	50 mm	UMC LP PLUG	2.0 mm	UMC LP PLUG
415-0084-100	0.81 mm	100 mm	UMC LP PLUG	2.0 mm	UMC LP PLUG
415-0084-150	0.81 mm	150 mm	UMC LP PLUG	2.0 mm	UMC LP PLUG
415-0084-200	0.81 mm	200 mm	UMC LP PLUG	2.0 mm	UMC LP PLUG
415-0084-250	0.81 mm	250 mm	UMC LP PLUG	2.0 mm	UMC LP PLUG
415-0084-300	0.81 mm	300 mm	UMC LP PLUG	2.0 mm	UMC LP PLUG
415-0084-500	0.81 mm	500 mm	UMC LP PLUG	2.0 mm	UMC LP PLUG

Medium Profile



UMC Right Angle Cable Plug to UMC Right Angle Cable Plug

Part No.	Teflon Coaxial Cable O.D.	Cable Length	Connector A	Plug Mated Height	Connector B
415-0085-050	0.81 mm	50 mm	UMC MP PLUG	2.5 mm	UMC MP PLUG
415-0085-100	0.81 mm	100 mm	UMC MP PLUG	2.5 mm	UMC MP PLUG
415-0085-150	0.81 mm	150 mm	UMC MP PLUG	2.5 mm	UMC MP PLUG
415-0085-200	0.81 mm	200 mm	UMC MP PLUG	2.5 mm	UMC MP PLUG
415-0085-250	0.81 mm	250 mm	UMC MP PLUG	2.5 mm	UMC MP PLUG
415-0085-300	0.81 mm	300 mm	UMC MP PLUG	2.5 mm	UMC MP PLUG
415-0085-500	0.81 mm	500 mm	UMC MP PLUG	2.5 mm	UMC MP PLUG
415-0086-050	1.13 mm	50 mm	UMC MP PLUG	2.5 mm	UMC MP PLUG
415-0086-100	1.13 mm	100 mm	UMC MP PLUG	2.5 mm	UMC MP PLUG
415-0086-150	1.13 mm	150 mm	UMC MP PLUG	2.5 mm	UMC MP PLUG
415-0086-200	1.13 mm	200 mm	UMC MP PLUG	2.5 mm	UMC MP PLUG
415-0086-250	1.13 mm	250 mm	UMC MP PLUG	2.5 mm	UMC MP PLUG
415-0086-300	1.13 mm	300 mm	UMC MP PLUG	2.5 mm	UMC MP PLUG
415-0086-500	1.13 mm	500 mm	UMC MP PLUG	2.5 mm	UMC MP PLUG
415-0087-050	1.32 mm	50 mm	UMC MP PLUG	2.5 mm	UMC MP PLUG
415-0087-100	1.32 mm	100 mm	UMC MP PLUG	2.5 mm	UMC MP PLUG
415-0087-150	1.32 mm	150 mm	UMC MP PLUG	2.5 mm	UMC MP PLUG
415-0087-200	1.32 mm	200 mm	UMC MP PLUG	2.5 mm	UMC MP PLUG
415-0087-250	1.32 mm	250 mm	UMC MP PLUG	2.5 mm	UMC MP PLUG
415-0087-300	1.32 mm	300 mm	UMC MP PLUG	2.5 mm	UMC MP PLUG
415-0087-500	1.32 mm	500 mm	UMC MP PLUG	2.5 mm	UMC MP PLUG
415-0088-050	1.37 mm	50 mm	UMC MP PLUG	2.5 mm	UMC MP PLUG
415-0088-100	1.37 mm	100 mm	UMC MP PLUG	2.5 mm	UMC MP PLUG
415-0088-150	1.37 mm	150 mm	UMC MP PLUG	2.5 mm	UMC MP PLUG
415-0088-200	1.37 mm	200 mm	UMC MP PLUG	2.5 mm	UMC MP PLUG
415-0088-250	1.37 mm	250 mm	UMC MP PLUG	2.5 mm	UMC MP PLUG
415-0088-300	1.37 mm	300 mm	UMC MP PLUG	2.5 mm	UMC MP PLUG
415-0088-500	1.37 mm	500 mm	UMC MP PLUG	2.5 mm	UMC MP PLUG

ULTRA MINIATURE CONNECTORS

UMC SMA Cable Assembly

Low Profile

UMC Right Angle Cable Plug to SMA Straight Plug



Part No.	Teflon Coaxial Cable O.D.	Cable Length	Connector A	Plug Mated Height	Connector B
415-0089-150	0.81 mm	150 mm	UMC LP PLUG	2.0 mm	SMA STR. PLUG
415-0089-250	0.81 mm	250 mm	UMC LP PLUG	2.0 mm	SMA STR. PLUG

Medium Profile

UMC Right Angle Cable Plug to SMA Straight Plug



Part No.	Teflon Coaxial Cable O.D.	Cable Length	Connector A	Plug Mated Height	Connector B
415-0090-150	0.81 mm	150 mm	UMC MP PLUG	2.5 mm	SMA STR. PLUG
415-0090-250	0.81 mm	250 mm	UMC MP PLUG	2.5 mm	SMA STR. PLUG
415-0091-150	1.37 mm	150 mm	UMC MP PLUG	2.5 mm	SMA STR. PLUG
415-0091-250	1.37 mm	250 mm	UMC MP PLUG	2.5 mm	SMA STR. PLUG

Low Profile

UMC Right Angle Cable Plug to SMA Straight Jack



Part No.	Teflon Coaxial Cable O.D.	Cable Length	Connector A	Plug Mated Height	Connector B
415-0095-150	0.81 mm	150 mm	UMC LP PLUG	2.0 mm	SMA STR BKHD. JACK
415-0095-250	0.81 mm	250 mm	UMC LP PLUG	2.0 mm	SMA STR BKHD. JACK

Medium Profile

UMC Right Angle Cable Plug to SMA Straight Jack



Part No.	Teflon Coaxial Cable O.D.	Cable Length	Connector A	Plug Mated Height	Connector B
415-0096-150	0.81 mm	150 mm	UMC MP PLUG	2.5 mm	SMA STR BKHD. JACK
415-0096-250	0.81 mm	250 mm	UMC MP PLUG	2.5 mm	SMA STR BKHD. JACK
415-0097-150	1.37 mm	150 mm	UMC MP PLUG	2.5 mm	SMA STR BKHD. JACK
415-0097-250	1.37 mm	250 mm	UMC MP PLUG	2.5 mm	SMA STR BKHD. JACK

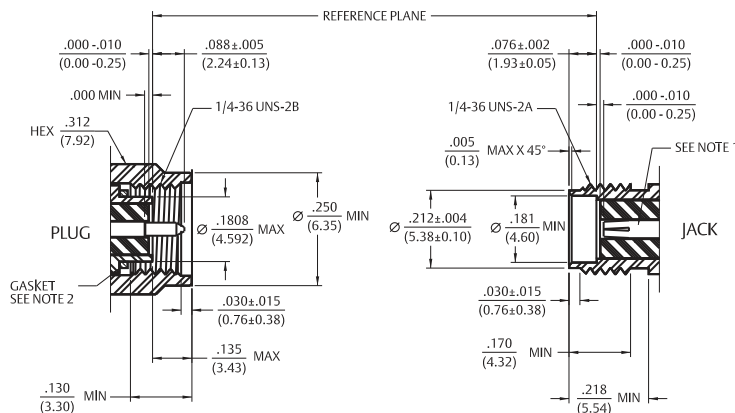

NOTES

1. ID TO MEET VSWR, CONTACT RESISTANCE AND INSERTION WITHDRAWAL FORCES WHEN MATED WITH A DIA. .0355 - .0370 PIN.
2. GASKET IS NOT SUPPLIED WITH BRASS CONNECTORS.

UMC SMA Reverse Polarity Cable Assembly

Low Profile

UMC Right Angle Cable Plug to SMA Straight Reverse Polarity Plug



Part No.	Teflon Coaxial Cable O.D.	Cable Length	Connector A	Plug Mated Height	Connector B
415-0092-150	0.81 mm	150 mm	UMC LP PLUG	2.0 mm	SMA STR. RP PLUG
415-0092-250	0.81 mm	250 mm	UMC LP PLUG	2.0 mm	SMA STR. RP PLUG

Medium Profile

UMC Right Angle Cable Plug to SMA Straight Reverse Polarity Plug



Part No.	Teflon Coaxial Cable O.D.	Cable Length	Connector A	Height	Connector B
415-0093-150	0.81 mm	150 mm	UMC MP PLUG	2.5 mm	SMA STR. RP PLUG
415-0093-250	0.81 mm	250 mm	UMC MP PLUG	2.5 mm	SMA STR. RP PLUG
415-0094-150	1.37 mm	150 mm	UMC MP PLUG	2.5 mm	SMA STR. RP PLUG
415-0094-250	1.37 mm	250 mm	UMC MP PLUG	2.5 mm	SMA STR. RP PLUG

Low Profile

UMC Right Angle Cable Plug to SMA Straight Bulkhead Rev. Polarity Jack



Part No.	Teflon Coaxial Cable O.D.	Cable Length	Connector A	Height	Connector B
415-0098-150	0.81 mm	150 mm	UMC LP PLUG	2.0 mm	SMA STR BKHD. RP JACK
415-0098-250	0.81 mm	250 mm	UMC LP PLUG	2.0 mm	SMA STR BKHD. RP JACK

Medium Profile

UMC Right Angle Cable Plug to SMA Straight Bulkhead Rev. Polarity Jack



Part No.	Teflon Coaxial Cable O.D.	Cable Length	Connector A	Height	Connector B
415-0099-150	0.81 mm	150 mm	UMC MP PLUG	2.5 mm	SMA STR BKHD. RP JACK
415-0099-250	0.81 mm	250 mm	UMC MP PLUG	2.5 mm	SMA STR BKHD. RP JACK
415-0100-150	1.37 mm	150 mm	UMC MP PLUG	2.5 mm	SMA STR BKHD. RP JACK
415-0100-250	1.37 mm	250 mm	UMC MP PLUG	2.5 mm	SMA STR BKHD. RP JACK

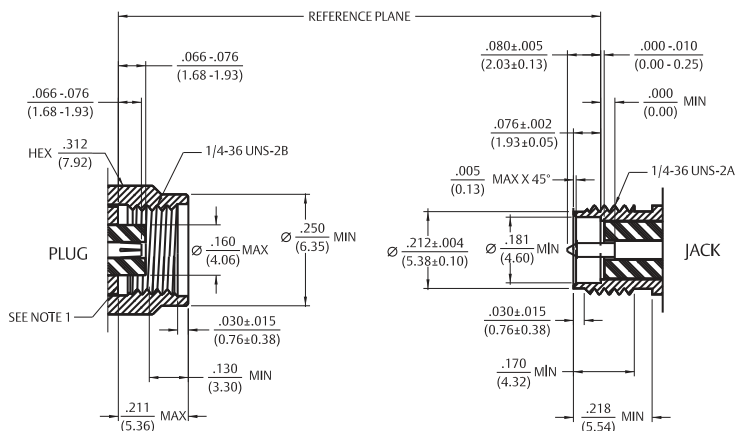

NOTES
1. ID TO MEET VSWR, CONTACT RESISTANCE AND INSERTION WITHDRAWAL FORCES WHEN MATED WITH A DIA. .0355 - .0370 PIN.

ULTRA MINIATURE CONNECTORS

UMC Bare End Assembly

0.81 mm Coaxial Cable

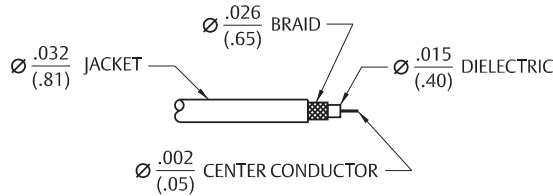

1.32 mm Coaxial Cable

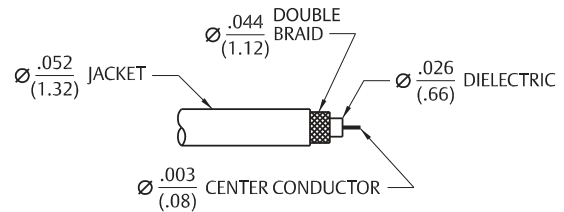

1.13 mm Coaxial Cable

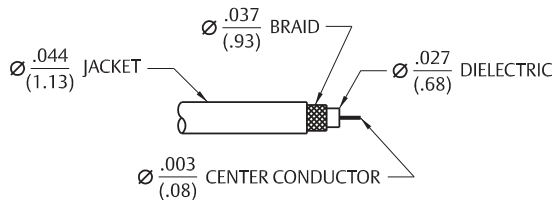

1.37 mm Coaxial Cable

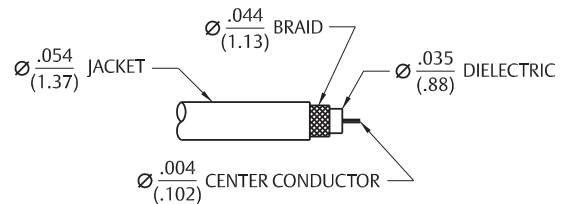

Low Profile

UMC Right Angle Cable Plug to Bare End



Part No.	Teflon Coaxial Cable O.D.	Cable Length	Connector A	Height	Connector B
415-0104-150	0.81 mm	150 mm	UMC LP PLUG	2.0 mm	BARE END
415-0104-250	0.81 mm	250 mm	UMC LP PLUG	2.0 mm	BARE END

Medium Profile

UMC Right Angle Cable Plug to Bare End



Part No.	Teflon Coaxial Cable O.D.	Cable Length	Connector A	Height	Connector B
415-0105-150	0.81 mm	150 mm	UMC MP PLUG	2.5 mm	BARE END
415-0105-250	0.81 mm	250 mm	UMC MP PLUG	2.5 mm	BARE END
415-0106-150	1.13 mm	150 mm	UMC MP PLUG	2.5 mm	BARE END
415-0106-250	1.13 mm	250 mm	UMC MP PLUG	2.5 mm	BARE END
415-0107-150	1.32 mm	150 mm	UMC MP PLUG	2.5 mm	BARE END
415-0107-250	1.32 mm	250 mm	UMC MP PLUG	2.5 mm	BARE END
415-0108-150	1.37 mm	150 mm	UMC MP PLUG	2.5 mm	BARE END
415-0108-250	1.37 mm	250 mm	UMC MP PLUG	2.5 mm	BARE END

UMC PCB Jack Receptacle

Straight Jack Receptacle - Surface Mount

Part No.	Tape & Reel
128-0711-201	2,500/REEL

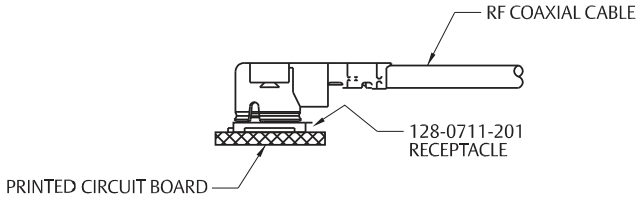

Tape and Reel

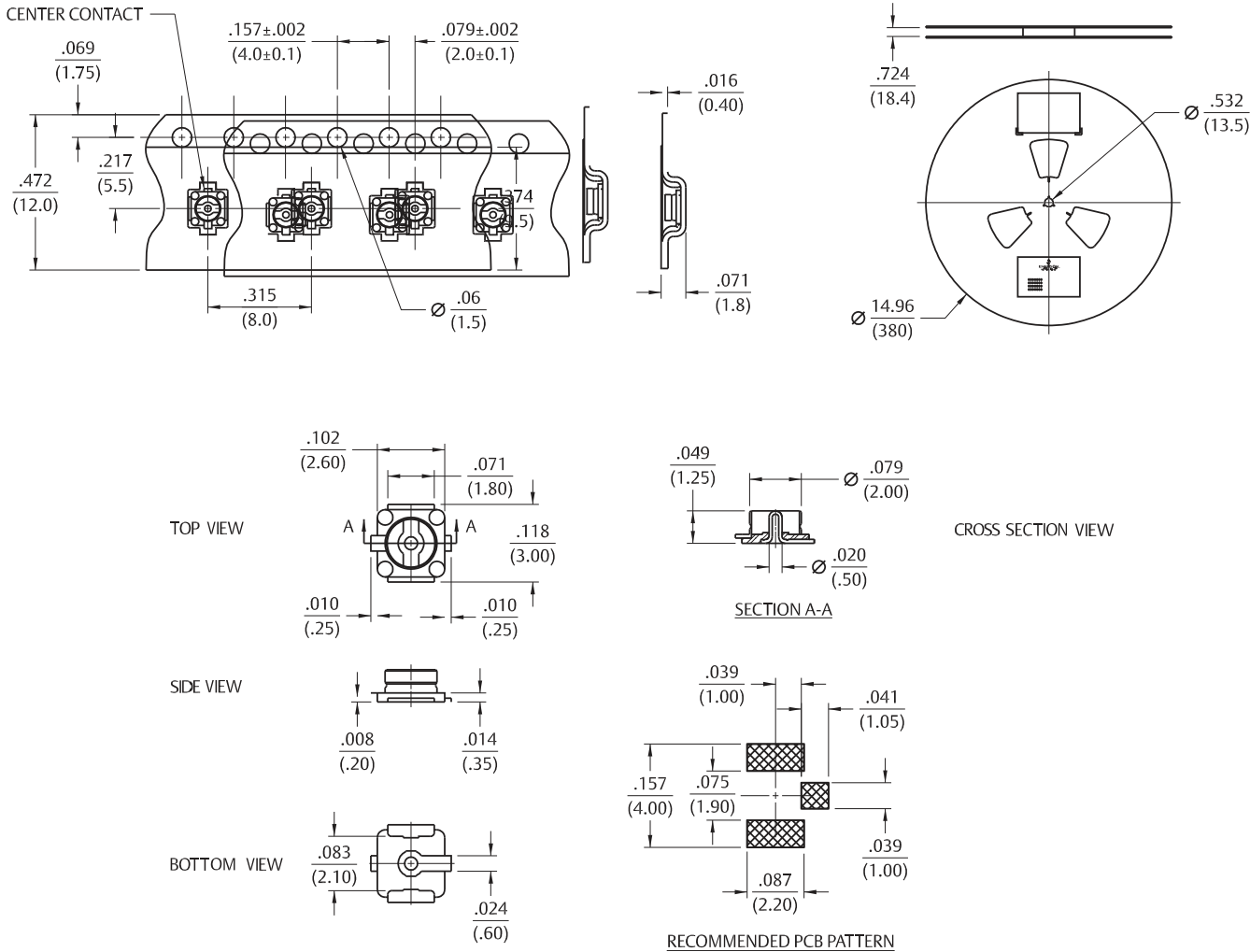

ULTRA MINIATURE CONNECTORS

UMC Accessories

SMA Conversion Adapter for Mating UMC Plugs

SMA Plug to UMC Jack

Part No.

134-1019-361

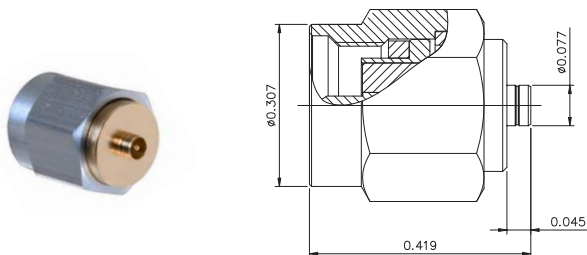

SMA Conversion Adapter for Surface Mount Jack Receptacle 128-0711-201

SMA Jack to UMC Plug

Part No.

134-1019-371

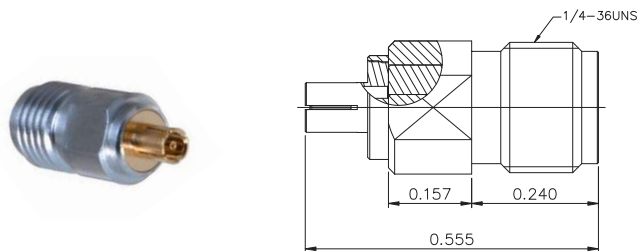

UMC Separation Key

This key is used for extraction from a mated or coupled condition

Part No.

128-0000-901



Inspection Tool for Cable Assembly

This receptacle is used for inspecting the continuity, withstand voltage and other aspects of the cable assembly product

Part No.

134-1019-381

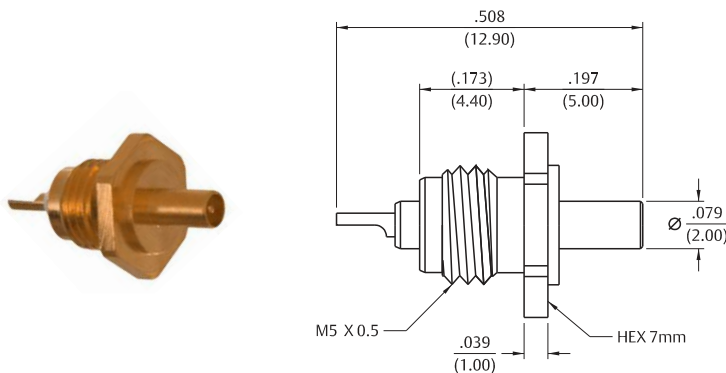

UMC to U.FL Cross Reference

Cinch Part Number	HIROSE
128-0711-201	U.FL-R-SMT(10)
415-0084-050	U.FL-2LP(V)-04N1-A-50
415-0084-100	U.FL-2LP(V)-04N1-A-100
415-0084-150	U.FL-2LP(V)-04N1-A-150
415-0084-200	U.FL-2LP(V)-04N1-A-200
415-0084-250	U.FL-2LP(V)-04N1-A-250
415-0084-300	U.FL-2LP(V)-04N1-A-300
415-0084-500	U.FL-2LP(V)-04N1-A-500
415-0085-050	U.FL-2LP-04N2-A-50
415-0085-100	U.FL-2LP-04N2-A-100
415-0085-150	U.FL-2LP-04N2-A-150
415-0085-200	U.FL-2LP-04N2-A-200
415-0085-250	U.FL-2LP-04N2-A-250
415-0085-300	U.FL-2LP-04N2-A-300
415-0085-300	U.FL-2LP-04N2-A-500
415-0086-050	U.FL-2LP-068N2-A-50
415-0086-100	U.FL-2LP-068N2-A-100
415-0086-150	U.FL-2LP-068N2-A-150
415-0086-200	U.FL-2LP-068N2-A-200
415-0086-250	U.FL-2LP-068N2-A-250
415-0086-300	U.FL-2LP-068N2-A-300
415-0086-500	U.FL-2LP-068N2-A-500
415-0087-050	U.FL-2LP-066J2-A-50

Cinch Part Number	HIROSE
415-0087-100	U.FL-2LP-066J2-A-100
415-0087-150	U.FL-2LP-066J2-A-150
415-0087-200	U.FL-2LP-066J2-A-200
415-0087-250	U.FL-2LP-066J2-A-250
415-0087-300	U.FL-2LP-066J2-A-300
415-0087-500	U.FL-2LP-066J2-A-500
415-0088-050	U.FL-2LP-088K2T-A-50
415-0088-100	U.FL-2LP-088K2T-A-100
415-0088-150	U.FL-2LP-088K2T-A-150
415-0088-200	U.FL-2LP-088K2T-A-200
415-0088-250	U.FL-2LP-088K2T-A-250
415-0088-300	U.FL-2LP-088K2T-A-300
415-0088-500	U.FL-2LP-088K2T-A-500
415-0104-150	U.FL-LP(V)-04N1-A-150
415-0104-250	U.FL-LP(V)-04N1-A-250
415-0105-150	U.FL-LP-04N2-A-150
415-0105-250	U.FL-LP-04N2-A-250
415-0106-150	U.FL-LP-068N2-A-150
415-0106-250	U.FL-LP-068N2-A-250
415-0107-150	U.FL-LP-066J2-A-150
415-0107-250	U.FL-LP-066J2-A-250
415-0108-150	U.FL-LP-088K2T-A-150
415-0108-250	U.FL-LP-088K2T-A-250

UMC Family: UMC MP, LP, ULP Competition with other Supplier's Product

Model Name	Cinch / Johnson			HIROSE		
	UMC MP	UMC LP	UMC ULP	U.FL-LP-040/066	U.FL-LP(V)-040	W.FL-LP-040
Mated Height (Max.)	2.5mm	2.0mm	1.55mm	2.5mm	2.0mm	1.55mm
Termination Style	Mechanical Termination			Soldering		
Plating of Shell	Gold	Gold	Gold	Silver	Silver	Silver
Plating of Contact	Gold	Gold	Gold	Gold	Gold	Gold
Applicable Coaxial Cable (Diameter)	AWG30(1.37mm)					
	AWG32(1.32mm)			AWG32(1.32mm)		
	AWG32(1.13mm)	AWG36(0.81mm)	AWG36(0.81mm)	AWG36 (0.81mm)	AWG36(0.81mm)	AWG36(0.81mm)
	AWG36(0.81mm)					
Frequencies	DC to 6GHz			DC to 6GHz		

UMC Compatibility Table Cinch Johnson Vs HIROSE

UMC Family	Mated Height (mm)	AWG (O.D. mm)	Cinch / Johnson		HIROSE	
			Plating (Contact / Ground)	Part No.	Plating (Contact / Ground)	Product No.
UMC Receptacle	2.5	N/A	Gold	128-0711-201	Gold/Silver	U.FL-R-SMT (10)
UMC MP Plug	2.5	30 (1.37)	Gold	415-0088-xxx	Gold/Silver	U.FL-LP-088
		32 (1.32)	Gold	415-0087-xxx	Gold/Silver	U.FL-LP-066
UMC MP Plug	2.5	32 (1.13)	Gold	415-0086-xxx	Gold/Silver	U.FL-LP-066
		36 (0.81)	Gold	415-0085-xxx	Gold/Silver	U.FL-LP-040
UMC LP Plug	2.0	36 (0.81)	Gold	415-0084-xxx	Gold/Silver	U.FL-LP(V)-040
UMC ULP Plug	1.55	N/A	Gold	415-0109-xxx	Gold/Silver	CL-331-0482-6-10



About Cinch Connectivity Solutions

In operation since 1917, Cinch supplies high quality, high performance connectors and cables globally to the Aerospace, Military/Defense, Commercial Transportation, Oil & Gas, High End Computer, and other markets. We provide custom solutions with our creative, hands on engineering and end to end approach.

Our diverse product offerings include: connectors, enclosures and cable assemblies utilizing multiple contact technologies including copper and fiber optics. Our product engineering and development activities employ cutting edge technologies for design and modeling, and our various technologies and expertise enable us to deliver custom solutions and products for our strategic partnerships.

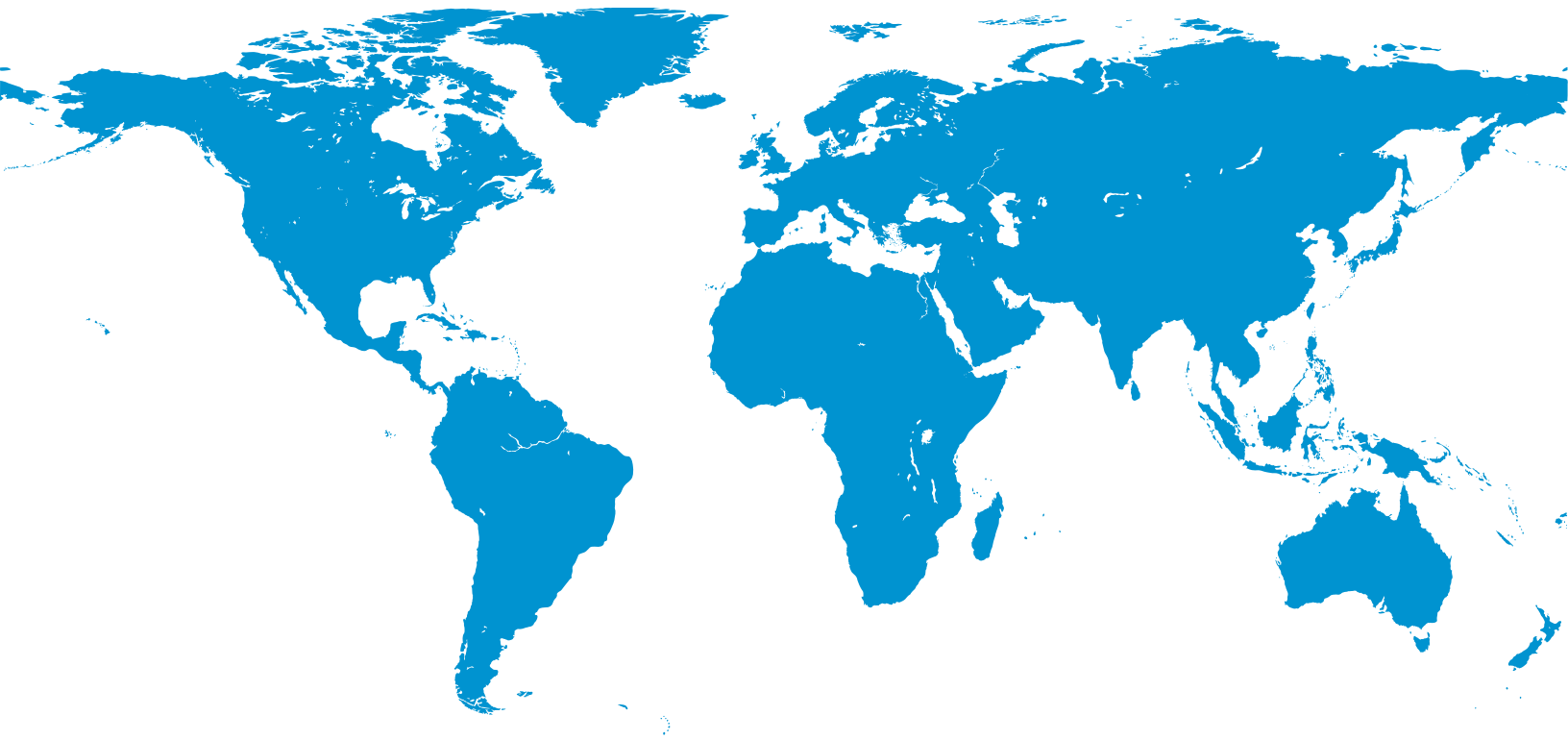

For more information, please contact us:

North America

+1 507.833.8822

ccsorders@us.cinch.com

Asia-Pacific

+86 21 5442 7668

ccs.asia.sales@as.cinch.com

Europe, Middle East

+44 (0) 1245 342060

CinchConnectivity@eu.cinch.com

belfuse.com/cinch.com



cinch
CONNECTIVITY SOLUTIONS

a bel group