

Turbo 2 ultrafast high voltage rectifier

Datasheet – production data

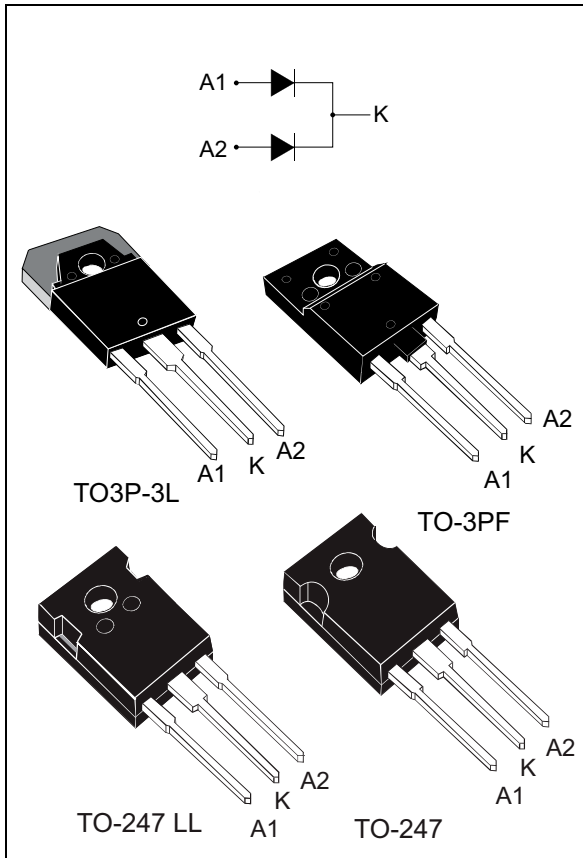

Description

This device uses ST Turbo 2 600 V technology and is specially suited for use as a boost diode in air conditioning equipment as continuous mode interleaved power factor correction.

The device is also intended for use as a free wheeling diode in power supplies and other power switching applications.

Table 1. Device summary

Symbol	Value
$I_{F(AV)}$	2 x 30 A
V_{RRM}	600 V
t_{rr} (typ)	40 ns
V_F (typ)	1.4 V
T_j	175 °C

Features

- Ultrafast switching
- Low reverse current
- Low thermal resistance
- Reduces switching and conduction losses
- Insulated package TO-3PF:
 - Insulated voltage: 2500 V_{DC}

1 Characteristics

Table 2. Absolute ratings (limiting values per diode at 25 °C, unless otherwise specified)

Symbol	Parameter		Value	Unit
V_{RRM}	Repetitive peak reverse voltage		600	V
$I_{F(RMS)}$	Forward rms current		50	A
$I_{F(AV)}$	Average forward current	Per diode	30	A
		Per device	60	
I_{FSM}	Surge non repetitive forward current	$t_p = 10$ ms sinusoidal	280	A
T_{stg}	Storage temperature range		-65 to +175	°C
T_j	Maximum operating junction temperature		175	°C

Table 3. Thermal parameters

Symbol	Parameter		Value	Unit
$R_{th(j-c)}$	Junction to case (TO3P-3L, TO-247, TO-247 LL)	Per diode	0.9	°C/W
		Total	0.55	
$R_{th(c)}$	Coupling (TO3P-3L, TO-247, TO-247 LL)		0.2	
$R_{th(j-c)}$	Junction to case (TO-3PF)	Per diode	2.8	
		Total	2.2	
$R_{th(c)}$	Coupling (TO-3PF)		1.6	

Table 4. Static electrical characteristics (per diode)

Symbol	Parameter	Test conditions		Min.	Typ.	Max.	Unit
$I_R^{(1)}$	Reverse leakage current	$T_j = 25$ °C	$V_R = V_{RRM}$			10	μA
		$T_j = 150$ °C			40	400	
$V_F^{(2)}$	Forward voltage drop	$T_j = 25$ °C	$I_F = 30$ A			1.75	V
		$T_j = 150$ °C			1.07	1.40	
		$T_j = 25$ °C	$I_F = 60$ A			2	
		$T_j = 150$ °C			1.32	1.7	

1. Pulse test: $t_p = 5$ ms, $\delta < 2\%$
2. Pulse test: $t_p = 380$ μs, $\delta < 2\%$

To evaluate the conduction losses use the following equation:

$$P = 1.1 \times I_{F(AV)} + 0.01 I_{F(RMS)}^2$$

Table 5. Dynamic characteristics (per diode)

Symbol	Parameter	Test conditions		Min.	Typ.	Max.	Unit
t_{rr}	Reverse recovery time	$T_j = 25\text{ }^\circ\text{C}$	$I_F = 0.5\text{ A}, I_{rr} = 0.25\text{ A}, I_R = 1\text{ A}$			40	ns
			$I_F = 1\text{ A}, V_R = 30\text{ V}, dI_F/dt = -50\text{ A}/\mu\text{s}$		50	70	
I_{RM}	Reverse recovery current	$T_j = 125\text{ }^\circ\text{C}$	$I_F = 30\text{ A}, V_R = 400\text{ V}, dI_F/dt = -100\text{ A}/\mu\text{s}$		6.5	9	A
t_{fr}	Forward recovery time	$T_j = 25\text{ }^\circ\text{C}$	$I_F = 30\text{ A}, V_{FR} = 1.5\text{ V}, dI_F/dt = +200\text{ A}/\mu\text{s}$			100	ns
V_{FP}	Forward recovery voltage				2.5		V

Figure 1. Average forward power dissipation versus average forward current (per diode)

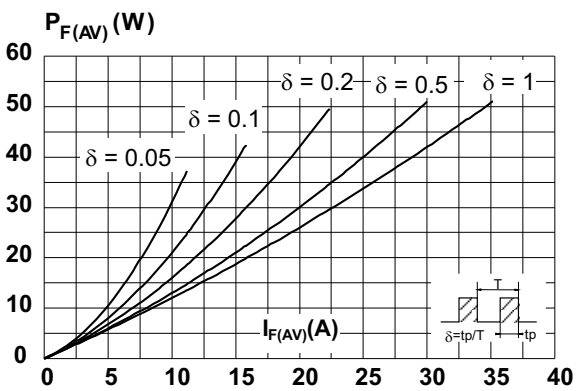

Figure 2. Forward voltage drop versus forward current (typical values, per diode)

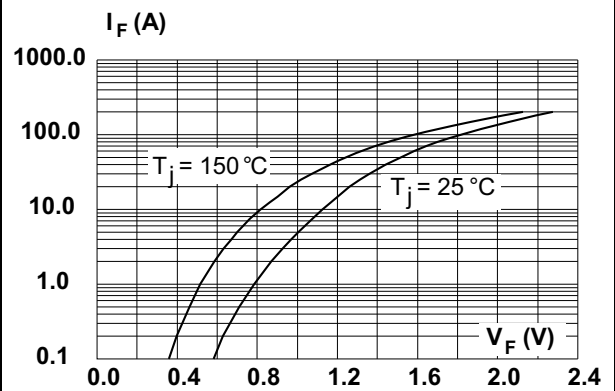

Figure 3. Forward voltage drop versus forward current (maximum values, per diode)

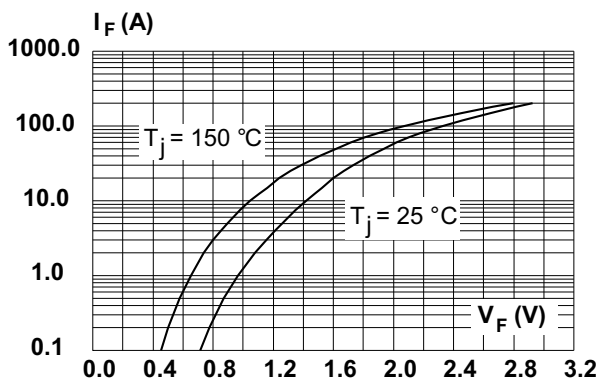

Figure 4. Relative variation of thermal impedance, junction to case, versus pulse duration (TO3P-3L, TO-247, TO-247LL)

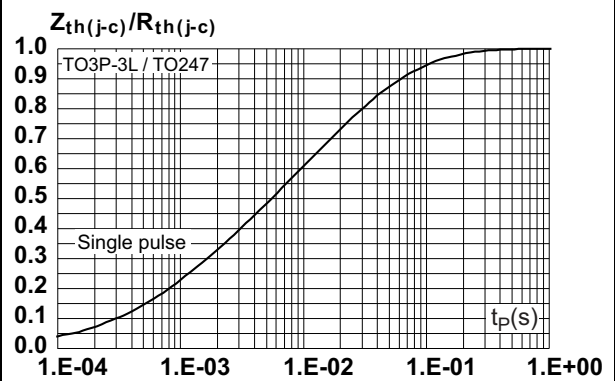

Figure 5. Relative variation of thermal impedance, junction to case, versus pulse duration (TO-3PF)

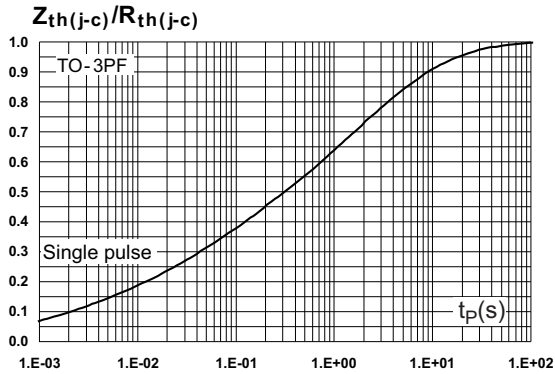

Figure 6. Peak reverse recovery current versus di_F/dt (typical values, per diode)

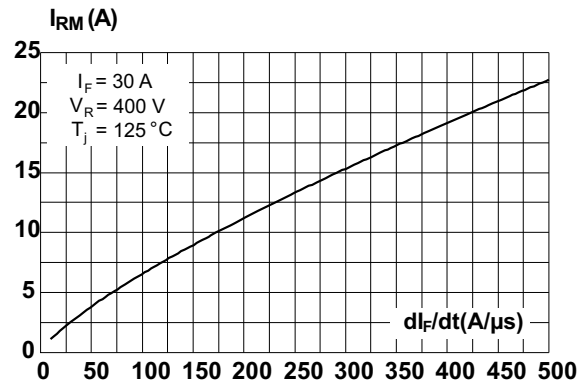

Figure 7. Reverse recovery time versus di_F/dt (typical values, per diode)

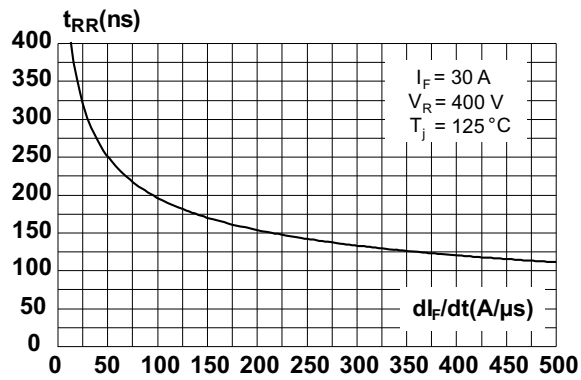

Figure 8. Reverse recovery charges versus di_F/dt (typical values, per diode)

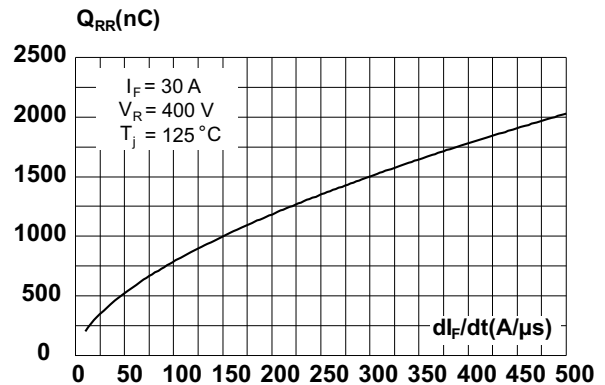

Figure 9. Reverse recovery softness factor versus di_F/dt (typical values, per diode)

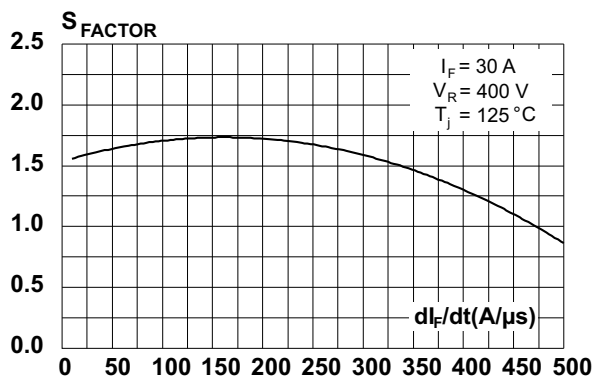

Figure 10. Relative variations of dynamic parameters versus junction temperature

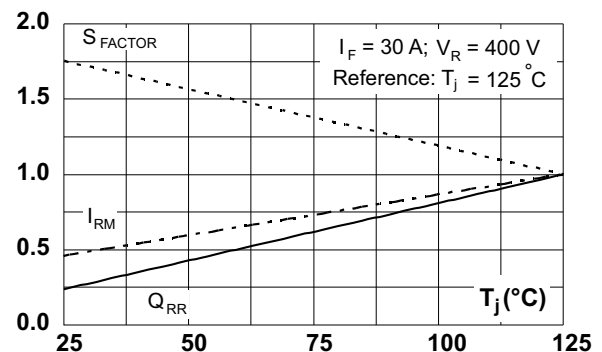

Figure 11. Transient peak forward voltage versus di_F/dt (typical values, per diode)

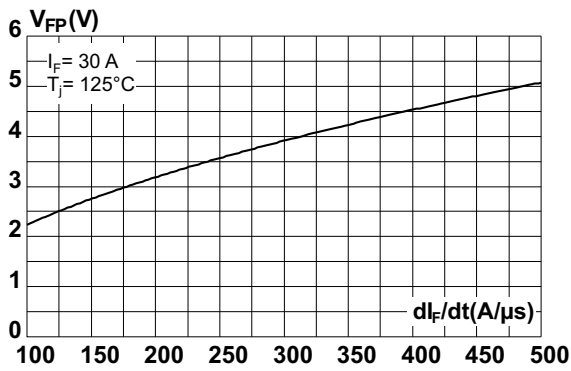

Figure 12. Forward recovery time versus di_F/dt (typical values, per diode)

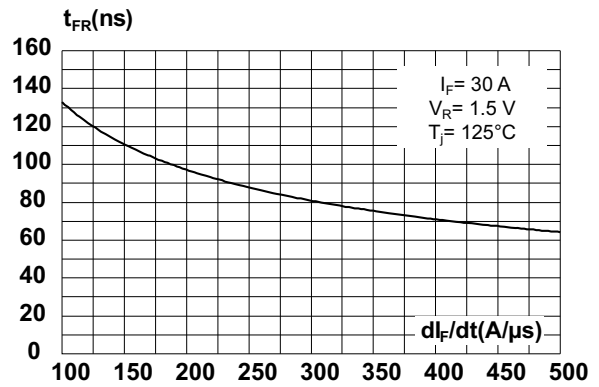
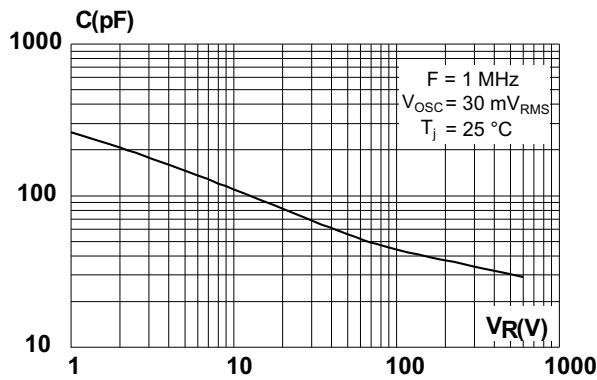

Figure 13. Junction capacitance versus reverse voltage applied (typical values, per diode)



2 Package information

- Epoxy meets UL94, V0
- Cooling method: by conduction (C)
- Recommended torque: (TO3P-3L, TO-3PF) 0.4 to 0.6 N·m, (TO-247) 0.5 to 1.0 N·m
- Maximum torque value (TO-247 LL): 1.0 N·m

In order to meet environmental requirements, ST offers these devices in different grades of ECOPACK® packages, depending on their level of environmental compliance. ECOPACK® specifications, grade definitions and product status are available at: www.st.com. ECOPACK® is an ST trademark.

2.1 TO3P-3L package information

Figure 14. TO3P-3L package outline

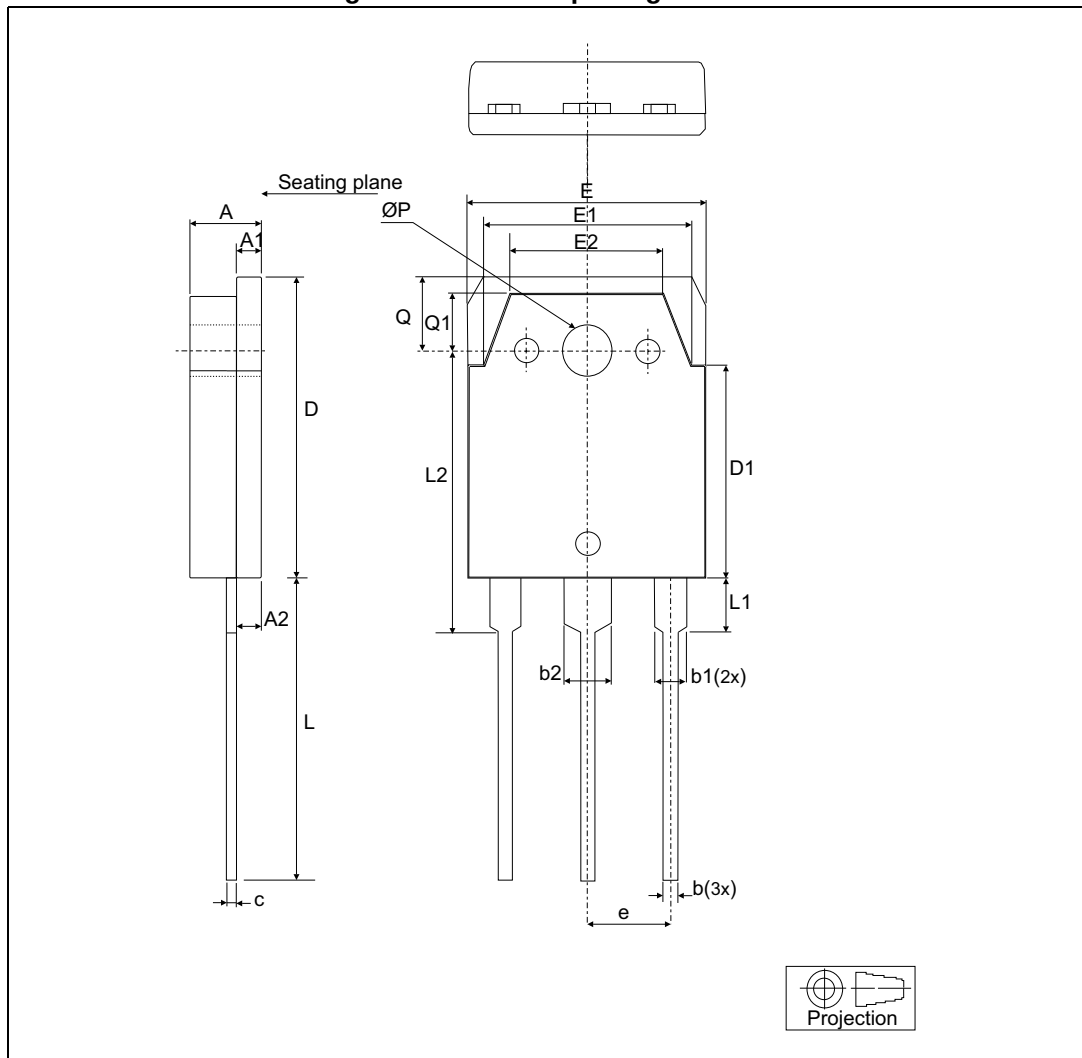

Table 6. TO3P-3L package mechanical data

Ref.	Dimensions					
	Millimeters			Inches		
	Min.	Typ.	Max.	Min.	Typ.	Max.
A	4.6		5	0.18		0.19
A1	1.45	1.5	1.65	0.05	0.06	0.06
A2	1.20	1.40	1.60	0.04	0.05	0.06
b	0.80	1	1.20	0.03	0.04	0.05
b1	1.80		2.20	0.07		0.08
b2	2.80		3.20	0.11		0.12
c	0.55	0.60	0.75	0.02	0.02	0.03
D	19.70	19.90	20.10	0.77	0.78	0.79
D1		13.90			0.54	
E	15.40		15.80	0.60		0.62
E1		13.60			0.53	
E2		9.60			0.38	
e	5.15	5.45	5.75	0.20	0.21	0.22
L	19.50	20	20.50	0.76	0.78	0.80
L1		3.50			0.14	
L2	18.20	18.40	18.60	0.71	0.72	0.73
ØP	3.10		3.30	0.12		0.13
Q		5			0.19	
Q1		3.80			0.15	

2.2 TO-3PF package information

Figure 15. TO-3PF package outline

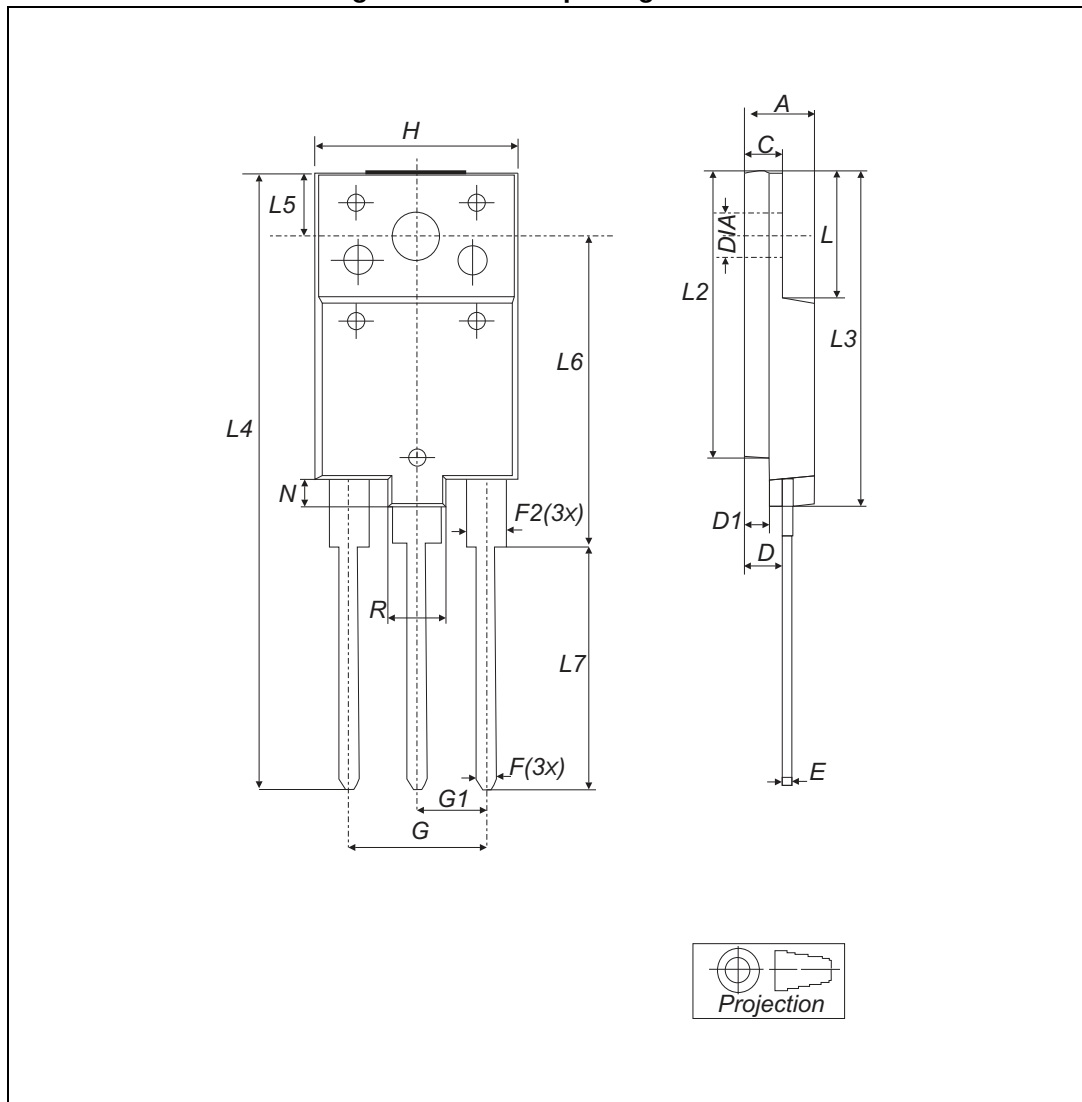

Table 7. TO-3PF mechanical data

Ref.	Dimensions					
	Millimeters			Inches		
	Min.	Typ.	Max.	Min.	Typ.	Max.
A	5.30		5.70	0.2		0.22
C	2.80		3.20	0.11		0.12
D	3.10		3.50	0.12		0.13
D1	1.80		2.20	0.07		0.08
E	0.80		1.10	0.03		0.04
F	0.65		0.95	0.025		0.037
F2	1.80		2.20	0.07		0.08
G	10.30		11.50	0.40		0.45
G1		5.45			0.21	
H	15.30		15.70	0.60		0.61
L	9.80	10	10.20	0.38	0.39	0.40
L2	22.80		23.20	0.89		0.91
L3	26.30		26.70	1.03		1.05
L4	43.20		44.40	1.70		1.74
L5	4.30		4.70	0.16		1.18
L6	24.30		24.70	0.95		0.97
L7	14.60		15	0.57		0.59
N	1.80		2.20	0.07		0.08
R	3.80		4.20	0.14		0.16
Dia	3.40		3.80	0.13		0.15

2.3 TO-247 LL package information

Figure 16. TO-247 LL package outline

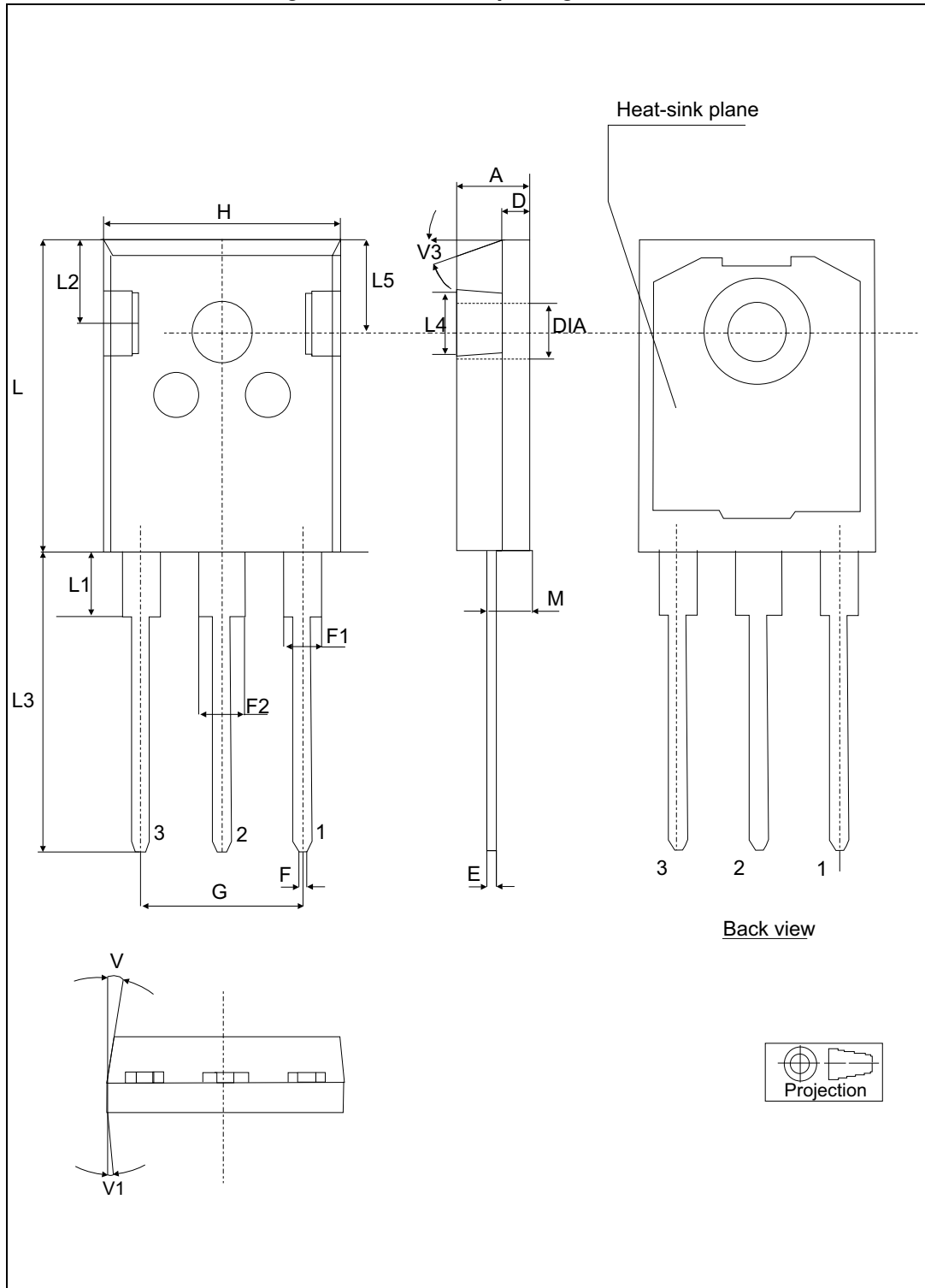

Table 8. TO-247 LL mechanical data

Ref.	Dimensions					
	Millimeters			Inches		
	Min.	Typ.	Max.	Min.	Typ	Max.
A	4.90		5.15	0.192		0.202
D	1.85		2.10	0.072		0.082
E	0.55		0.67	0.021		0.026
F	1.07		1.32	0.042		0.051
F1	1.90		2.38	0.074		0.093
F2	2.87		3.38	0.11		0.133
G	10.90 BSC			0.429 BSC		
H	15.77		16.02	0.62		0.63
L	20.82		21.07	0.81		0.82
L1	4.16		4.47	0.163		0.175
L2	5.49		5.74	0.216		0.225
L3	20.05		20.30	0.789		0.799
L4	3.68		3.93	0.144		0.154
L5	6.04		6.29	0.237		0.247
M	2.25		2.55	0.088		0.10
V		10°			10°	
V1		3°			3°	
V3		20°			20°	
∅	3.55		3.66	0.139		0.143

3 Ordering information

Table 9. Ordering information

Order code	Marking	Package	Weight	Base qty.	Delivery mode
STTH60AC06CP	STTH60AC06CP	TO3P-3L	5.26	30	Tube
STTH60AC06CPF	TH60AC06C	TO-3PF	5.6	30	Tube
STTH60AC06CW	STTH60AC06CW	TO-247 LL	4.36	30	Tube
STTH60AC06CWL	STTH60AC06CWL	TO-247 LL	4.36	30	Tube

4 Revision history

Table 10. Document revision history

Date	Revision	Changes
23-Jul-2013	1	First release.
20-Mar-2017	2	Added TO-247LL package information and reformatted to current standard.
29-Mar-2017	3	Updated Table 9 .

IMPORTANT NOTICE – PLEASE READ CAREFULLY

STMicroelectronics NV and its subsidiaries ("ST") reserve the right to make changes, corrections, enhancements, modifications, and improvements to ST products and/or to this document at any time without notice. Purchasers should obtain the latest relevant information on ST products before placing orders. ST products are sold pursuant to ST's terms and conditions of sale in place at the time of order acknowledgement.

Purchasers are solely responsible for the choice, selection, and use of ST products and ST assumes no liability for application assistance or the design of Purchasers' products.

No license, express or implied, to any intellectual property right is granted by ST herein.

Resale of ST products with provisions different from the information set forth herein shall void any warranty granted by ST for such product.

ST and the ST logo are trademarks of ST. All other product or service names are the property of their respective owners.

Information in this document supersedes and replaces information previously supplied in any prior versions of this document.

© 2017 STMicroelectronics – All rights reserved