

Evaluating the AD4134 24-Bit, 4-Channel, Simultaneous Sampling, 1.5 MSPS Precision Alias Free ADC

FEATURES

- ▶ Fully featured evaluation board for the [AD4134](#)
- ▶ PC control in conjunction with the [SDP-H1](#) board
- ▶ PC software control and data analysis
- ▶ Standalone hardware capability

EVALUATION KIT CONTENTS

- ▶ EVAL-AD4134FMCZ board
- ▶ AD4134

DOCUMENTS NEEDED

- ▶ AD4134 data sheet

EQUIPMENT NEEDED

- ▶ Evaluation kit
- ▶ SDP-H1 board
- ▶ DC or ac signal source (audio precision or a similar high performance signal source)
- ▶ PC running Windows® with a USB 2.0 port and the evaluation tool installed

SOFTWARE NEEDED

- ▶ AD4134 evaluation software (ACE)

EVAL-AD4134FMCZ PHOTOGRAPH

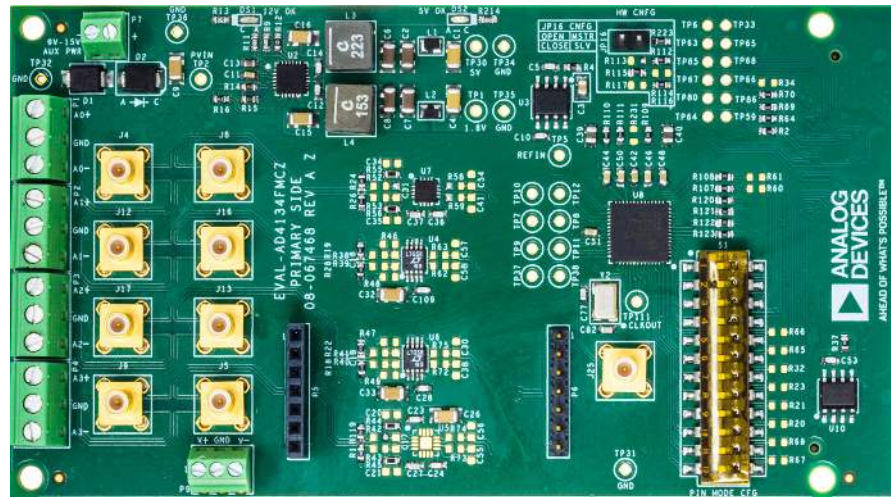

Figure 1.

GENERAL DESCRIPTION

The EVAL-AD4134FMCZ evaluation kit features the AD4134 24-bit, 4-channel, simultaneous sampling, 1.5 MSPS precision alias free analog-to-digital converter (ADC). The EVAL-AD4134FMCZ draws power from the system demonstration platform (SDP) [EVAL-SDP-CH1Z](#) (SDP-H1) board, and the on-board dc-to-dc regulators regulate an external supply of 8 V to 14 V down to 5 V and 1.8 V to supply the AD4134 and peripheral components. A separate reference of 4.096 V generated by the on-board [ADR444](#). The ADC is clocked by an on-board crystal.

The EVAL-AD4134FMCZ connects to the PC USB port via the SDP-H1 board.

The AD4134 evaluation software running on a PC provides full accessibility to the AD4134 device register map, as well as a data analysis interface to display key parameters and graphics from the conversion result in both time and frequency domains.

For full details on the AD4134, see the AD4134 data sheet, which must be consulted in conjunction with this user guide when using the EVAL-AD4134FMCZ.

Analog Devices is in the process of updating documentation to provide terminology and language that is culturally appropriate. This is a process with a wide scope and will be phased in as quickly as possible. Thank you for your patience.

TABLE OF CONTENTS

Features.....	1	Connectors and Sockets	6
Evaluation Kit Contents.....	1	Serial Data Interface.....	7
Documents Needed.....	1	Quad Channel Data Interface.....	7
Equipment Needed.....	1	Minimal Input/Output Configuration.....	7
Software Needed	1	Configuration Control Modes.....	8
General Description.....	1	Pin Control Mode.....	8
EVAL-AD4134FMCZ Photograph.....	1	SPI Control Mode.....	8
Evaluation Board Quick Start Procedure.....	3	Evaluation Board Software Quick Start	
Known Limitations and Issues.....	3	Procedures.....	9
Evaluation Board Hardware.....	4	Software Installation.....	9
Analog Inputs and Front-End Circuit.....	4	Launching the Software.....	10
Hardware Configuration Options.....	5	Notes.....	21

REVISION HISTORY**11/2021—Revision 0: Initial Version**

EVALUATION BOARD QUICK START PROCEDURE

The EVAL-AD4134FMCZ default configuration can be modified according to the evaluation requirement.

The [AD4134](#) evaluation software must be installed before setting up the EVAL-AD4134FMCZ. See the [Software Installation](#) section for more details.

To set up the EVAL-AD4134FMCZ, take the following steps:

1. Ensure that the [SDP-H1](#) board is powered off and disconnected from the USB port of the PC, and then download and install the [Analysis, Control, Evaluation \(ACE\)](#) evaluation software.
2. When the ACE evaluation software installation is complete, restart the PC. See the [Software Installation](#) section for more details on the ACE evaluation software installation.
3. Connect the J4 connector of the SDP-H1 board to the P8 connector of the powered down EVAL-AD4134FMCZ, as shown in [Figure 2](#). Ensure that the boards are connected firmly together and all S1 switch positions are off.
4. Connect the 12 V dc adapter to the SDP-H1 board. The EVAL-AD4134FMCZ draws power from the SDP-H1 board and does not require any separate power connection.
5. Connect the SDP-H1 board to the PC using the USB cable provided with the SDP-H1 board. The PC can search for the SDP-H1 board drivers automatically. If prompted by the operat-

ing system, choose to automatically search for the drivers for the SDP-H1 board.

6. Launch the ACE software from the shortcut on the desktop and select the **AD4134 Eval Board** icon in the **Attached Hardware** section.

KNOWN LIMITATIONS AND ISSUES

The known limitations and issues for the EVAL-AD4134FMCZ include the following:

- ▶ GPIO functionality cannot be exercised in SPI mode. The DCLKRATE1/GPIO1, DCLKRATE2/GPIO2, PWRMODE/ GPIO3, FILTER0/GPIO4, FILTER1/GPIO5, FRAME0/ GPIO6, and FRAME1/GPIO7 pins are only used for pin control mode configuration usage.
- ▶ The [ACE](#) evaluation software does not support free running DCLK mode, minimal input/output mode, daisy-chaining mode, 16-bit data mode, 16-bit data with cyclic redundancy check (CRC), or 24-bit data with CRC.
- ▶ The ACE evaluation software supports only a fixed DCLK frequency value of 48 MHz.
- ▶ The ACE evaluation software supports only ODR up to 1.2 MHz in master mode and 1.449 MHz in slave mode.

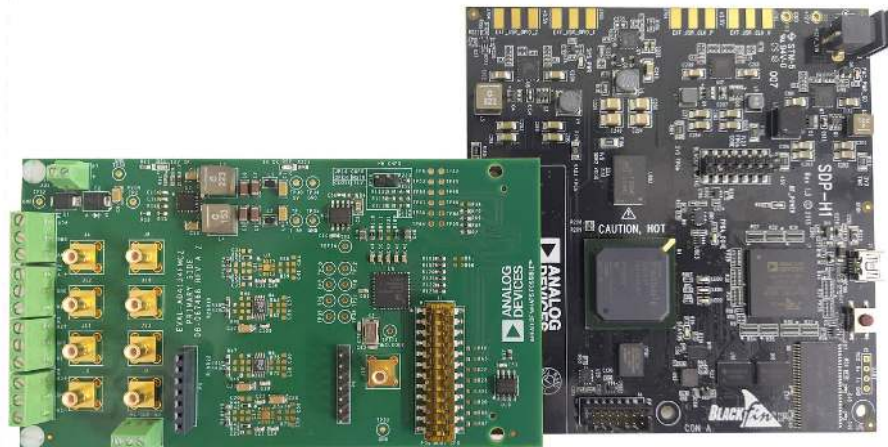

Figure 2. EVAL-AD4134FMCZ and SDP-H1 Board Connection

EVALUATION BOARD HARDWARE

ANALOG INPUTS AND FRONT-END CIRCUIT

The EVAL-AD4134FMCZ supports four input channels that can be fed via either the Subminiature Version B (SMB) connectors or the terminal blocks. The input signal can be fed either directly via the front end, or directly to the AD4134 by using the resistor link options shown in Table 1. Additionally, the Channel 3 signal can be fed via an amplifier mezzanine card (AMC).

The amplifier inputs do not terminate for any particular source impedance. The on-board, common-mode voltage (V_{CM}) source on the AD4134 biases the input signal. The default condition is $V_{CM} = V_{REF}/2$, where V_{REF} is the reference voltage.

Another option available for the front-end circuit is using an AMC, which is available for Channel 3 using the P5 and P6 connectors.

Table 1. Input Connection Options

Channel No.	Input via	Mounted	Not Mounted
0	Direct (default)	R24, R26	R52, R53, R58, R59
	Front end	R52, R53, R58, R59	R24, R26
1	Direct (default)	R19, R28	R38, R39, R62, R63
	Front end	R38, R39, R62, R63	R19, R28
2	Direct (default)	R18, R22	R40, R41, R72, R75
	Front end	R40, R41, R72, R75	R18, R22
3	Direct (default)	R1, R119	R42, R43, R73, R74
	Front end	R42, R43, R73, R74	R1, R119
	AMC	R1, R119, R42, R43, R73, R74	R1, R119, R42, R43, R73, R74

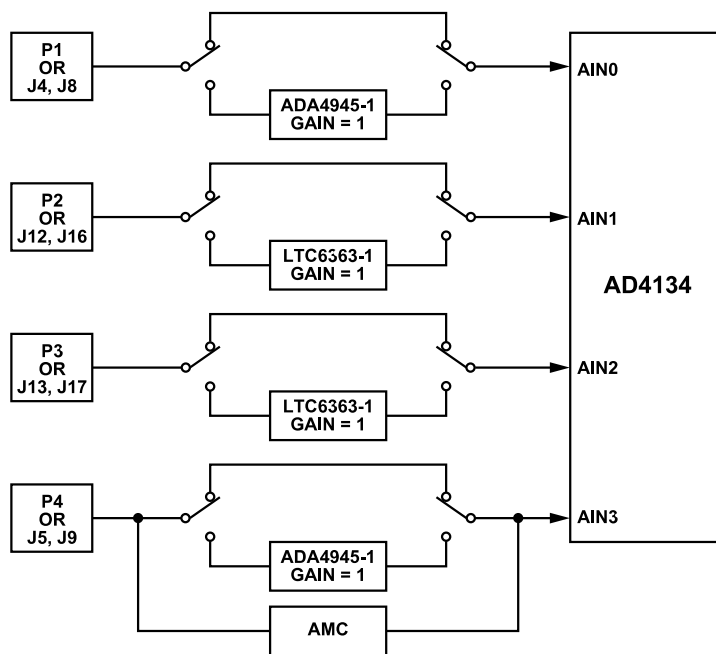

Figure 3. Analog Front-End Block

003

EVALUATION BOARD HARDWARE

HARDWARE CONFIGURATION OPTIONS

Device Power Supply

The AD4134 can be powered with external supplies, or the integrated low dropout (LDO) regulators can generate the 1.8 V rails to supply the AVDD1V8, DVDD1V8, and CLKVDD supplies.

See [Table 2](#) for setting the desired power rail option. The IOVDD pin supplies the interface logic and is powered up by the SDP-H1 board via the field-programmable gate array (FPGA) mezzanine card (FMC) connector.

Front-End Circuit Power Supply

The analog front end of all the channels is powered using the 5 V supply. Additionally, Channel 3 can be powered using an external supply connected via the P9 external connector.

Table 2. Power Rail Options

Power Rail	Link	Internal LDO Regulator	External Supply (Default)
1V8CLKVDD	R88	Not connected	Mounted
1V8DVDD	R89	Not connected	Mounted
1V8AVDD	R90	Not connected	Mounted
LDOIN	R109, R231	Mount R231, remove R109	Remove R231, Mount R109

Table 3. Channel 3 Front-End Circuit Power Options

Power Rail	Source (V)	Mounted	Not Mounted	Default
V+	5	R71		Yes
	+EXT_PWR		R71	No
V-	0	R57		Yes
	-EXT_PWR		R57	No

Table 4. LED Functions

LED	Description
DS1	Input Power Indication LED. When illuminated, this LED indicates that power is present on the EVAL-AD4134FMCZ.
DS2	5 V Supply Indication LED. When illuminated, this LED indicates a 5 V power supply to ADCs.

When using an external supply via the P9 external connector, ensure that R3 and R57 are not connected.

Clock

The AD4134 is clocked using the integrated oscillator with an external crystal. Alternatively, the CMOS clock can be fed using J25.

Reference

The AD4134 has a 4.096 V reference supply generated by the ADR444, which is a low noise reference.

LED

Status indicator LEDs display the state of the EVAL-AD4134FMCZ when illuminated, as described in [Table 4](#).

EVALUATION BOARD HARDWARE

CONNECTORS AND SOCKETS

The inputs and outputs can connect to the EVAL-AD4134FMCZ using the major connectors and sockets shown in [Table 5](#).

Table 5. Connectors and Sockets

Connector	Function	Connector Type
J25	SMB connector for XTAL2 external clock input	Straight printed circuit board (PCB) mount SMB jack
J4, J8, J12, J16, J13, J17, J5, J9	Analog input SMB terminals for Channel 0 to Channel 3	Straight PCB mount SMB jacks
P1 to P4	3-pin connectors for the four differential analog inputs	Fixed terminal blocks, 8-pin, 3.81 mm, 90°
P7	Optional benchtop power supply voltage input	Fixed terminal blocks, 2-pin 2.54 mm, 90°
P9	Optional benchtop power supply front-end voltage for Channel 3	Fixed terminal blocks, 3-pin, 2.54 mm, 90°
P5, P9	Optional external connectors, AMC daughter card, Channel 3	7-way, 2.54 mm vertical sockets
P8	Connection to SDP-H1 board	160-pin, 10 mm, male, VITA 57 connector

SERIAL DATA INTERFACE

QUAD CHANNEL DATA INTERFACE

The EVAL-AD4134FMCZ has four simultaneous sampling ADC channels. The conversion output data is sent to the [SDP-H1](#) board using six interface lines that consist of four data lines, a clock signal (DCLK), and a frame control signal (controlled by ODR). [Table 6](#) lists the two mode connections.

Table 6. Device Mode Options

ASRC Mode	Mode
Master Mode with DCLK Output	ODR and DCLK are generated by the AD4134. JP16 is open.
Slave Mode with DCLK Input	ODR and DCLK are generated by the digital host. JP16 is closed.

MINIMAL INPUT/OUTPUT CONFIGURATION

To set the device in minimal input/output mode, configure the device in slave mode and use the R60 and R61 links.

CONFIGURATION CONTROL MODES

The AD4134 can be controlled either by configuring the pins or via the serial port interface (SPI), which is controlled using the $\overline{\text{PIN}}/\text{SPI}$ pin. The AD4134 is set either to SPI control mode or to pin control mode. Mandatory pins to be configured in both the control modes are $\overline{\text{PIN}}/\text{SPI}$, DEC0/DCLKIO, CLKSEL, MODE, and DEC1/DCLKMODE. See Table 7 for the possible jumper configurations for these modes. Use 10 k Ω resistors for the jumper links to set a specific pin.

PIN CONTROL MODE

Mounting R113 and removing R112 sets the AD4134 in pin control mode. Use the hardware pins shown in Table 7 and Table 8 to set

the device configuration and run the AD4134 in standalone mode. Use 10 k Ω resistors to set a pin. The S1 switch controls the pin control mode options.

SPI CONTROL MODE

The R112 resistor mounted with 10 k Ω enables SPI control mode. R113 is not connected. Use the SPI registers to set up the device for the desired configuration. The 4-wire or 3-wire SPI can be used to configure the device for all configurations except the $\overline{\text{PIN}}/\text{SPI}$, DEC0/DCLKIO, CLKSEL, MODE, and DEC1/DCLKMODE pins. Ensure all S1 switch positions are off.

Table 7. Mandatory Jumper and Resistor Configurations for Pin Control Mode and SPI Control Mode

Pin Name	Jumper/Resistor	High	Low	Default
$\overline{\text{PIN}}/\text{SPI}$	R112	Mounted	Not connected	Yes
	R113	Not connected	Mounted	No
DEC1/DCLKMODE	R114	Mounted	Not connected	No
	R115	Not connected	Mounted	Yes
MODE and DEC0/DCLKIO	JP16	Open	Closed	High
CLKSEL	R116	Mounted	Not connected	Yes
	R117	Not connected	Mounted	No

Table 8. Pin Control Mode Configurations

Pin Name	S1 Switch	Pulled High (Default)	Pulled Low
DEC2/SDI	1	Open	Close
DEC3/SDO	2	Open	Close
FORMAT1/SCLK	3	Open	Close
FORMAT0/ $\overline{\text{CS}}$	4	Open	Close
FRAME1/GPIO7	5	Open	Close
FRAME0/GPIO6	6	Open	Close
FILTER1/GPIO5	7	Open	Close
FILTER0/GPIO4	8	Open	Close
PWRMODE/GPIO3	9	Open	Close
DCLKRATE2/GPIO2	10	Open	Close
DCLKRATE1/GPIO1	11	Open	Close
DCLKRATE0/GPIO0	12	Open	Close

EVALUATION BOARD SOFTWARE QUICK START PROCEDURES

SOFTWARE INSTALLATION

The EVAL-AD4134FMCZ can be analyzed in the ACE evaluation software from Analog Devices, Inc.

Download the ACE evaluation software from the ACE software page or from the AD4134 product page. Download and install ACE on a PC before using the EVAL-AD4134FMCZ.

Ensure that the SDP-H1 board is not connected to the PC during the ACE installation process.

The software installation process includes the following:

- ▶ ACE evaluation software installation
- ▶ SDP-H1 driver installation

Install the ACE evaluation software and SDP-H1 drivers before connecting the EVAL-AD4134FMCZ and SDP-H1 to the USB port of the PC to ensure that the evaluation system is properly recognized when it is connected to the PC.

Installing the ACE Evaluation Software

To install the ACE evaluation software, take the following steps:

1. Download the ACE evaluation software to a Windows-based PC.
2. Double-click the ACEInstall.exe file to begin the installation. By default, the software is saved to the following location: **C:\Program Files (x86)\Analog Devices\ACE.**
3. A dialog box opens asking for permission to allow the program to make changes to the PC. Click **Yes** to begin the installation process.
4. In the **ACE Setup** window, click **Next >** to continue the Installation (see Figure 4).



Figure 4. Evaluation Software Installation—Install Confirmation

5. Read the software license agreement and click **I Agree** (see Figure 5).



Figure 5. Evaluation Software Installation—License Agreement

6. Click **Browse...** to choose the install location and then click **Next >** (see Figure 6).

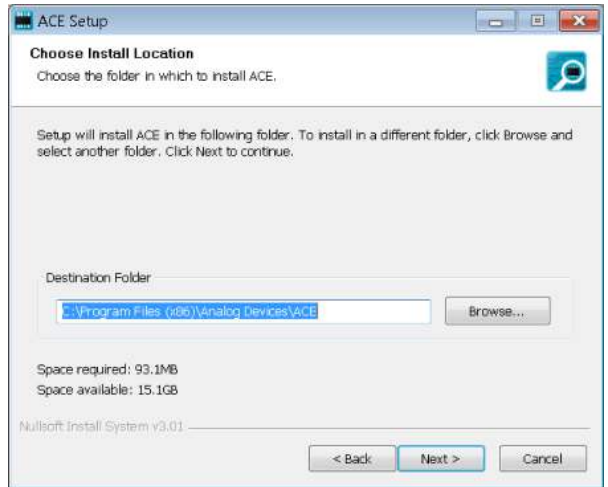

Figure 6. Evaluation Software Installation—Install Location

7. The ACE software components to install are preselected (see Figure 7). Click **Install**.

EVALUATION BOARD SOFTWARE QUICK START PROCEDURES

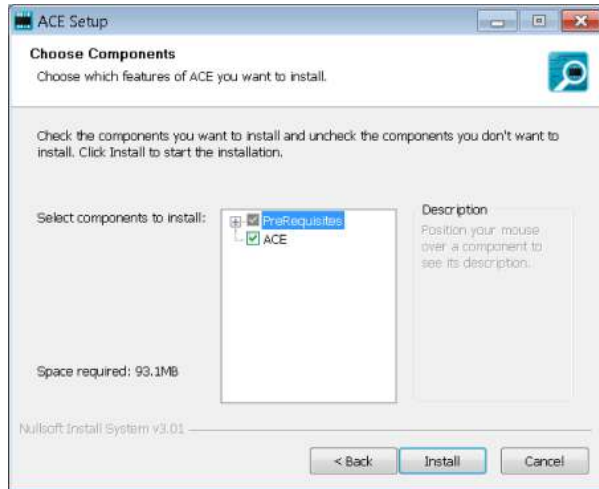

Figure 7. Evaluation Software Installation—Install Components

- The **Windows Security** window opens (see Figure 8). Click **Install**. Figure 9 shows the installation in progress. No action is required.



Figure 8. Evaluation Software Installation—Windows Security

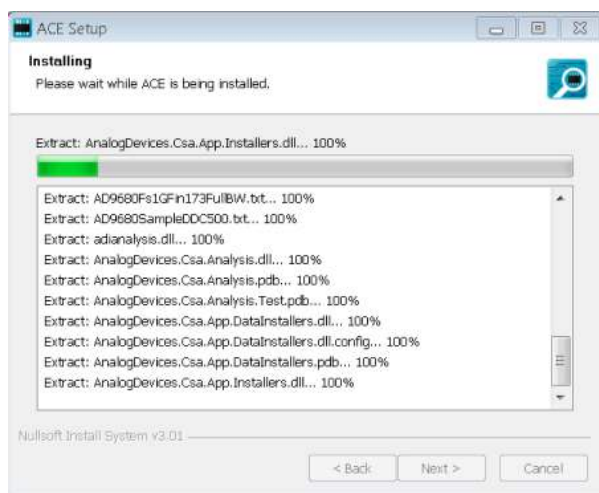

Figure 9. Evaluation Software Installation—Installation in Progress

- When the installation is complete, click **Next >** (see Figure 10) and then click **Finish** to complete the installation process.

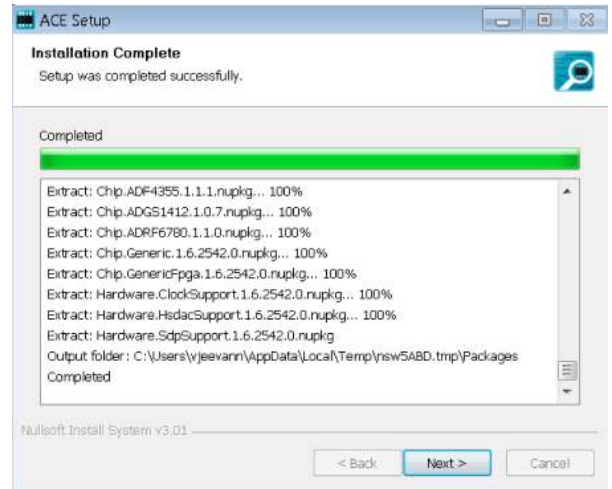

Figure 10. SDP-H1 Drivers Installation—Completing the Installation

LAUNCHING THE SOFTWARE

After the EVAL-AD4134FMCZ and SDP-H1 are properly connected to the PC, launch the ACE evaluation software by taking the following steps:

- From the **Start** menu of the PC, select **All Programs > Analog Devices > ACE > ACE.exe** to open the ACE software main window (see Figure 11).
- If the EVAL-AD4134FMCZ is not connected to the USB port via the SDP-H1 when the software launches, the **AD4134 Eval Board** icon does not appear in the **Attached Hardware** section in ACE (see Figure 11). To make the **AD4134 Eval Board** icon appear, connect the EVAL-AD4134FMCZ and the SDP-H1 to the USB port of the PC, wait a few seconds, and then follow the instructions in the dialog box that opens.
- Double click the **AD4134 Eval Board** icon in **Attached Hardware** section to open the **AD4134 Eval Board** view window shown in Figure 12.
- Double click on the **AD4134** chip icon in the **AD4134 Eval Board** view window to open the **AD4134** chip view window shown in Figure 13.

EVALUATION BOARD SOFTWARE QUICK START PROCEDURES

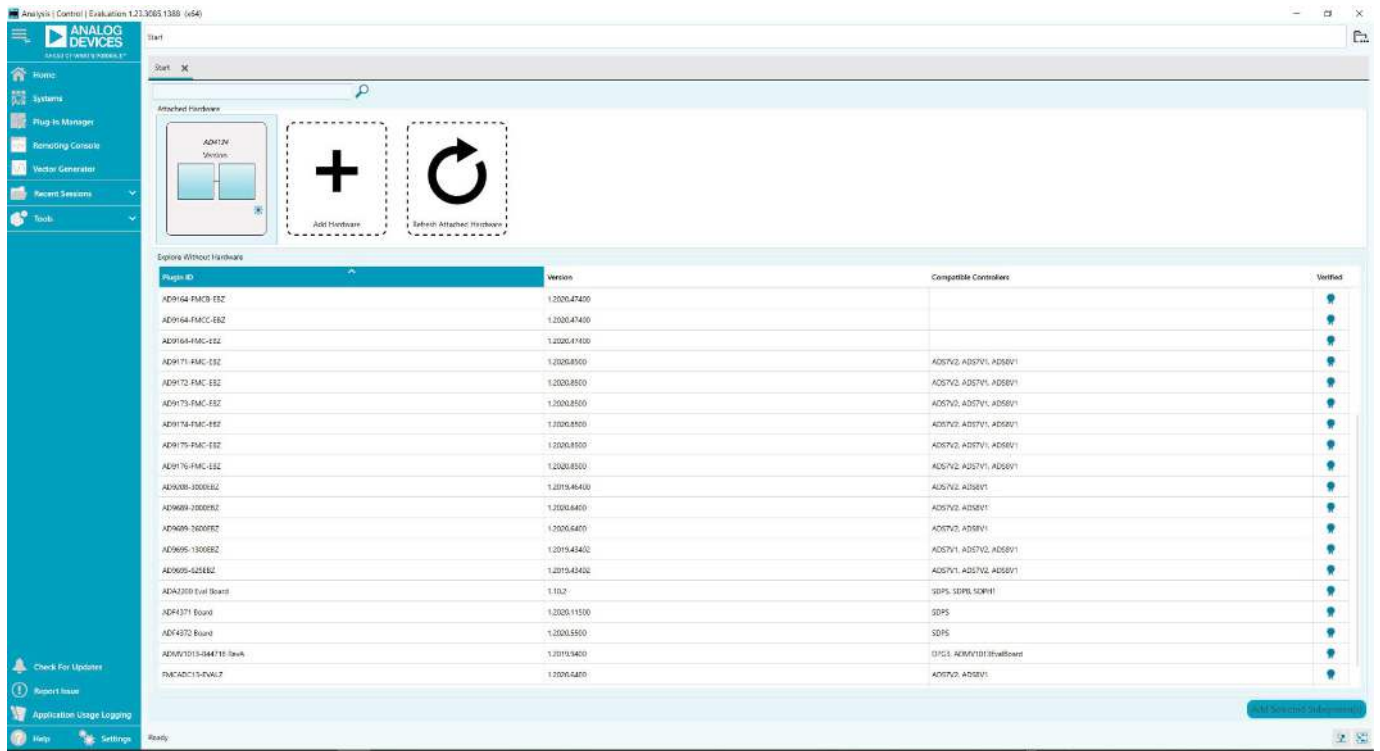

Figure 11. ACE Software Main Window

EVALUATION BOARD SOFTWARE QUICK START PROCEDURES

Description of Board View

The AD4134 Eval Board view window shows the set configuration of the AD4134 (see Figure 12). The application initializes the ADCs

and loads the register map for a default configuration. This process takes a few seconds to complete.

EVAL-AD4134FMCZ

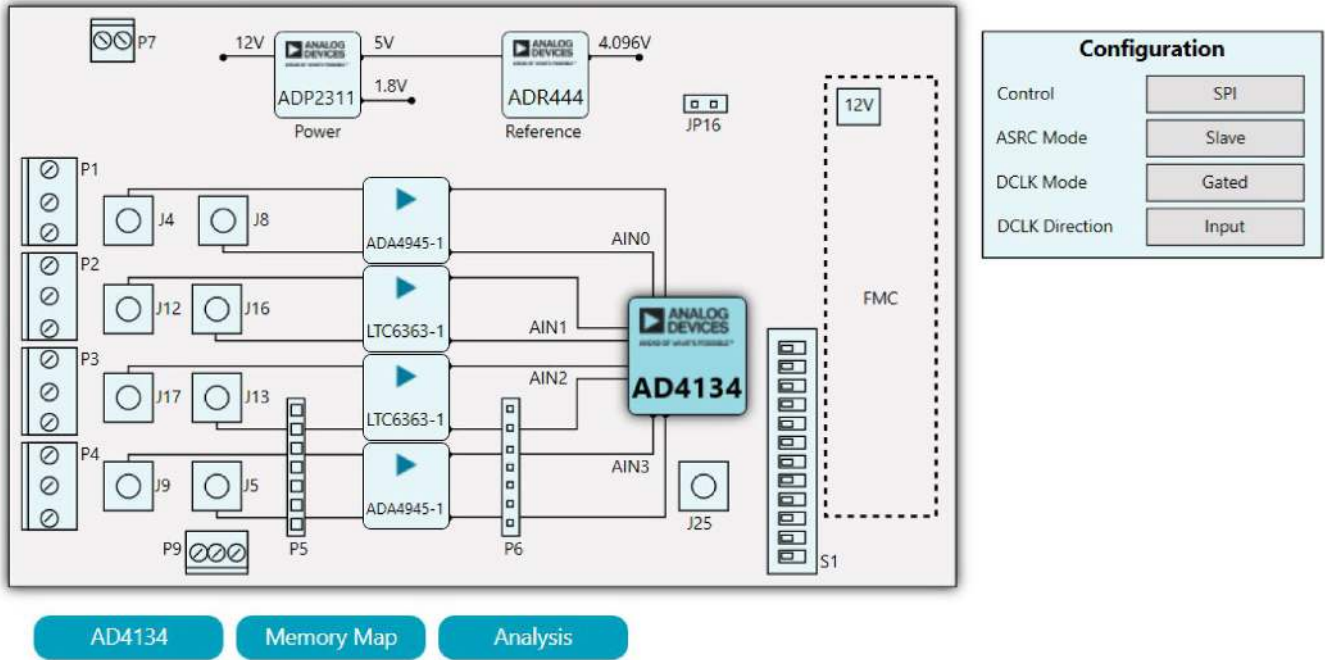

Figure 12. AD4134 Eval Board View Window

EVALUATION BOARD SOFTWARE QUICK START PROCEDURES

Description of Chip View

After completing the steps in the [Software Installation](#) section, set up the system for data capture.

The **AD4134** chip view window shows the programmable blocks (see [Figure 13](#)). Dark blue block icons are programmable blocks.

Clicking a dark blue block icon opens a configurable pop-up window that allows customization for the data capture (see [Figure 14](#)). Click **Proceed to Memory Map** to view or edit the registers or bit fields.

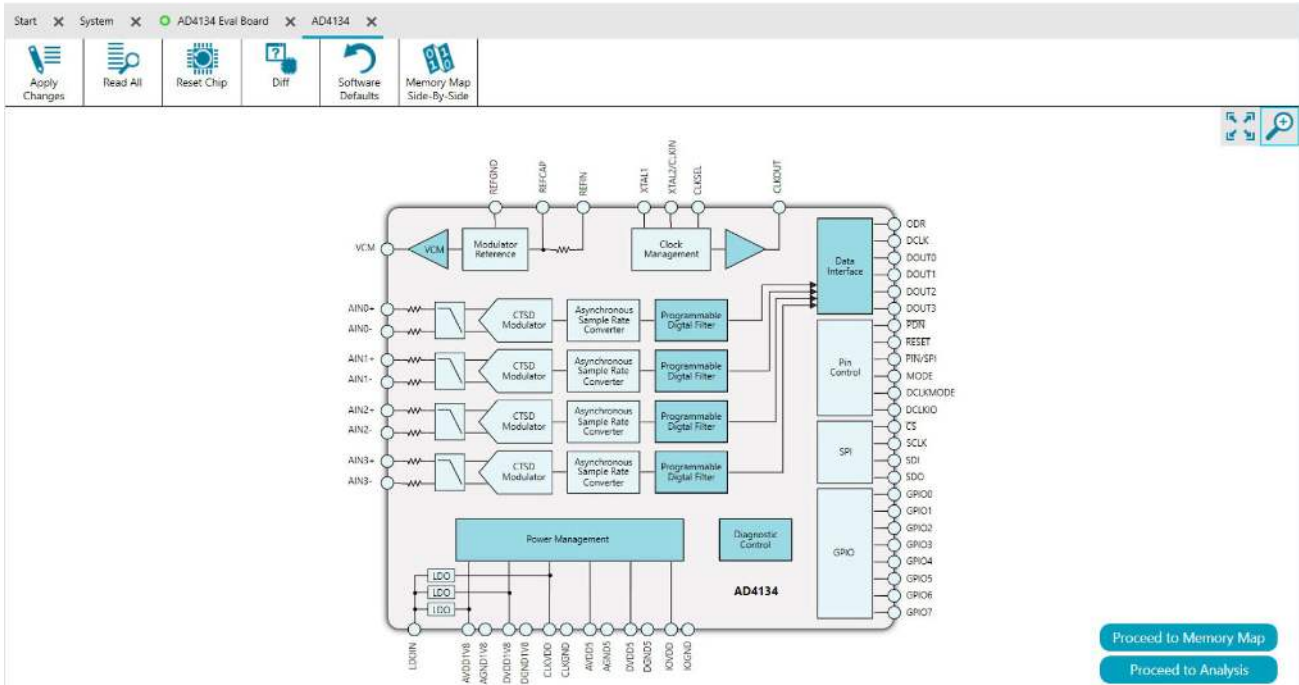

Figure 13. AD4134 Chip View Window

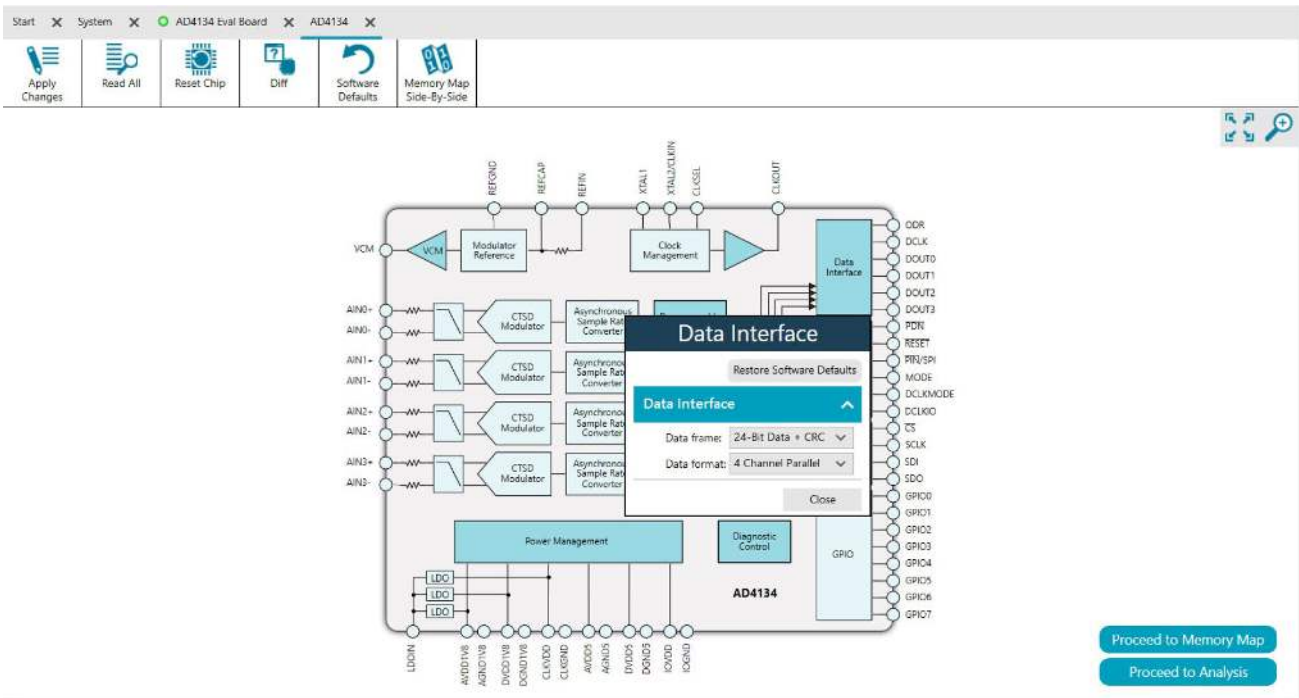

Figure 14. Pop-Up Configurable Window

EVALUATION BOARD SOFTWARE QUICK START PROCEDURES

Memory Map

Memory Map for the specific functions of the buttons in the AD4134 Memory Map view window.

Click **Proceed to Memory Map** in the **AD4134** chip view window to open the **AD4134 Memory Map** window (see [Figure 15](#)). See

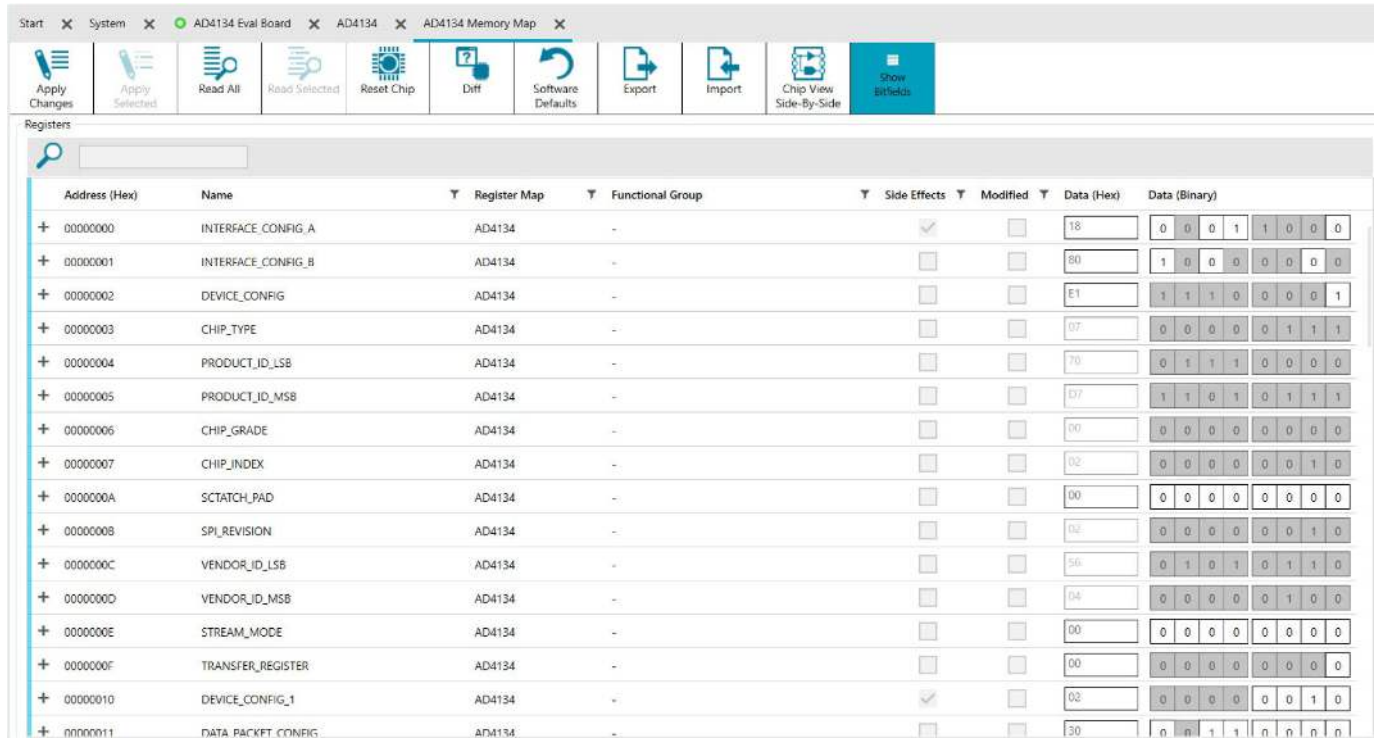

Figure 15. AD4134 Memory Map View Window

Table 9. Memory Map Buttons

Button	Description
Apply Changes	Writes the values changed in all of the registers. The edited registers are bold before the user clicks Apply Changes .
Apply Selected	Writes to the selected register from the chip.
Read All	Reads the values of all the registers from the chip.
Read Selected	Reads the selected register from the chip.
Reset Chip	Prompts the software to reset the chip.
Diff	Checks for differences in register values between the software and the chip. The registers with differences are in bold.
Software Defaults	Changes the register values to the software defaults.

EVALUATION BOARD SOFTWARE QUICK START PROCEDURES

Analysis View

Click **Proceed to Analysis** in the chip view window or **Proceed to Data Capture** in the **AD4134 Eval Board** view window to open the **AD4134 Analysis** view window (see [Figure 16](#)). The **AD4134**

Analysis view window contains the **Waveform** tab, **Histogram** tab, and **FFT** tab. Each tab has three panes: the **CAPTURE** pane, **ANALYSIS** pane, and **RESULTS** pane.

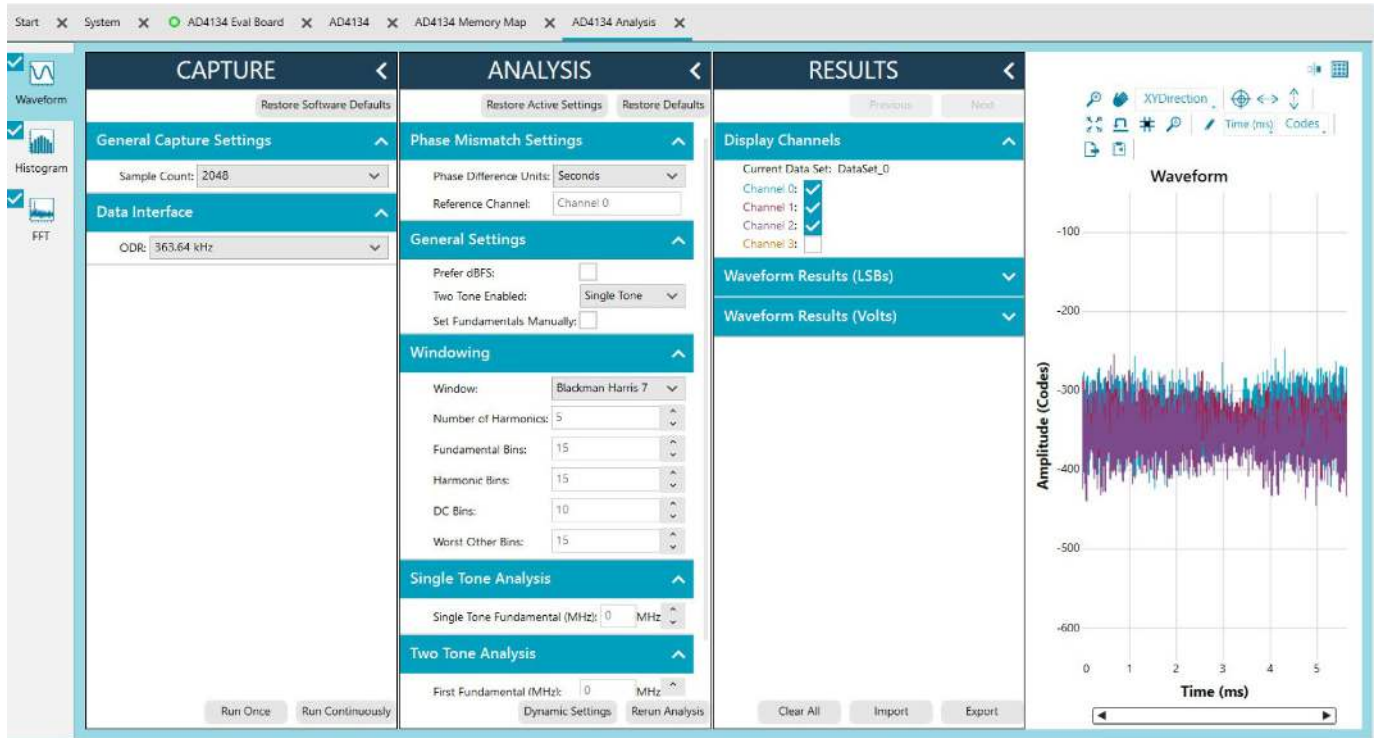

Figure 16. AD4134 Analysis View Window

EVALUATION BOARD SOFTWARE QUICK START PROCEDURES

CAPTURE

The **CAPTURE** pane contains the capture settings. These settings reflect onto the registers automatically before data capture. See [Table 10](#) for the general capture settings.

Table 10. General Capture Settings

Setting	Description
ODR (Hz)	This option is available only if one of the AD4134 devices is in Master mode . Enter the desired ODR to change the ODR.
ODR Select (Hz)	This option is available only if both of the AD4134 devices are in Slave mode . Select the desired ODR from the dropdown menu.
Sample Count	This open selects the number of samples per channel, per capture. Click Run Once to start a data capture of the samples at the sample rate specified in the Sample Count field. These samples are stored on the SDP-H1 and are only transferred to the PC when the sample frame is complete. Click Run Continuously to start a data capture that gathers samples continuously with one batch of data at a time.

EVALUATION BOARD SOFTWARE QUICK START PROCEDURES

RESULTS

The **Display Channels** section allows the user to select which channels to capture. The channel data is shown only if that channel is selected before the capture.

The **General Capture Parameters** section displays the date and time of the capture.

The **Waveform Results** section displays average, peak-to-peak voltage and other parameters of the signal in the **Waveform** tab.

The **Signal** section displays the **Sample Frequency**, **Sample Count**, **Fund Frequency**, and **Fund Power**.

The **Noise** section displays the SNR and other noise performance results in the **FFT** tab.

The **Distortion** section displays the harmonic content of the sampled signal and dc power when viewing the FFT analysis in the **FFT** tab.

Click **Export** to export captured data. The waveform, histogram, and FFT data are stored in .xml files along with the values of parameters at capture.

The data **Waveform** graph (see [Waveform Tab](#)) shows each successive sample of the ADC output. Zoom in and out and pan over the **Waveform** graph using the embedded waveform tools above the graph. Select the channels to display in the **Display Channels** section.

Under the **Display Units** dropdown menu (see [Waveform Tab](#)), select **Codes** above the **Waveform** graph to select whether the data graph displays in units of **Codes**, **Hex**, or **Volts**. The axis controls are dynamic. Note that the corresponding axis width automatically adjusts to show the entire range of the ADC results after each batch of samples when either **y-scale dynamic** or **x-scale dynamic** is selected.

Histogram Tab

The **Histogram** tab contains the histogram graph and the **RESULTS** pane (see [Figure 17](#)). Click **RESULTS** to display the information related to the dc performance.

The **Histogram** graph displays the number of hits per code within the sampled data. This graph displays dc analysis and indicates the noise performance of the device.

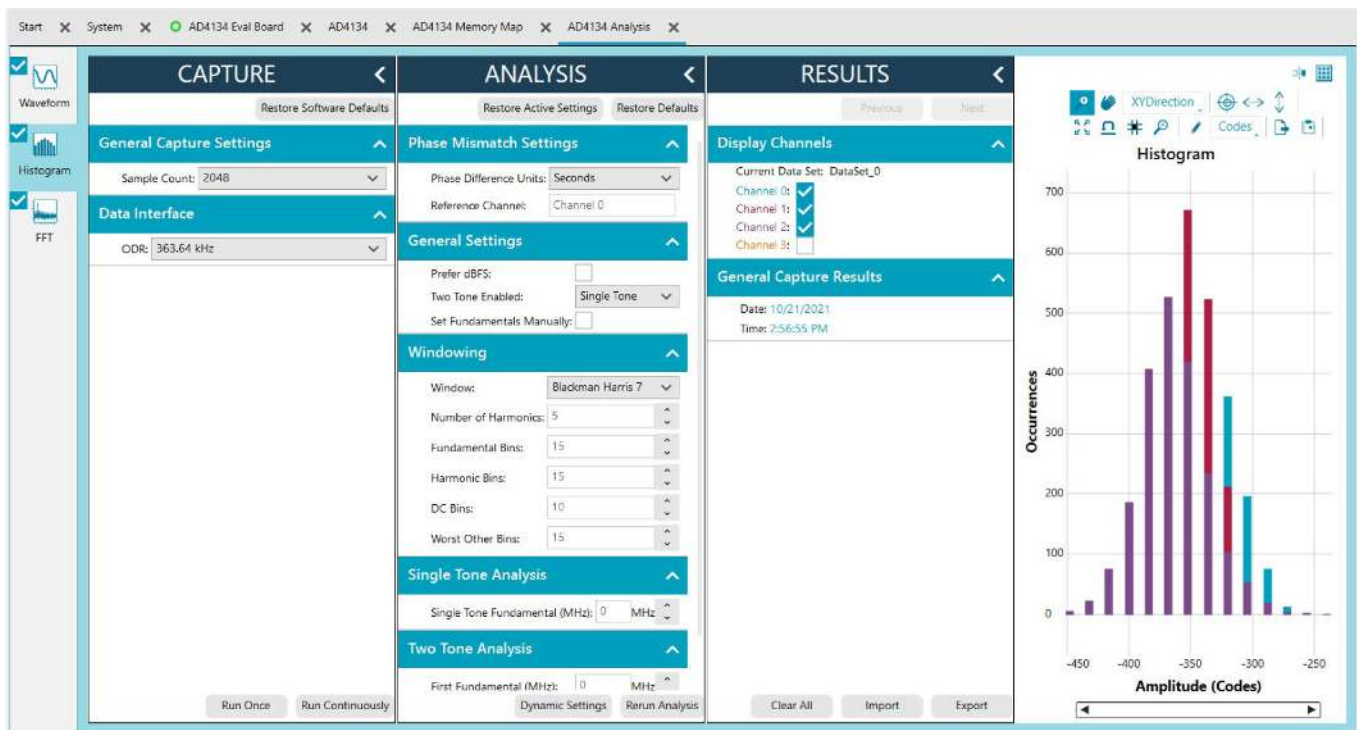

Figure 17. Histogram Tab

EVALUATION BOARD SOFTWARE QUICK START PROCEDURES

Waveform Tab

The **Waveform** tab displays data in the form of time vs. discrete data values with the results (see [Figure 18](#)). The **CAPTURE** pane

contains the capture settings, which reflect onto the registers automatically before data capture.

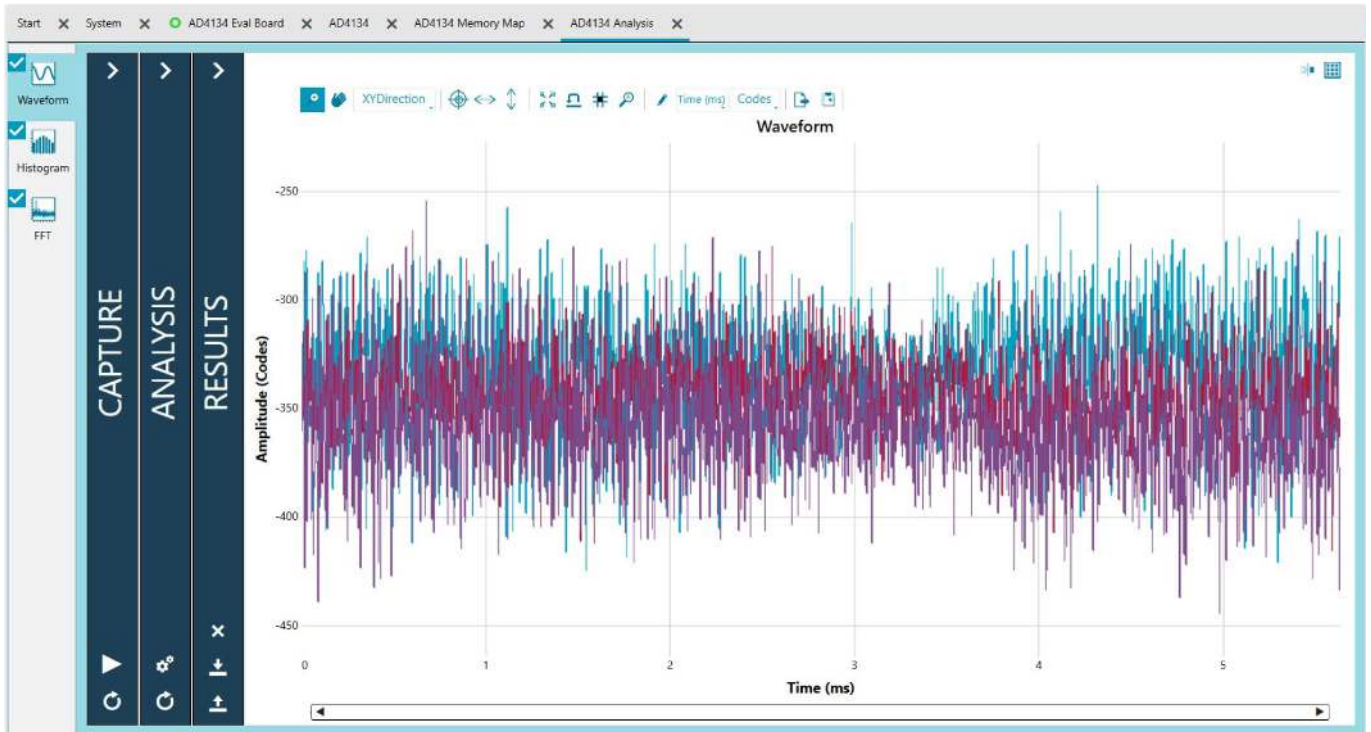

Figure 18. Waveform Tab

018

EVALUATION BOARD SOFTWARE QUICK START PROCEDURES

FFT Tab

ACE includes the ability for plugins to use a full featured fast Fourier transform (FFT) analyzer. The user can change the analysis parameters, such as windowing and harmonics, and rerun the analysis for the same capture.

Figure 19 shows the FFT tab. This tab displays FFT information for the last batch of samples gathered.

The **General Settings** section allows the user to set up the preferred configuration of the FFT analysis. The fundamental is set manually.

The **Windowing** section allows the user to select the windowing type used in the FFT analysis, the number of **Harmonic Bins**, and the number of **Fundamental Bins** that must be included.

The **Single Tone Analysis** and **Two Tone Analysis** sections allow the user to select the fundamental frequency included in the FFT analysis. Use the **Two Tone Analysis** settings when analyzing two frequencies.

For more information, visit the [FFT analysis features wiki page](#).

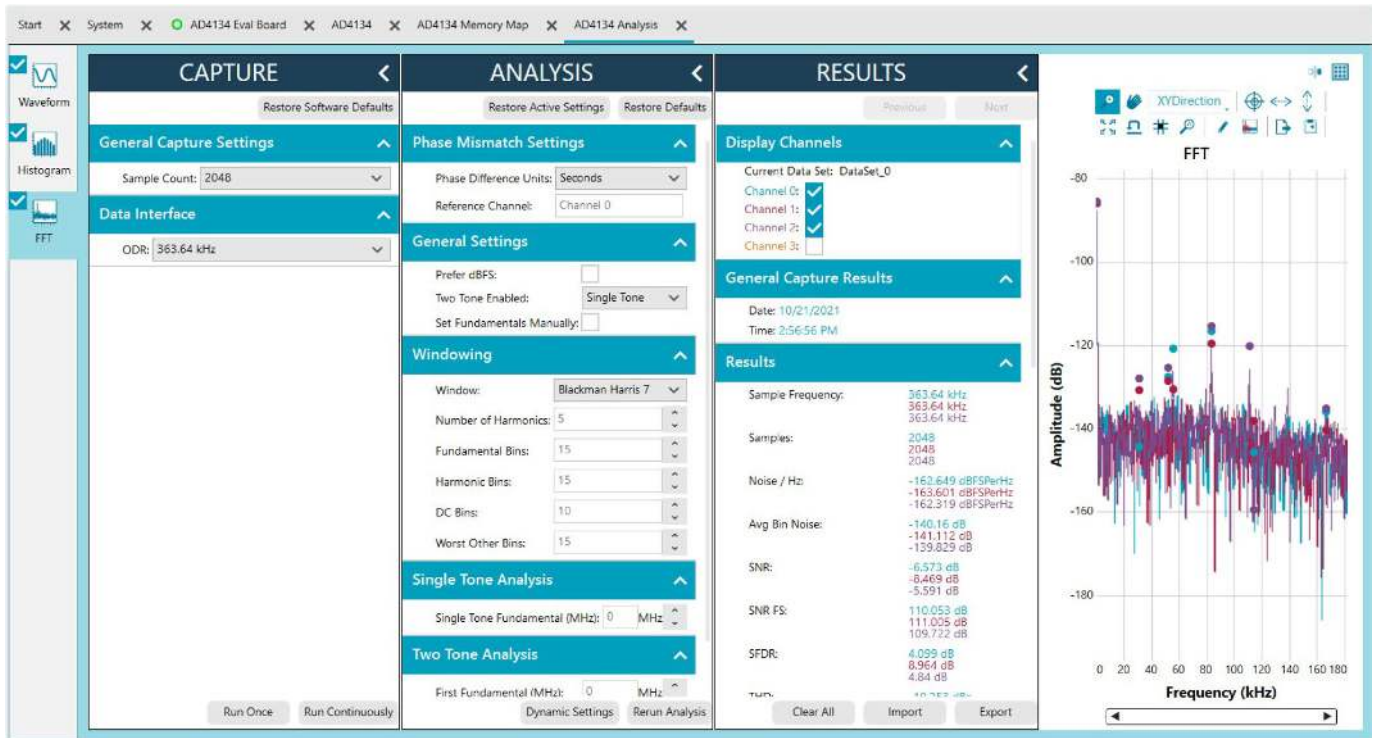

Figure 19. FFT Tab

EVALUATION BOARD SOFTWARE QUICK START PROCEDURES

Exiting the Software

To exit the software, click **File** and then click **Exit**.

NOTES**ESD Caution**

ESD (electrostatic discharge) sensitive device. Charged devices and circuit boards can discharge without detection. Although this product features patented or proprietary protection circuitry, damage may occur on devices subjected to high energy ESD. Therefore, proper ESD precautions should be taken to avoid performance degradation or loss of functionality.

Legal Terms and Conditions

By using the evaluation board discussed herein (together with any tools, components documentation or support materials, the "Evaluation Board"), you are agreeing to be bound by the terms and conditions set forth below ("Agreement") unless you have purchased the Evaluation Board, in which case the Analog Devices Standard Terms and Conditions of Sale shall govern. Do not use the Evaluation Board until you have read and agreed to the Agreement. Your use of the Evaluation Board shall signify your acceptance of the Agreement. This Agreement is made by and between you ("Customer") and Analog Devices, Inc. ("ADI"), with its principal place of business at Subject to the terms and conditions of the Agreement, ADI hereby grants to Customer a free, limited, personal, temporary, non-exclusive, non-sublicensable, non-transferable license to use the Evaluation Board FOR EVALUATION PURPOSES ONLY. Customer understands and agrees that the Evaluation Board is provided for the sole and exclusive purpose referenced above, and agrees not to use the Evaluation Board for any other purpose. Furthermore, the license granted is expressly made subject to the following additional limitations: Customer shall not (i) rent, lease, display, sell, transfer, assign, sublicense, or distribute the Evaluation Board; and (ii) permit any Third Party to access the Evaluation Board. As used herein, the term "Third Party" includes any entity other than ADI, Customer, their employees, affiliates and in-house consultants. The Evaluation Board is NOT sold to Customer; all rights not expressly granted herein, including ownership of the Evaluation Board, are reserved by ADI. CONFIDENTIALITY. This Agreement and the Evaluation Board shall all be considered the confidential and proprietary information of ADI. Customer may not disclose or transfer any portion of the Evaluation Board to any other party for any reason. Upon discontinuation of use of the Evaluation Board or termination of this Agreement, Customer agrees to promptly return the Evaluation Board to ADI. ADDITIONAL RESTRICTIONS. Customer may not disassemble, decompile or reverse engineer chips on the Evaluation Board. Customer shall inform ADI of any occurred damages or any modifications or alterations it makes to the Evaluation Board, including but not limited to soldering or any other activity that affects the material content of the Evaluation Board. Modifications to the Evaluation Board must comply with applicable law, including but not limited to the RoHS Directive. TERMINATION. ADI may terminate this Agreement at any time upon giving written notice to Customer. Customer agrees to return to ADI the Evaluation Board at that time. LIMITATION OF LIABILITY. THE EVALUATION BOARD PROVIDED HEREUNDER IS PROVIDED "AS IS" AND ADI MAKES NO WARRANTIES OR REPRESENTATIONS OF ANY KIND WITH RESPECT TO IT. ADI SPECIFICALLY DISCLAIMS ANY REPRESENTATIONS, ENDORSEMENTS, GUARANTEES, OR WARRANTIES, EXPRESS OR IMPLIED, RELATED TO THE EVALUATION BOARD INCLUDING, BUT NOT LIMITED TO, THE IMPLIED WARRANTY OF MERCHANTABILITY, TITLE, FITNESS FOR A PARTICULAR PURPOSE OR NON-INFRINGEMENT OF INTELLECTUAL PROPERTY RIGHTS. IN NO EVENT WILL ADI AND ITS LICENSORS BE LIABLE FOR ANY INCIDENTAL, SPECIAL, INDIRECT, OR CONSEQUENTIAL DAMAGES RESULTING FROM CUSTOMER'S POSSESSION OR USE OF THE EVALUATION BOARD, INCLUDING BUT NOT LIMITED TO LOST PROFITS, DELAY COSTS, LABOR COSTS OR LOSS OF GOODWILL. ADI'S TOTAL LIABILITY FROM ANY AND ALL CAUSES SHALL BE LIMITED TO THE AMOUNT OF ONE HUNDRED US DOLLARS (\$100.00). EXPORT. Customer agrees that it will not directly or indirectly export the Evaluation Board to another country, and that it will comply with all applicable United States federal laws and regulations relating to exports. GOVERNING LAW. This Agreement shall be governed by and construed in accordance with the substantive laws of the Commonwealth of Massachusetts (excluding conflict of law rules). Any legal action regarding this Agreement will be heard in the state or federal courts having jurisdiction in Suffolk County, Massachusetts, and Customer hereby submits to the personal jurisdiction and venue of such courts. The United Nations Convention on Contracts for the International Sale of Goods shall not apply to this Agreement and is expressly disclaimed.

