

# Eurostyle Terminal Blocks Focus Product Stock List

## Introduction

In an ongoing effort to better serve the Industrial Machinery, Commercial, and HVAC markets, Tyco Electronics is pleased to present the creation of the “Eurostyle Terminal Blocks Focus Products List”.

This Focus Products list is comprised of product lines which are regularly stocked in both sample and production quantities. This supplement is not representative of the entire Tyco Electronics Eurostyle offering. Additional position sizes, pin spacings, product solutions and information can be found at <http://www.tycoelectronics.com/industrial/>.

The intent of this catalog supplement is to provide some focus on the most commonly used products and position sizes. Included are product technologies such as Rising Cage Clamp, Wire Protector, Spring Cage, and IDC (Pivot Block). These technologies are suitable as solutions for common applications such as high density requirements, standard signal requirements, and high power applications.

## Table of Contents

One-Piece Board Mount	
Side Wire Entry .....	3
Board Mount Multi-Level	
Stacking, 1st and 2nd Level .....	4
Top Wire Entry .....	4
35° Angle Wire Entry .....	4
High Current, PCB Mount,	
Side Wire Entry .....	4
Wire Protector Style.....	4
Two-Piece	
Headers	
Headers .....	5
Headers with Screw Flanges .....	6
Double-Row Headers.....	6
Unshrouded Pin Headers .....	6
Plugs	
Plugs .....	7
Plugs with Screw Flanges .....	8
90°/180° Plug Rising Cage Style .....	9
90°/180° Plug Wire Protector Style.....	9
Screwless Connectors	
Spring Top Wire Entry .....	9
Spring Side Wire Entry .....	9
Insulation Displacement Pivot Block .....	9
Wire Trap Surface Mount.....	9
Technology Overview .....	10,11

**ONE PIECE CONNECTORS**

**Board Mount Side Wire Entry, (Vertical)**

*2.54 mm Centerline*

282834-2	2 position, 150V, 10A, 16-30 AWG, Green
282834-3	3 position, 150V, 10A, 16-30 AWG, Green
282834-4	4 position, 150V, 10A, 16-30 AWG, Green
282834-5	5 position, 150V, 10A, 16-30 AWG, Green
282834-6	6 position, 150V, 10A, 16-30 AWG, Green
282834-8	8 position, 150V, 10A, 16-30 AWG, Green

*3.5 mm Centerline, 12.6mm Profile - with Interlock*

284391-2	2 position, with Interlock, 300V,12A, 14-30 AWG, Green
284391-3	3 position, with Interlock, 300V,12A, 14-30 AWG, Green
284391-4	4 position, with Interlock, 300V,12A, 14-30 AWG, Green
284391-5	5 position, with Interlock, 300V,12A, 14-30 AWG, Green
284391-6	6 position, with Interlock, 300V,12A, 14-30 AWG, Green
284391-8	8 position, with Interlock, 300V,12A, 14-30 AWG, Green

*3.5mm Centerline, 8.5mm Profile, High Temp*

1776112-2	2 position, w/out Interlock, 300V, 12A, 16-28 AWG, Black
1776112-3	3 position, w/out Interlock, 300V, 12A, 16-28 AWG, Black
1776112-4	4 position, w/out Interlock, 300V, 12A, 16-28 AWG, Black

*3.81mm Centerline, 12.6mm Profile - with Interlock*

284392-2	2 position, with Interlock, 300V, 12A, 14-30 AWG, Green
284392-3	3 position, with Interlock, 300V, 12A, 14-30 AWG, Green
284392-4	4 position, with Interlock, 300V, 12A, 14-30 AWG, Green
284392-5	5 position, with Interlock, 300V, 12A, 14-30 AWG, Green
284392-6	6 position, with Interlock, 300V, 12A, 14-30 AWG, Green
284392-8	8 position, with Interlock, 300V, 12A, 14-30 AWG, Green

*3.81mm Centerline, 8.5mm Profile, High Temp*

1776113-2	2 position, w/out Interlock, 150V, 12A, 16-28 AWG, Black
1776113-3	3 position, w/out Interlock, 150V, 12A, 16-28 AWG, Black
1776113-4	4 position, w/out Interlock, 150V, 12A, 16-28 AWG, Black
1776113-5	5 position, w/out Interlock, 150V, 12A, 16-28 AWG, Black
1776113-6	6 position, w/out Interlock, 150V, 12A, 16-28 AWG, Black
1776113-8	8 position, w/out Interlock, 150V, 12A, 16-28 AWG, Black

*5.0mm Centerline, Low Profile - with Interlock*

282836-2	2 position, with Interlock, 300V, 10A, 16-30 AWG, Green
282836-3	3 position, with Interlock, 300V, 10A, 16-30 AWG, Green
282836-4	4 position, with Interlock, 300V, 10A, 16-30 AWG, Green
282836-5	5 position, with Interlock, 300V, 10A, 16-30 AWG, Green
282836-6	6 position, with Interlock, 300V, 10A, 16-30 AWG, Green
282836-8	8 position, with Interlock, 300V, 10A, 16-30 AWG, Green

*5.0mm Centerline, 15.2mm Profile - with Interlock*

796683-2	2 position, with Interlock, 300V, 15A, 12-30 AWG, Green
796683-3	3 position, with Interlock, 300V, 15A, 12-30 AWG, Green
796683-4	4 position, with Interlock, 300V, 15A, 12-30 AWG, Green
796683-8	8 position, with Interlock, 300V, 15A, 12-30 AWG, Green

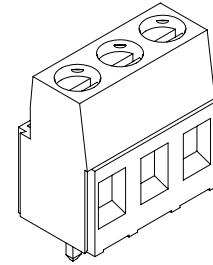

*5.0mm Centerline, 19.0mm Profile - with Interlock*

282856-2	2 position, With Interlock, 300V, 20A, 12-30 AWG, Green
282856-3	3 position, With Interlock, 300V, 20A, 12-30 AWG, Green
282856-4	4 position, With Interlock, 300V, 20A, 12-30 AWG, Green
282856-5	5 position, With Interlock, 300V, 20A, 12-30 AWG, Green
282856-6	6 position, With Interlock, 300V, 20A, 12-30 AWG, Green
282856-8	8 position, With Interlock, 300V, 20A, 12-30 AWG, Green

*5.08mm Centerline, Low Profile High Temp - with Interlock*

1776119-2	2 Position, With Interlock, 300V, 10A, 16-30 AWG, Black
1776119-3	3 Position, With Interlock, 300V, 10A, 16-30 AWG, Black
1776119-8	8 Position, With Interlock, 300V, 10A, 16-30 AWG, Black

*5.08mm Centerline, 15.2mm Profile - with Interlock*

282841-2	2 Position, With Interlock, 300V, 15A, 12-30 AWG, Green
282841-3	3 Position, With Interlock, 300V, 15A, 12-30 AWG, Green
282841-4	4 Position, With Interlock, 300V, 15A, 12-30 AWG, Green
282841-5	5 Position, With Interlock, 300V, 15A, 12-30 AWG, Green
282841-6	6 Position, With Interlock, 300V, 15A, 12-30 AWG, Green
282841-8	8 Position, With Interlock, 300V, 15A, 12-30 AWG, Green

*5.08mm Centerline, 19.0mm Profile - with Interlock*

282857-2	2 Position, With Interlock, 300V, 20A, 12-30 AWG, Green
282857-3	3 Position, With Interlock, 300V, 20A, 12-30 AWG, Green
282857-4	4 Position, With Interlock, 300V, 20A, 12-30 AWG, Green
282857-5	5 Position, With Interlock, 300V, 20A, 12-30 AWG, Green
282857-6	6 Position, With Interlock, 300V, 20A, 12-30 AWG, Green
282857-8	8 Position, With Interlock, 300V, 20A, 12-30 AWG, Green

*7.5mm Centerline, 15.2mm Profile - with Interlock*

282844-2	2 Position, With Interlock, 300V, 15A, 12-30 AWG, Green
282844-3	3 Position, With Interlock, 300V, 15A, 12-30 AWG, Green
282844-4	4 Position, With Interlock, 300V, 15A, 12-30 AWG, Green

*7.62mm Centerline, 15.2 Profile - with Interlock*

282845-2	2 Position, With Interlock, 300V, 15A, 12-30 AWG, Green
282845-3	3 Position, With Interlock, 300V, 15A, 12-30 AWG, Green

*10.0mm Centerline, 19.0mm Profile - with Interlock*

282858-2	2 Position, With Interlock, 600V, 20A, 12-30 AWG, Green
282858-3	3 Position, With Interlock, 600V, 20A, 12-30 AWG, Green
282858-4	4 Position, With Interlock, 600V, 20A, 12-30 AWG, Green

*10.16mm Centerline, 15.2mm Profile - with Interlock*

282843-2	2 Position, With Interlock, 600V, 15A, 12-30 AWG, Green
282843-3	3 Position, With Interlock, 600V, 15A, 12-30 AWG, Green
282843-4	4 Position, With Interlock, 600V, 15A, 12-30 AWG, Green

**ONE PIECE CONNECTORS**

**Board Mount Multi-Level Stacking, 1st and 2nd Level**

*5.0mm Centerline, 25.2mm Profile - with Interlock*

- 282888-2 2 Position, With Interlock, 300V, 15A, 12-30 AWG, Green
- 282888-3 3 Position, With Interlock, 300V, 15A, 12-30 AWG, Green

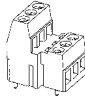

*5.08mm Centerline, 25.2mm Profile - with Interlock*

- 796692-2 2 Position, With Interlock, 300V, 15A, 12-30 AWG, Green
- 796692-3 3 Position, With Interlock, 300V, 15A, 12-30 AWG, Green

**Board Mount Top Wire Entry (Right Angle)**

*5.0mm Centerline, 8.2mm Profile - with Interlock*

- 284093-2 2 Position, With Interlock, 300V, 10A, 16-30 AWG, Green
- 284093-3 3 Position, With Interlock, 300V, 10A, 16-30 AWG, Green
- 284093-4 4 Position, With Interlock, 300V, 10A, 16-30 AWG, Green

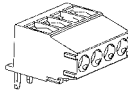

*5.08mm Centerline, 9.0mm Profile - with Interlock*

- 282851-2 2 Position, With Interlock, 300V, 15A, 12-30 AWG, Green
- 282851-3 3 Position, With Interlock, 300V, 15A, 12-30 AWG, Green
- 282851-4 4 Position, With Interlock, 300V, 15A, 12-30 AWG, Green

**Board Mount 35° Angled Wire Entry**

*5.0mm Centerline, 15.0mm Profile - with Interlock*

- 796689-2 2 Position, With Interlock, 300V, 15A, 12-30 AWG, Black
- 796689-3 3 Position, With Interlock, 300V, 15A, 12-30 AWG, Black
- 796690-2 4 Position, With Interlock, 300V, 15A, 12-30 AWG, Green
- 796690-3 5 Position, With Interlock, 300V, 15A, 12-30 AWG, Green

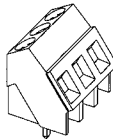

*5.08mm Centerline, 15.0mm Profile - with Interlock*

- 282847-2 2 Position, With Interlock, 300V, 15A, 12-30 AWG, Green
- 282847-3 3 Position, With Interlock, 300V, 15A, 12-30 AWG, Green
- 282847-4 4 Position, With Interlock, 300V, 15A, 12-30 AWG, Green

**High Current PCB Mount, Side Wire Entry**

*6.35mm Centerline, 21.5mm Profile - with Interlock*

- 796740-2 2 Position, With Interlock, 300V, 30A, 10-24 AWG, Green
- 796740-3 3 Position, With Interlock, 300V, 30A, 10-24 AWG, Green



*9.52mm Centerline, 21.5mm Profile - with Interlock*

- 796739-2 2 Position, With Interlock, 600V, 30A, 10-24 AWG, Green
- 796739-3 3 Position, With Interlock, 600V, 30A, 10-24 AWG, Green

*10.16mm Centerline, 29.50mm Profile - with Interlock*

- 1776886-2 2 Position, With Interlock, 300V, 52A, 6-8 AWG, Green
- 1776886-3 3 Position, With Interlock, 300V, 52A, 6-8 AWG, Green

*15.0mm Centerline, 39.0mm Profile - with Interlock*

- 1986242-2 2 Position, With Interlock, 600V, 125A, 1-20 AWG, Green
- 1986242-3 3 Position, With Interlock, 600V, 125A, 1-20 AWG, Green

**Wire Protector Versions**

*3.5mm Centerline, PCB Mt, Side Wire Entry, - with Interlock*

- 1776275-2 2 Position, 250V, 7A, 18-26 AWG, Blue
- 1776275-3 3 Position, 250V, 7A, 18-26 AWG, Blue
- 1776275-4 4 Position, 250V, 7A, 18-26 AWG, Blue
- 1776275-5 5 Position, 250V, 7A, 18-26 AWG, Blue

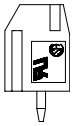

*5.0mm Centerline, PCB Mt, Side Wire Entry, - with Interlock*

- 1776244-2 2 Position, 250V, 10A, 14-22 AWG, Blue
- 1776244-3 3 Position, 250V, 10A, 14-22 AWG, Blue
- 1776244-4 4 Position, 250V, 10A, 14-22 AWG, Blue
- 1776244-5 5 Position, 250V, 10A, 14-22 AWG, Blue

*5.0mm Centerline, 45° Wire Inlet - with Interlock*

- 1776252-2 2 Position, 250V, 10A, 14-22 AWG, Blue
- 1776252-3 3 Position, 250V, 10A, 14-22 AWG, Blue
- 1776252-4 4 Position, 250V, 10A, 14-22 AWG, Blue
- 1776252-5 5 Position, 250V, 10A, 14-22 AWG, Blue



**ONE PIECE CONNECTORS**

**Headers**

*3.5mm Centerline, Straight Closed End Header*

284514-2	2 Position, 300V, 11A, Green
284514-3	3 Position, 300V, 11A, Green
284514-4	4 Position, 300V, 11A, Green
284514-5	5 Position, 300V, 11A, Green
284514-6	6 Position, 300V, 11A, Green
284514-8	8 Position, 300V, 11A, Green
1-284514-0	10 Position, 300V, 11A, Green
1-284514-2	12 Position, 300V, 11A, Green

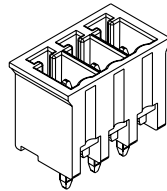

*3.5mm Centerline, Right Angle Closed End Header*

284512-2	2 Position, 300V, 11A, Green
284512-3	3 Position, 300V, 11A, Green
284512-4	4 Position, 300V, 11A, Green
284512-5	5 Position, 300V, 11A, Green
284512-6	6 Position, 300V, 11A, Green
284512-8	8 Position, 300V, 11A, Green
1-284512-0	10 Position, 300V, 11A, Green
1-284512-2	12 Position, 300V, 11A, Green

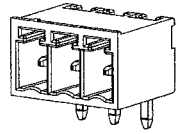

*3.81mm Centerline, Straight Closed End Header*

284517-2	2 Position, 300V, 11A, Green
284517-3	3 Position, 300V, 11A, Green
284517-4	4 Position, 300V, 11A, Green
284517-5	5 Position, 300V, 11A, Green
284517-6	6 Position, 300V, 11A, Green
284517-8	8 Position, 300V, 11A, Green
1-284517-0	10 Position, 300V, 11A, Green
1-284517-2	12 Position, 300V, 11A, Green

*3.81mm Centerline, Right Angle Closed End Header*

284513-2	2 Position, 300V, 11A, Green
284513-3	3 Position, 300V, 11A, Green
284513-4	4 Position, 300V, 11A, Green
284513-5	5 Position, 300V, 11A, Green
284513-6	6 Position, 300V, 11A, Green
284513-8	8 Position, 300V, 11A, Green
1-284513-0	10 Position, 300V, 11A, Green
1-284513-2	12 Position, 300V, 11A, Green

*5.0mm Centerline, Straight Closed End Header*

796642-2	2 Position, 300V, 15A, Green
796642-3	3 Position, 300V, 15A, Green
796642-4	4 Position, 300V, 15A, Green
796642-5	5 Position, 300V, 15A, Green
796642-6	6 Position, 300V, 15A, Green
796642-8	8 Position, 300V, 15A, Green
1-796642-0	10 Position, 300V, 15A, Green
1-796642-2	12 Position, 300V, 15A, Green

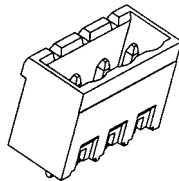

*5.0mm Centerline, Right Angle Closed End Header*

796644-2	2 Position, 300V, 15A, Green
796644-3	3 Position, 300V, 15A, Green
796644-4	4 Position, 300V, 15A, Green
796644-5	5 Position, 300V, 15A, Green
796644-6	6 Position, 300V, 15A, Green
796644-8	8 Position, 300V, 15A, Green
1-796644-0	10 Position, 300V, 15A, Green
1-796644-2	12 Position, 300V, 15A, Green

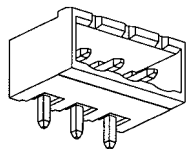

*5.08mm Centerline, Straight Closed End Header*

796636-2	2 Position, 300V, 15A, Green
796636-3	3 Position, 300V, 15A, Green
796636-4	4 Position, 300V, 15A, Green
796636-5	5 Position, 300V, 15A, Green
796636-6	6 Position, 300V, 15A, Green
796636-8	8 Position, 300V, 15A, Green
1-796636-0	10 Position, 300V, 15A, Green
1-796636-2	12 Position, 300V, 15A, Green

*5.08mm Centerline, Right Angle Closed End Header*

796638-2	2 Position, 300V, 15A, Green
796638-3	3 Position, 300V, 15A, Green
796638-4	4 Position, 300V, 15A, Green
796638-5	5 Position, 300V, 15A, Green
796638-6	6 Position, 300V, 15A, Green
796638-8	8 Position, 300V, 15A, Green
1-796638-0	10 Position, 300V, 15A, Green
1-796638-2	12 Position, 300V, 15A, Green

*5.0mm Centerline, Straight Open End Header*

282822-2	2 Position, 300V, 15A, Green
282822-3	3 Position, 300V, 15A, Green
282822-4	4 Position, 300V, 15A, Green
282822-5	5 Position, 300V, 15A, Green
282822-6	6 Position, 300V, 15A, Green
282822-8	8 Position, 300V, 15A, Green

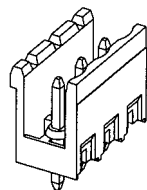

*5.0mm Centerline, Right Angle Open End Header with Interlock*

282811-2	2 Position, 300V, 15A, Green
282811-3	3 Position, 300V, 15A, Green
282811-4	4 Position, 300V, 15A, Green

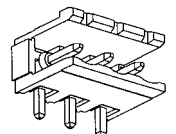

*5.08mm Centerline, Straight Open End Header*

282825-2	2 Position, 300V, 15A, Green
282825-3	3 Position, 300V, 15A, Green
282825-4	4 Position, 300V, 15A, Green
282825-5	5 Position, 300V, 15A, Green
282825-6	6 Position, 300V, 15A, Green
282825-8	8 Position, 300V, 15A, Green

*5.08mm Centerline, Right Angle Open End Header with Interlock*

282814-2	2 Position, 300V, 15A, Green
282814-3	3 Position, 300V, 15A, Green
282814-4	4 Position, 300V, 15A, Green

## TWO PIECE CONNECTORS

### Headers with Flanges

#### 3.5mm Centerline, Straight Header with Threaded Flange

284516-2	2 Position, 300V, 11A, Green
284516-3	3 Position, 300V, 11A, Green
284516-4	4 Position, 300V, 11A, Green
284516-5	5 Position, 300V, 11A, Green
284516-6	6 Position, 300V, 11A, Green
284516-8	8 Position, 300V, 11A, Green

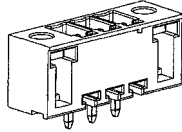

#### 3.81mm Centerline, Straight Header with Threaded Flange

284519-2	2 Position, 300V, 11A, Green
284519-3	3 Position, 300V, 11A, Green
284519-4	4 Position, 300V, 11A, Green
284519-5	5 Position, 300V, 11A, Green
284519-6	6 Position, 300V, 11A, Green
284519-8	8 Position, 300V, 11A, Green

#### 5.08mm Centerline, Straight Header with Threaded Flange

796867-2	2 Position, 300V, 15A, Green
796867-3	3 Position, 300V, 15A, Green
796867-4	4 Position, 300V, 15A, Green
796867-5	5 Position, 300V, 15A, Green
796867-6	6 Position, 300V, 15A, Green
796867-8	8 Position, 300V, 15A, Green

#### 3.5mm Centerline, Right Angle Header with Threaded Flange

284539-2	2 Position, 300V, 11A, Green
284539-3	3 Position, 300V, 11A, Green
284539-4	4 Position, 300V, 11A, Green
284539-5	5 Position, 300V, 11A, Green
284539-6	6 Position, 300V, 11A, Green
284539-8	8 Position, 300V, 11A, Green

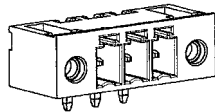

#### 3.81mm Centerline, Right Angle Header with Threaded Flange

284541-2	2 Position, 300V, 11A, Green
284541-3	3 Position, 300V, 11A, Green
284541-4	4 Position, 300V, 11A, Green
284541-5	5 Position, 300V, 11A, Green
284541-6	6 Position, 300V, 11A, Green
284541-8	8 Position, 300V, 11A, Green

#### 5.0mm Centerline, Right Angle Header with Threaded Flange

796864-2	2 Position, 300V, 15A, Green
796864-3	3 Position, 300V, 15A, Green
796864-4	4 Position, 300V, 15A, Green
796864-5	5 Position, 300V, 15A, Green
796864-6	6 Position, 300V, 15A, Green
796864-8	8 Position, 300V, 15A, Green

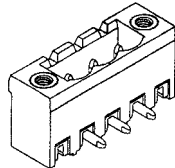

#### 5.08mm Centerline, Right Angle Header with Threaded Flange

796866-2	2 Position, 300V, 15A, Green
796866-3	3 Position, 300V, 15A, Green
796866-4	4 Position, 300V, 15A, Green
796866-5	5 Position, 300V, 15A, Green
796866-6	6 Position, 300V, 15A, Green
796866-8	8 Position, 300V, 15A, Green

### Double Row Headers

#### 5.0mm Centerline, Straight, Open End, Double-Row Header with Interlock

284056-2	2 Position, 300V, 15A, Green
284056-3	3 Position, 300V, 15A, Green
284056-4	4 Position, 300V, 15A, Green
284056-5	5 Position, 300V, 15A, Green

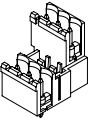

#### 5.08mm Centerline, Straight, Closed End, Double Row Header

284065-2	2 Position, 300V, 15A, Green
284065-3	3 Position, 300V, 15A, Green
284065-4	4 Position, 300V, 15A, Green
284065-5	5 Position, 300V, 15A, Green

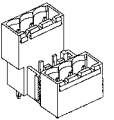

#### 5.0mm Centerline, Right Angle, Closed End, Double-Row Header

1776166-2	2 Position, 300V, 15A, High Temp, Black
1776166-3	3 Position, 300V, 15A, High Temp, Black
1776166-4	4 Position, 300V, 15A, High Temp, Black
1776166-5	5 Position, 300V, 15A, High Temp, Black

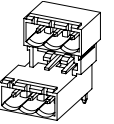

#### 5.08mm Centerline, Right Angle, Closed End, Double-Row Header

284061-2	2 Position, 300V, 15A, Green
284061-3	3 Position, 300V, 15A, Green
284061-4	4 Position, 300V, 15A, Green
284061-5	5 Position, 300V, 15A, Green

### Unshrouded Pin Headers

#### 5.0mm Centerline, Unshrouded Straight Pin Headers

1546931-2	2 Position, 300V, 12A, High Temperature, Black
1546931-3	3 Position, 300V, 12A, High Temperature, Black
1546931-4	4 Position, 300V, 12A, High Temperature, Black
1546931-5	5 Position, 300V, 12A, High Temperature, Black
1546931-6	6 Position, 300V, 12A, High Temperature, Black
1546931-8	8 Position, 300V, 12A, High Temperature, Black
1-1546931-0	10 Position, 300V, 12A, High Temperature, Black
1-1546931-2	12 Position, 300V, 12A, High Temperature, Black
2-1546931-5	25 Position, 300V, 12A, High Temperature, Black

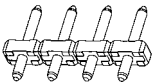

## TWO PIECE CONNECTORS

### Plugs

#### 3.5mm Centerline, Right Angle Plug

284506-2	2 Position, 300V, 11A, 14-30 AWG, Green
284506-3	3 Position, 300V, 11A, 14-30 AWG, Green
284506-4	4 Position, 300V, 11A, 14-30 AWG, Green
284506-5	5 Position, 300V, 11A, 14-30 AWG, Green
284506-6	6 Position, 300V, 11A, 14-30 AWG, Green
284506-8	8 Position, 300V, 11A, 14-30 AWG, Green
1-284506-0	10 Position, 300V, 11A, 14-30 AWG, Green
1-284506-2	12 Position, 300V, 11A, 14-30 AWG, Green

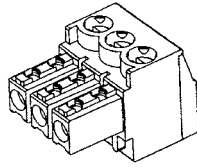

#### 3.81mm Centerline, Right Angle Plug

284507-2	2 Position, 300V, 11A, 14-30 AWG, Green
284507-3	3 Position, 300V, 11A, 14-30 AWG, Green
284507-4	4 Position, 300V, 11A, 14-30 AWG, Green
284507-5	5 Position, 300V, 11A, 14-30 AWG, Green
284507-6	6 Position, 300V, 11A, 14-30 AWG, Green
284507-8	8 Position, 300V, 11A, 14-30 AWG, Green
1-284507-0	10 Position, 300V, 11A, 14-30 AWG, Green
1-284507-2	12 Position, 300V, 11A, 14-30 AWG, Green

#### 5.0mm Centerline, Right Angle Plug

796640-2	2 Position, 300V, 15A, 12-30 AWG, Green
796640-3	3 Position, 300V, 15A, 12-30 AWG, Green
796640-4	4 Position, 300V, 15A, 12-30 AWG, Green
796640-5	5 Position, 300V, 15A, 12-30 AWG, Green
796640-6	6 Position, 300V, 15A, 12-30 AWG, Green
796640-8	8 Position, 300V, 15A, 12-30 AWG, Green
1-796640-0	10 Position, 300V, 15A, 12-30 AWG, Green
1-796640-2	12 Position, 300V, 15A, 12-30 AWG, Green

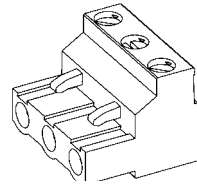

#### 5.08mm Centerline, Right Angle Plug

796634-2	2 Position, 300V, 15A, 12-30 AWG, Green
796634-3	3 Position, 300V, 15A, 12-30 AWG, Green
796634-4	4 Position, 300V, 15A, 12-30 AWG, Green
796634-5	5 Position, 300V, 15A, 12-30 AWG, Green
796634-6	6 Position, 300V, 15A, 12-30 AWG, Green
796634-8	8 Position, 300V, 15A, 12-30 AWG, Green
1-796634-0	10 Position, 300V, 15A, 12-30 AWG, Green
1-796634-2	12 Position, 300V, 15A, 12-30 AWG, Green

#### 5.0mm Centerline, Straight Plug (LH)

284040-2	2 Position, 300V, 15A, 12-30 AWG, Green
284040-3	3 Position, 300V, 15A, 12-30 AWG, Green
284040-4	4 Position, 300V, 15A, 12-30 AWG, Green
284040-5	5 Position, 300V, 15A, 12-30 AWG, Green
284040-6	6 Position, 300V, 15A, 12-30 AWG, Green
284040-8	8 Position, 300V, 15A, 12-30 AWG, Green
1-284040-0	10 Position, 300V, 15A, 12-30 AWG, Green
1-284040-2	12 Position, 300V, 15A, 12-30 AWG, Green

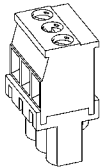

#### 5.08mm Centerline, Straight Plug (LH)

284041-2	2 Position, 300V, 15A, 12-30 AWG, Green
284041-3	3 Position, 300V, 15A, 12-30 AWG, Green
284041-4	4 Position, 300V, 15A, 12-30 AWG, Green
284041-5	5 Position, 300V, 15A, 12-30 AWG, Green
284041-6	6 Position, 300V, 15A, 12-30 AWG, Green
284041-8	8 Position, 300V, 15A, 12-30 AWG, Green
1-284041-0	10 Position, 300V, 15A, 12-30 AWG, Green
1-284041-2	12 Position, 300V, 15A, 12-30 AWG, Green

#### 5.0mm Centerline, Straight Plug (RH)

284046-2	2 Position, 300V, 15A, 12-30 AWG, Green
284046-3	3 Position, 300V, 15A, 12-30 AWG, Green
284046-4	4 Position, 300V, 15A, 12-30 AWG, Green
284046-5	5 Position, 300V, 15A, 12-30 AWG, Green
284046-6	6 Position, 300V, 15A, 12-30 AWG, Green
284046-8	8 Position, 300V, 15A, 12-30 AWG, Green
1-284046-0	10 Position, 300V, 15A, 12-30 AWG, Green
1-284046-2	12 Position, 300V, 15A, 12-30 AWG, Green

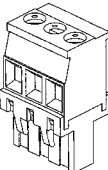

#### 5.08mm Centerline, Straight Plug (RH)

284047-2	2 Position, 300V, 15A, 12-30 AWG, Green
284047-3	3 Position, 300V, 15A, 12-30 AWG, Green
284047-4	4 Position, 300V, 15A, 12-30 AWG, Green
284047-5	5 Position, 300V, 15A, 12-30 AWG, Green
284047-6	6 Position, 300V, 15A, 12-30 AWG, Green
284047-8	8 Position, 300V, 15A, 12-30 AWG, Green
1-284047-0	10 Position, 300V, 15A, 12-30 AWG, Green
1-284047-2	12 Position, 300V, 15A, 12-30 AWG, Green

## TWO PIECE CONNECTORS

### Plugs with Screw Flanges

#### *3.5mm Centerline, Right Angle Plug with Flange*

284510-2	2 Position, 300V, 11A, 14-30 AWG, Green
284510-3	3 Position, 300V, 11A, 14-30 AWG, Green
284510-4	4 Position, 300V, 11A, 14-30 AWG, Green
284510-5	5 Position, 300V, 11A, 14-30 AWG, Green
284510-6	6 Position, 300V, 11A, 14-30 AWG, Green
284510-8	8 Position, 300V, 11A, 14-30 AWG, Green

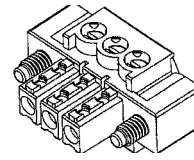

#### *3.81mm Centerline, Right Angle Plug with Flange*

284511-2	2 Position, 300V, 11A, 14-30 AWG, Green
284511-3	3 Position, 300V, 11A, 14-30 AWG, Green
284511-4	4 Position, 300V, 11A, 14-30 AWG, Green
284511-5	5 Position, 300V, 11A, 14-30 AWG, Green
284511-6	6 Position, 300V, 11A, 14-30 AWG, Green
284511-8	8 Position, 300V, 11A, 14-30 AWG, Green

#### *5.0mm Centerline, Right Angle Plug with Flange*

796858-2	2 Position, 300V, 15A 12-30 AWG, Green
796858-3	3 Position, 300V, 15A 12-30 AWG, Green
796858-4	4 Position, 300V, 15A 12-30 AWG, Green
796858-5	5 Position, 300V, 15A 12-30 AWG, Green
796858-6	6 Position, 300V, 15A 12-30 AWG, Green
796858-8	8 Position, 300V, 15A 12-30 AWG, Green

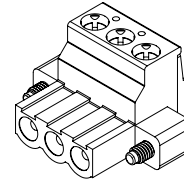

#### *5.08mm Centerline, Right Angle Plug with Flange*

796859-2	2 Position, 300V, 15A 12-30 AWG, Green
796859-3	3 Position, 300V, 15A 12-30 AWG, Green
796859-4	4 Position, 300V, 15A 12-30 AWG, Green
796859-5	5 Position, 300V, 15A 12-30 AWG, Green
796859-6	6 Position, 300V, 15A 12-30 AWG, Green
796859-8	8 Position, 300V, 15A 12-30 AWG, Green

#### *5.08mm Centerline, Straight Plug (LH ) with Flange*

796861-2	2 Position, 300V, 15A, 12-30 AWG, Green
796861-3	3 Position, 300V, 15A, 12-30 AWG, Green
796861-4	4 Position, 300V, 15A, 12-30 AWG, Green
796861-5	5 Position, 300V, 15A, 12-30 AWG, Green
796861-6	6 Position, 300V, 15A, 12-30 AWG, Green
796861-8	8 Position, 300V, 15A, 12-30 AWG, Green

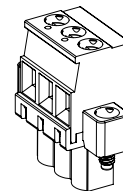

#### *5.08mm Centerline, Straight Plug (RH) with Flange*

796863-2	2 Position, 300V, 15A, 12-30 AWG, Green
796863-3	3 Position, 300V, 15A, 12-30 AWG, Green
796863-4	4 Position, 300V, 15A, 12-30 AWG, Green
796863-5	5 Position, 300V, 15A, 12-30 AWG, Green
796863-6	6 Position, 300V, 15A, 12-30 AWG, Green
796863-8	8 Position, 300V, 15A, 12-30 AWG, Green

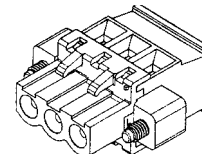



## TWO PIECE CONNECTORS

### Multi-Directional Two Piece Connectors

#### 5.0mm Centerline, 90°/180° Plug Connector, Rising Cage Style

282830-2	2 Position, 300V, 12A, 14-30 AWG, Green
282830-3	3 Position, 300V, 12A, 14-30 AWG, Green
282830-4	4 Position, 300V, 12A, 14-30 AWG, Green
282830-5	5 Position, 300V, 12A, 14-30 AWG, Green

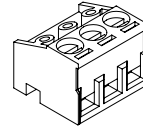

#### 5.0mm Centerline, , 90°/180° Plug Connector, Wire Protector Style

1776263-2	2 Position, 300V, 10A, 14-22 AWG, Blue
1776263-3	3 Position, 300V, 10A, 14-22 AWG, Blue
1776263-4	4 Position, 300V, 10A, 14-22 AWG, Blue
1776263-5	5 Position, 300V, 10A, 14-22 AWG, Blue

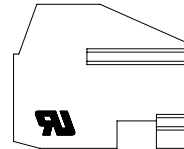

### Screwless Connectors

#### Board Mount Screwless, 5.0mm Centerline, Top Wire Entry - Spring

1776259-2	2 Position, 300V, 10A, 14-22 AWG, Green
1776259-3	3 Position, 300V, 10A, 14-22 AWG, Green
1776259-4	4 Position, 300V, 10A, 14-22 AWG, Green
1776259-5	5 Position, 300V, 10A, 14-22 AWG, Green
1776259-6	6 Position, 300V, 10A, 14-22 AWG, Green
1776259-8	8 Position, 300V, 10A, 14-22 AWG, Green

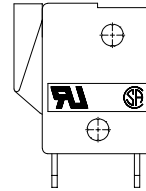

#### Board Mount Screwless, 5.08mm Centerline, Top Wire Entry - Spring

1776260-2	2 Position, 300V, 10A, 14-22 AWG, Green
1776260-3	3 Position, 300V, 10A, 14-22 AWG, Green
1776260-4	4 Position, 300V, 10A, 14-22 AWG, Green
1776260-5	5 Position, 300V, 10A, 14-22 AWG, Green
1776260-6	6 Position, 300V, 10A, 14-22 AWG, Green
1776260-8	8 Position, 300V, 10A, 14-22 AWG, Green

#### Board Mount Screwless, 5.08mm Centerline, Side Wire Entry

1437671-1	2 Position, 300V, 10A, 18-22 AWG, Black
1437671-4	3 Position, 300V, 10A, 18-22 AWG, Black
1437671-6	4 Position, 300V, 10A, 18-22 AWG, Black
1437671-7	5 Position, 300V, 10A, 18-22 AWG, Black
1437671-9	6 Position, 300V, 10A, 18-22 AWG, Black
1-1437671-1	8 Position, 300V, 10A, 18-22 AWG, Black



#### Pivot Block 3.5mm Centerline Plugs - Insulation Displacement

1776282-2	2 Position, 250V, 5A, 22-24 AWG, Green
1776282-3	3 Position, 250V, 5A, 22-24 AWG, Green
1776282-4	4 Position, 250V, 5A, 22-24 AWG, Green
1776282-5	5 Position, 250V, 5A, 22-24 AWG, Green
1776282-6	6 Position, 250V, 5A, 22-24 AWG, Green
1776282-8	8 Position, 250V, 5A, 22-24 AWG, Green
1776283-2	2 Position, 250V, 5A, 22-24 AWG, w/ Screw Flange, Green
1776283-3	3 Position, 250V, 5A, 22-24 AWG, w/ Screw Flange, Green
1776283-4	4 Position, 250V, 5A, 22-24 AWG, w/ Screw Flange, Green
1776283-5	5 Position, 250V, 5A, 22-24 AWG, w/ Screw Flange, Green
1776283-6	6 Position, 250V, 5A, 22-24 AWG, w/ Screw Flange, Green
1776283-8	8 Position, 250V, 5A, 22-24 AWG, w/ Screw Flange, Green

Note: Mates with any standard 3.5mm centerline headers with and without flanges.

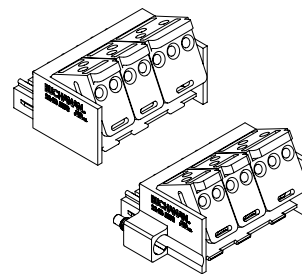

#### Surface Mount with Wire Trap, 2.5mm Centerline, 2 Position

1776226-1	250V, 3A, 24 AWG Stranded tin, Tape and Reel Packaged, Black
-----------	--

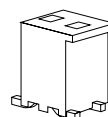

# Eurostyle Terminal Blocks

## TECHNOLOGY OVERVIEW

### Rising Cage Clamp

- Intended for use in industrial applications such as instrumentation, industrial controls, data acquisition, and industrial communications products
- Available in single piece PCB mount, or two piece pluggable configurations
- Contacts are supplied wire ready and with captive screws for convenience

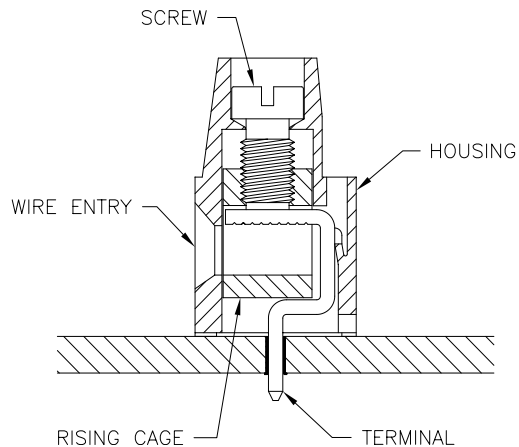

Wire termination is accomplished by first inserting a bare conductor into the wire entry area. Using a screwdriver, turn the screw in a clockwise direction, the applied torque causes the wire cage, or floor, to rise. The conductor is held firmly in place between the floor of the cage and the wire contact. To remove the conductor, simply rotate the screw in a counter clockwise direction to lower the wire cage and free the wire.

### Wire Protector

- Intended for use in lighter duty or commercial applications such as security and alarm, or HVAC controls
- Available in single piece PCB mount, or two piece pluggable configurations
- The wire protector prevents the screw from damaging the conductor and/or wire strands

Wire termination is accomplished by first inserting a bare conductor into the wire entry area. Using a screwdriver, turn the screw in a clockwise direction, the applied torque causes the screw to lower itself within the plastic housing. The lowering of the screw causes the wire protector to compress down and traps the conductor between the wire protector and the bottom of the wire cage. To remove the conductor, simply rotate the screw in a counter clockwise direction to lower the wire.

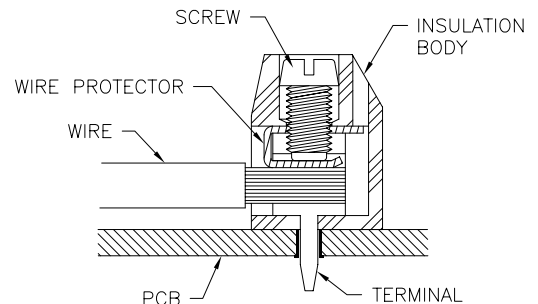

# Eurostyle Terminal Blocks

## TECHNOLOGY OVERVIEW

### Spring Cage

- Intended for use in industrial and commercial applications such as instrumentation, industrial controls, data acquisition, security & alarm, and HVAC controls
- Currently available in single piece PCB mount version
- Provides for faster wire termination than screw versions without sacrificing wire termination quality



Top wire entry versions are actuated with a finger or screwdriver. A lever is used to open the spring so that a wire may be inserted. First depress and hold the lever down, then insert a conductor into the wire entry area and release the lever. An internal spring retains the wire in the housing.

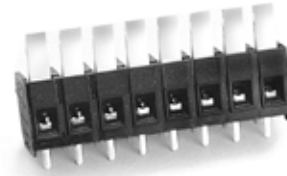

Side wire entry versions come in wire ready position. Insert conductor into the wire entry area and depress the lever with your finger. The lever activates an internal spring which retains the wire in the housing. To remove the conductor simply lift the lever wire is released.

### Insulation Displacement

- Intended for use in industrial communications and control applications such as analog or serial communications using 22-24 AWG wires and sensor wiring
- Available in two piece pluggable configurations
- Provides for very fast and easy field terminations of small gauge wires and eliminates the need to strip wires

Wire termination is accomplished by inserting an un-stripped conductor into the wire entry hole located on the stuffer. Insert the wire all the way until it bottoms. The clear wire stuffer allows for visual confirmation. Depress the stuffer down onto the contacts with your finger until it latches onto the housing. Screwdrivers may be used in the primary slot to aid in seating the stuffer, but are not required.

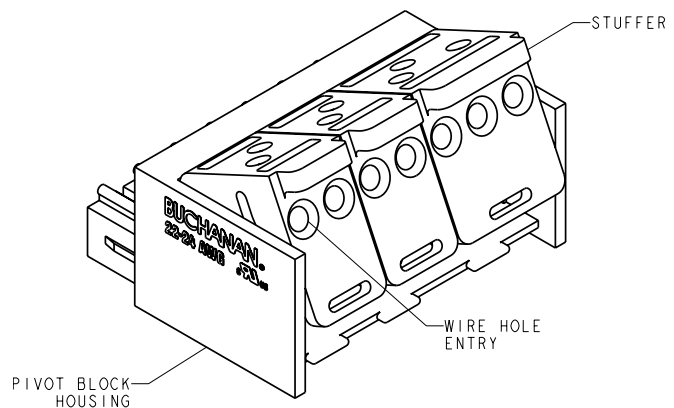

## FOR MORE INFORMATION

### Technical Support

Phone: 1-800-522-6752  
Internet: [www.tycoelectronics.com](http://www.tycoelectronics.com)

USA: 1-800-468-2023  
Germany: 49-89-6089-0  
Canada: 1-905-470-4425  
Mexico: 52-55-1106-0800  
C. America: 57-1-254-4444  
South America: 55-11-2103-6000  
Hong Kong: 852-2735-1628  
Japan: 81-44-844-8013  
UK: 44-208-420-8341

**Tyco Electronics Corporation**  
Harrisburg, PA

**[tycoelectronics.com](http://tycoelectronics.com)**

© 2008 by Tyco Electronics Corporation  
8-1773449-2-02-2008

the TE Logo and Tyco Electronics are trademarks.

