

LOW INPUT VOLTAGE, 0.7-V BOOST CONVERTER WITH 5.5- μ A QUIESCENT CURRENT

Check for Samples: [TPS61222-EP](#)

FEATURES

- Up to 95% Efficiency at Typical Operating Conditions
- 5.5 μ A Quiescent Current
- Startup Into Load at 0.7 V Input Voltage
- Operating Input Voltage from 0.7 V to 5.5 V
- Pass-Through Function During Shutdown
- Minimum Switching Current 200 mA
- Protections:
 - Output Overvoltage
 - Overtemperature
 - Input Undervoltage Lockout
- Fixed Output Voltage Versions
- Small 6-Pin SC-70 Package

APPLICATIONS

- Battery Powered Applications
 - 1 to 3 Cell Alkaline, NiCd or NiMH
 - 1 Cell Li-Ion or Li-Primary
- Solar or Fuel Cell Powered Applications
- Consumer and Portable Medical Products
- Personal Care Products
- White or Status LEDs
- Smartphones

SUPPORTS DEFENSE, AEROSPACE, AND MEDICAL APPLICATIONS

- Controlled Baseline
- One Assembly and Test Site
- One Fabrication Site
- Available in Military (-55°C to 125°C) Temperature Range ⁽¹⁾
- Extended Product Life Cycle
- Extended Product-Change Notification
- Product Traceability

(1) Custom temperature ranges available

DESCRIPTION

The TPS61222 provides a power-supply solution for products powered by either a single-cell, two-cell, or three-cell alkaline, NiCd or NiMH, or one-cell Li-Ion or Li-polymer battery. Possible output currents depend on the input-to-output voltage ratio. The boost converter is based on a hysteretic controller topology using synchronous rectification to obtain maximum efficiency at minimal quiescent currents. The output voltage of the adjustable version can be programmed by an external resistor divider, or is set internally to a fixed output voltage. The converter can be switched off by a featured enable pin. While being switched off, battery drain is minimized. The device is offered in a 6-pin SC-70 package (DCK) measuring 2 mm x 2 mm to enable small circuit layout size.



Please be aware that an important notice concerning availability, standard warranty, and use in critical applications of Texas Instruments semiconductor products and disclaimers thereto appears at the end of this data sheet.

TPS61222-EP

SLVSB12 – SEPTEMBER 2012

www.ti.com



This integrated circuit can be damaged by ESD. Texas Instruments recommends that all integrated circuits be handled with appropriate precautions. Failure to observe proper handling and installation procedures can cause damage.

ESD damage can range from subtle performance degradation to complete device failure. Precision integrated circuits may be more susceptible to damage because very small parametric changes could cause the device not to meet its published specifications.

AVAILABLE DEVICE OPTIONS⁽¹⁾

T _J	PACKAGE MARKING	PACKAGE ⁽²⁾	PART NUMBER	VID NUMBER
-55°C to 125°C	SHL	6-Pin SC-70	TPS61222MDCKTEP	V62/12603-01XE

- Contact the factory to check availability of other fixed output voltage versions.
- For the most current package and ordering information, see the Package Option Addendum at the end of this document, or see the TI website at www.ti.com.

ABSOLUTE MAXIMUM RATINGS

over operating free-air temperature range (unless otherwise noted)⁽¹⁾

			UNIT
V _{IN}	Input voltage range on VIN, L, VOUT, EN, FB	-0.3 to 7.5	V
T _J	Operating junction temperature range	-55 to 145	°C
T _{stg}	Storage temperature range	-65 to 150	°C
ESD	Human Body Model (HBM) ⁽²⁾	2	kV
	Machine Model (MM) ⁽²⁾	200	V
	Charged Device Model (CDM) ⁽²⁾	1.5	kV

- Stresses beyond those listed under *Absolute Maximum Ratings* may cause permanent damage to the device. These are stress ratings only, and functional operation of the device at these or any other conditions beyond those indicated under *Recommended Operating Conditions* is not implied. Exposure to absolute-maximum-rated conditions for extended periods may affect device reliability.
- ESD testing is performed according to the respective JESD22 JEDEC standard.

THERMAL INFORMATION

THERMAL METRIC ⁽¹⁾		TPS61222	UNITS
		DCK	
		6 PINS	
θ _{JA}	Junction-to-ambient thermal resistance ⁽²⁾	231.2	°C/W
θ _{JCtop}	Junction-to-case (top) thermal resistance ⁽³⁾	61.8	
θ _{JB}	Junction-to-board thermal resistance ⁽⁴⁾	78.8	
ψ _{JT}	Junction-to-top characterization parameter ⁽⁵⁾	2.2	
ψ _{JB}	Junction-to-board characterization parameter ⁽⁶⁾	78	
θ _{JCbot}	Junction-to-case (bottom) thermal resistance ⁽⁷⁾	N/A	

- For more information about traditional and new thermal metrics, see the *IC Package Thermal Metrics* application report, SPRA953.
- The junction-to-ambient thermal resistance under natural convection is obtained in a simulation on a JEDEC-standard, high-K board, as specified in JESD51-7, in an environment described in JESD51-2a.
- The junction-to-case (top) thermal resistance is obtained by simulating a cold plate test on the package top. No specific JEDEC-standard test exists, but a close description can be found in the ANSI SEMI standard G30-88.
- The junction-to-board thermal resistance is obtained by simulating in an environment with a ring cold plate fixture to control the PCB temperature, as described in JESD51-8.
- The junction-to-top characterization parameter, ψ_{JT}, estimates the junction temperature of a device in a real system and is extracted from the simulation data for obtaining θ_{JA}, using a procedure described in JESD51-2a (sections 6 and 7).
- The junction-to-board characterization parameter, ψ_{JB}, estimates the junction temperature of a device in a real system and is extracted from the simulation data for obtaining θ_{JA}, using a procedure described in JESD51-2a (sections 6 and 7).
- The junction-to-case (bottom) thermal resistance is obtained by simulating a cold plate test on the exposed (power) pad. No specific JEDEC standard test exists, but a close description can be found in the ANSI SEMI standard G30-88.

RECOMMENDED OPERATING CONDITIONS

		MIN	NOM	MAX	UNIT
V_{IN}	Supply voltage at V_{IN}	0.7		5.5	V
T_J	Operating free air temperature range	-55		125	°C

ELECTRICAL CHARACTERISTICS

$T_J = -55^{\circ}\text{C}$ to 125°C , $T_J = T_A$ and over recommended input voltage range (typical at an ambient temperature range of 25°C) (unless otherwise noted)

DC/DC STAGE						
PARAMETER		TEST CONDITIONS	MIN	TYP	MAX	UNIT
V_{IN}	Input voltage range		0.7		5.5	V
V_{IN}	Minimum input voltage at startup	$R_{Load} \geq 150 \Omega$			0.7	V
V_{OUT}	Output voltage (5 V)	$V_{IN} < V_{OUT}$	4.8	5	5.19	V
I_{LH}	Inductor current ripple			200		mA
I_{SW}	Switch current limit	$V_{OUT} = 5 \text{ V}$, $V_{IN} = 1.2 \text{ V}$	200	400		mA
R_{DSon_HSD}	Rectifying switch on resistance	$V_{OUT} = 5 \text{ V}$		700		m Ω
R_{DSon_LSD}	Main switch on resistance	$V_{OUT} = 5 \text{ V}$		550		m Ω
	Line regulation	$V_{IN} < V_{OUT}$		0.5		%
	Load regulation	$V_{IN} < V_{OUT}$		0.5		%
I_Q	Quiescent current	V_{IN}	$I_O = 0 \text{ mA}$, $V_{EN} = V_{IN} = 1.2 \text{ V}$, $V_{OUT} = 5 \text{ V}$	0.5	1.4	μA
		V_{OUT}		5	8.5	μA
I_{SD}	Shutdown current	$V_{EN} = 0 \text{ V}$, $V_{IN} = 1.2 \text{ V}$, $V_{OUT} \geq V_{IN}$		0.2	0.96	μA
I_{LKG_L}	Leakage current into L	$V_{EN} = 0 \text{ V}$, $V_{IN} = 1.2 \text{ V}$, $V_L = 1.2 \text{ V}$, $V_{OUT} \geq V_{IN}$		0.01	0.3	μA
I_{EN}	EN input current	Clamped on GND or V_{IN} ($V_{IN} < 1.5 \text{ V}$)		0.005	0.13	μA

CONTROL STAGE						
PARAMETER		TEST CONDITIONS	MIN	TYP	MAX	UNIT
V_{IL}	EN input low voltage	$V_{IN} \leq 1.5 \text{ V}$		$0.15 \times V_{IN}$		V
V_{IH}	EN input high voltage	$V_{IN} \leq 1.5 \text{ V}$	$0.8 \times V_{IN}$			V
V_{IL}	EN input low voltage	$5 \text{ V} > V_{IN} > 1.5 \text{ V}$			0.34	V
V_{IH}	EN input high voltage	$5 \text{ V} > V_{IN} > 1.5 \text{ V}$	1.28			V
V_{UVLO}	Undervoltage lockout threshold for turn off	V_{IN} decreasing		0.5	0.72	V
	Overshoot protection threshold		5.5		7.5	V
	Overtemperature protection			140		°C
	Overtemperature hysteresis			20		°C

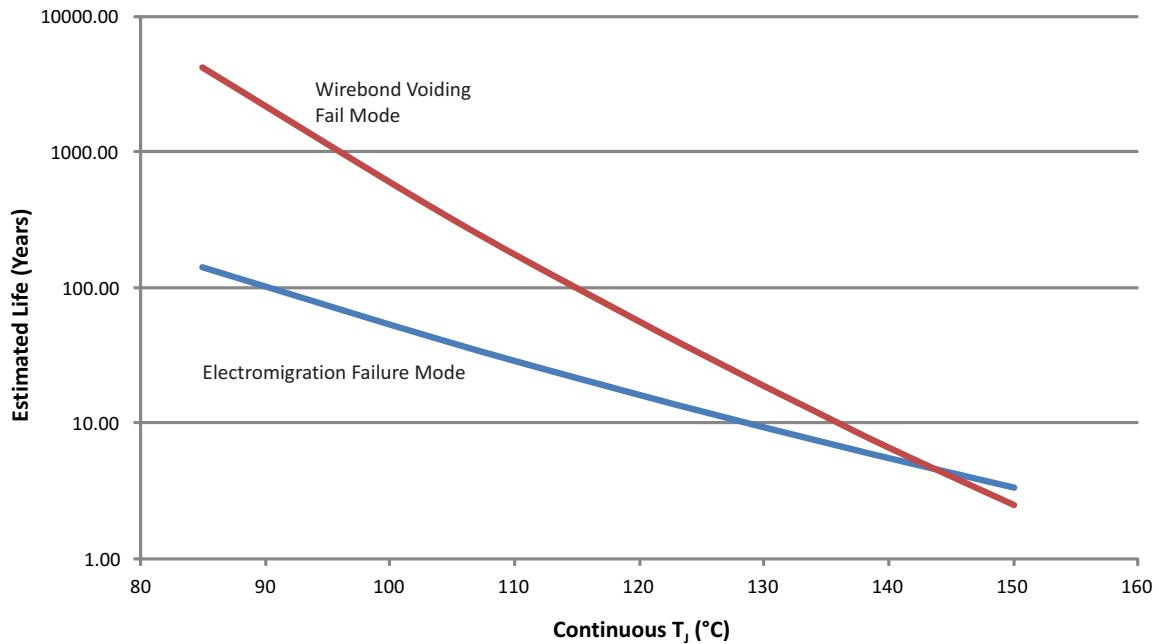

- (1) See data sheet for absolute maximum and minimum recommended operating conditions.
- (2) Silicon operating life design goal is 10 years at 105°C junction temperature (does not include package interconnect life).
- (3) Enhanced plastic product disclaimer applies.

Figure 1. TPS61222-EP Operating Life Derating Chart

PIN ASSIGNMENTS

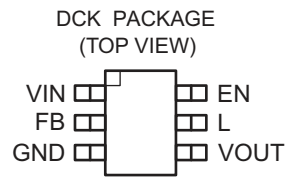

Terminal Functions

TERMINAL NAME	TERMINAL NO.	I/O	DESCRIPTION
EN	6	I	Enable input (1: enabled, 0: disabled). Must be actively tied high or low.
FB	2	I	Voltage feedback of adjustable version. Must be connected to V_{OUT} at fixed output voltage versions.
GND	3		Control / logic and power ground
L	5	I	Connection for Inductor
VIN	1	I	Boost converter input voltage
VOUT	4	O	Boost converter output voltage

FUNCTIONAL BLOCK DIAGRAM

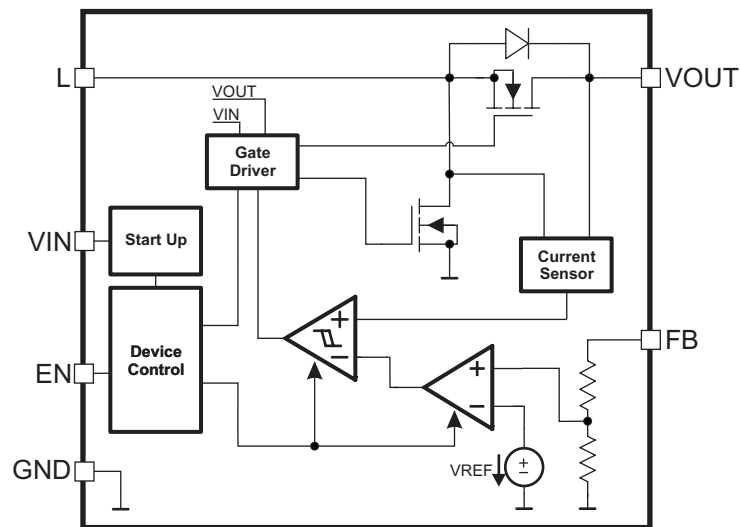

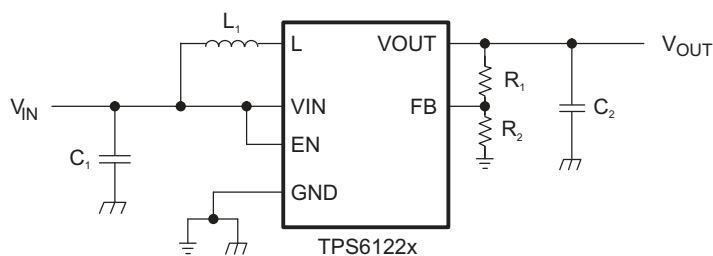
PARAMETER MEASUREMENT INFORMATION

Table 1. List of Components⁽¹⁾

COMPONENT REFERENCE	PART NUMBER	MANUFACTURER	VALUE
C ₁	GRM188R60J106ME84D	Murata	10 μF, 6.3V. X5R Ceramic
C ₂	GRM188R60J106ME84D	Murata	10 μF, 6.3V. X5R Ceramic
L ₁	EPL3015-472MLB	Coilcraft	4.7 μH
R ₁ , R ₂			adjustable version: Values depending on the programmed output voltage fixed version: R ₁ = 0 Ω, R ₂ not used

(1) Design was tested using these components at 25°C ambient temperature.

TYPICAL CHARACTERISTICS

Table of Graphs

		FIGURE
Maximum Output Current	vs Input Voltage	Figure 2
Efficiency	vs Output Current, $V_{IN} = [0.7\text{ V}; 1.2\text{ V}; 2.4\text{ V}; 3.6\text{ V}; 4.2\text{ V}]$	Figure 3
	vs Input Voltage, $I_{OUT} = [100\ \mu\text{A}; 1\text{ mA}; 10\text{ mA}; 50\text{ mA}]$	Figure 4
Input Current	at No Output Load, Device Enabled	Figure 5
Output Voltage	vs Output Current, $V_{IN} = [0.7\text{ V}; 1.2\text{ V}; 2.4\text{ V}; 3.6\text{ V}]$	Figure 6
Waveforms	Load Transient Response, $V_{IN} = 2.4\text{ V}$, $I_{OUT} = 14\text{ mA}$ to 126 mA	Figure 7
	Line Transient Response, $V_{IN} = 2.8\text{ V}$ to 3.6 V , $R_{LOAD} = 100\ \Omega$	Figure 8

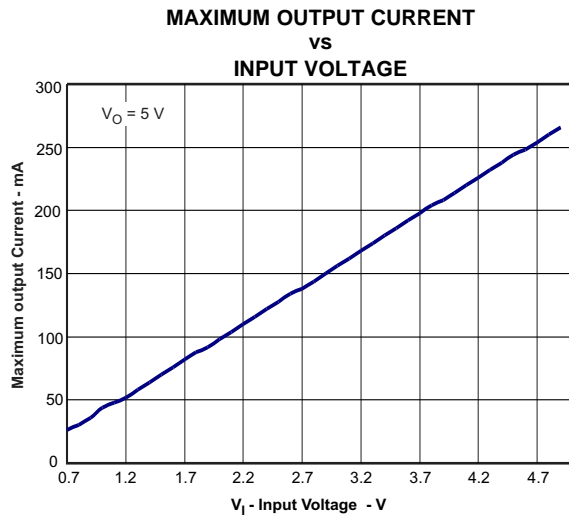

Figure 2.

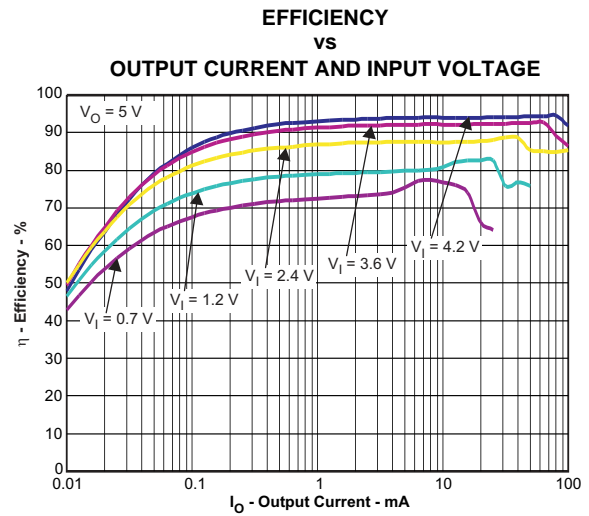

Figure 3.

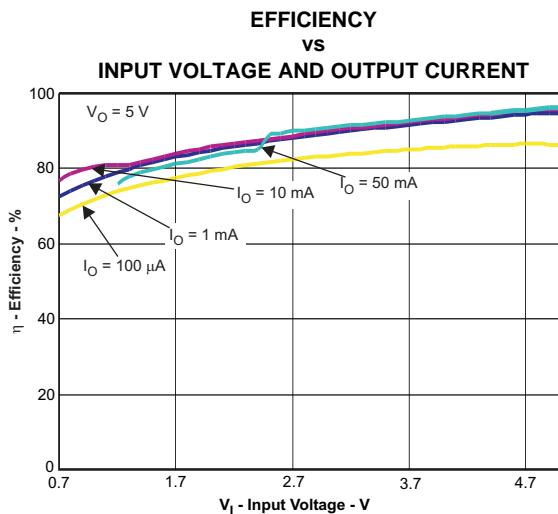

Figure 4.

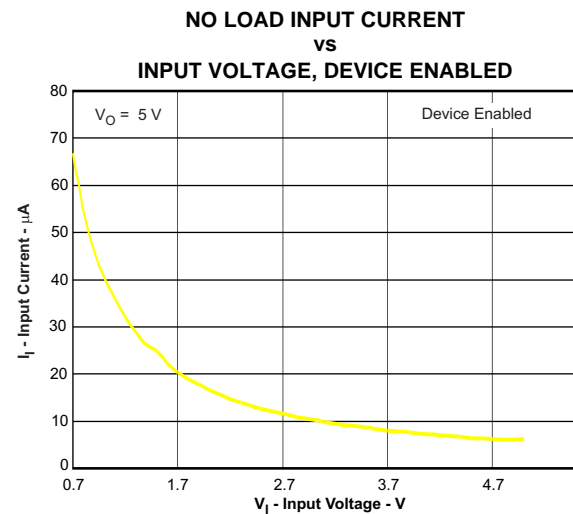

Figure 5.

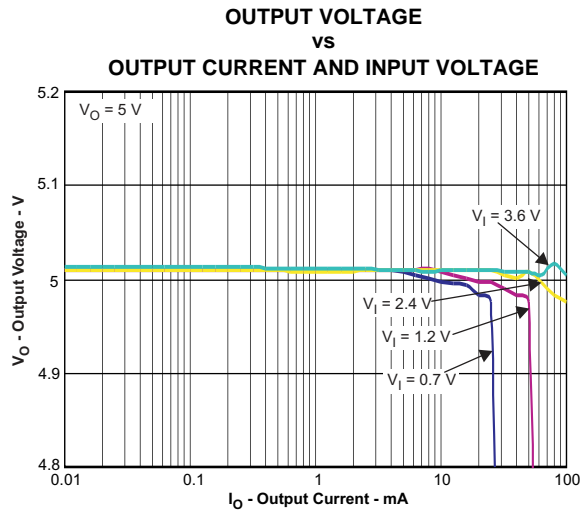

Figure 6.

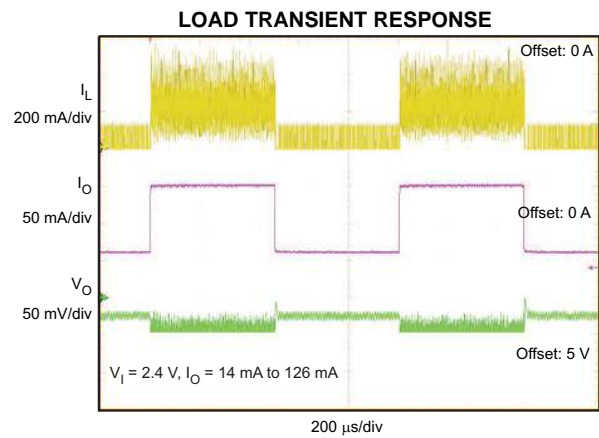

Figure 7.

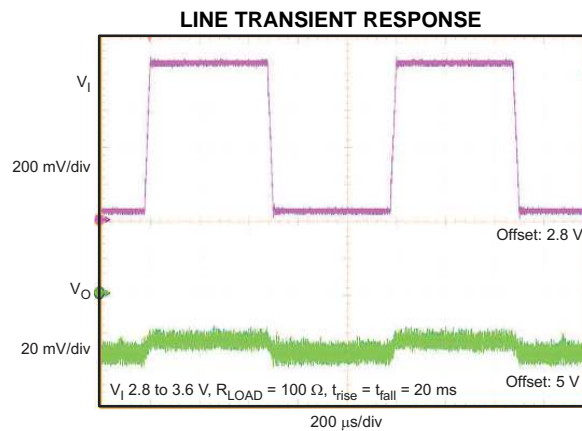

Figure 8.

DETAILED DESCRIPTION

OPERATION

The TPS61222 is a high performance, high efficient switching boost converter. To achieve high efficiency the power stage is realized as a synchronous boost topology. For the power switching two actively controlled low R_{DSon} power MOSFETs are implemented.

CONTROLLER CIRCUIT

The device is controlled by a hysteretic current mode controller. This controller regulates the output voltage by keeping the inductor ripple current constant in the range of 200 mA and adjusting the offset of this inductor current depending on the output load. In case the required average input current is lower than the average inductor current defined by this constant ripple the inductor current gets discontinuous to keep the efficiency high at low load conditions.

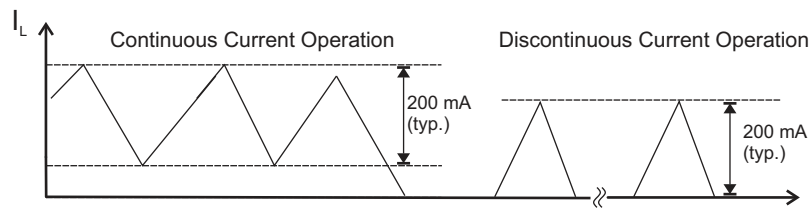

Figure 9. Hysteretic Current Operation

The output voltage V_{OUT} is monitored via the feedback network which is connected to the voltage error amplifier. To regulate the output voltage, the voltage error amplifier compares this feedback voltage to the internal voltage reference and adjusts the required offset of the inductor current accordingly. At fixed output voltage versions an internal feedback network is used to program the output voltage, at adjustable versions an external resistor divider needs to be connected.

The self oscillating hysteretic current mode architecture is inherently stable and allows fast response to load variations. It also allows using inductors and capacitors over a wide value range.

Device Enable and Shutdown Mode

The device is enabled when EN is set high and shut down when EN is low. During shutdown, the converter stops switching and all internal control circuitry is turned off. In this case the input voltage is connected to the output through the back-gate diode of the rectifying MOSFET. This means that there always will be voltage at the output which can be as high as the input voltage or lower depending on the load.

Startup

After the EN pin is tied high, the device starts to operate. In case the input voltage is not high enough to supply the control circuit properly a startup oscillator starts to operate the switches. During this phase the switching frequency is controlled by the oscillator and the maximum switch current is limited. As soon as the device has built up the output voltage to about 1.8V, high enough for supplying the control circuit, the device switches to its normal hysteretic current mode operation. The startup time depends on input voltage and load current.

Operation at Output Overload

If in normal boost operation the inductor current reaches the internal switch current limit threshold the main switch is turned off to stop further increase of the input current.

In this case the output voltage will decrease since the device can not provide sufficient power to maintain the set output voltage.

If the output voltage drops below the input voltage the backgate diode of the rectifying switch gets forward biased and current starts flow through it. This diode cannot be turned off, so the current finally is only limited by the remaining DC resistances. As soon as the overload condition is removed, the converter resumes providing the set output voltage.

Undervoltage Lockout

An implemented undervoltage lockout function stops the operation of the converter if the input voltage drops below the typical undervoltage lockout threshold. This function is implemented in order to prevent malfunctioning of the converter.

Overvoltage Protection

If, for any reason, the output voltage is not fed back properly to the input of the voltage amplifier, control of the output voltage will not work anymore. Therefore an overvoltage protection is implemented to avoid the output voltage exceeding critical values for the device and possibly for the system it is supplying. For this protection the TPS61222 output voltage is also monitored internally. In case it reaches the internally programmed threshold of 6.5 V typically the voltage amplifier regulates the output voltage to this value.

If the TPS61222 is used to drive LEDs, this feature protects the circuit if the LED fails.

Overtemperature Protection

The device has a built-in temperature sensor which monitors the internal IC junction temperature. If the temperature exceeds the programmed threshold (see electrical characteristics table), the device stops operating. As soon as the IC temperature has decreased below the programmed threshold, it starts operating again. To prevent unstable operation close to the region of overtemperature threshold, a built-in hysteresis is implemented.

APPLICATION INFORMATION

DESIGN PROCEDURE

The TPS61222 DC/DC converter is intended for systems powered by a single cell battery to up to three Alkaline, NiCd or NiMH cells with a typical terminal voltage between 0.7 V and 5.5 V. It can also be used in systems powered by one-cell Li-Ion or Li-Polymer batteries with a typical voltage between 2.5 V and 4.2 V. Additionally, any other voltage source with a typical output voltage between 0.7 V and 5.5 V can be used with the TPS61222.

Programming the Output Voltage

Output voltage

The output voltage is set by a resistor divider internally. The FB pin is used to sense the output voltage. To configure the fixed output devices properly, the FB pin needs to be connected directly to VOUT as shown in [Figure 10](#).

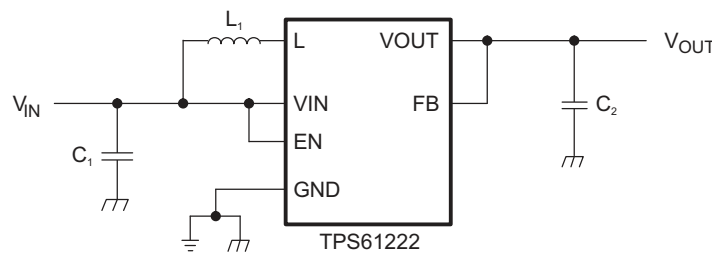

Figure 10. Typical Application Circuit

Inductor Selection

To make sure that the TPS61222 can operate, a suitable inductor must be connected between pin VIN and pin L. Inductor values of 4.7 μH show good performance over the whole input and output voltage range .

Choosing other inductance values affects the switching frequency f proportional to $1/L$ as shown in [Equation 1](#).

$$L = \frac{1}{f \times 200 \text{ mA}} \times \frac{V_{\text{IN}} \times (V_{\text{OUT}} - V_{\text{IN}})}{V_{\text{OUT}}} \quad (1)$$

Choosing inductor values higher than 4.7 μH can improve efficiency due to reduced switching frequency and therefore with reduced switching losses. Using inductor values below 2.2 μH is not recommended.

Having selected an inductance value, the peak current for the inductor in steady state operation can be calculated. [Equation 2](#) gives the peak current estimate.

$$I_{L,\text{MAX}} = \begin{cases} \frac{V_{\text{OUT}} \times I_{\text{OUT}}}{0.8 \times V_{\text{IN}}} + 100 \text{ mA}; & \text{continuous current operation} \\ 200 \text{ mA}; & \text{discontinuous current operation} \end{cases} \quad (2)$$

For selecting the inductor this would be the suitable value for the current rating. It also needs to be taken into account that load transients and error conditions may cause higher inductor currents.

[Equation 3](#) provides an easy way to estimate whether the device will work in continuous or discontinuous operation depending on the operating points. As long as the inequation is true, continuous operation is typically established. If the inequation becomes false, discontinuous operation is typically established.

$$\frac{V_{\text{OUT}} \times I_{\text{OUT}}}{V_{\text{IN}}} > 0.8 \times 100 \text{ mA} \quad (3)$$

The following inductor series from different suppliers have been used with TPS61222 converters:

Table 2. List of Inductors⁽¹⁾

VENDOR	INDUCTOR SERIES
Coilcraft	EPL3015
	EPL2010
Murata	LQH3NP
Tajo Yuden	NR3015
Würth Elektronik	WE-TPC Typ S

(1) Design was tested using these components at 25°C ambient temperature.

Capacitor Selection

Input Capacitor

At least a 10-μF input capacitor is recommended to improve transient behavior of the regulator and EMI behavior of the total power supply circuit. A ceramic capacitor placed as close as possible to the VIN and GND pins of the IC is recommended.

Output Capacitor

For the output capacitor C_2 , it is recommended to use small ceramic capacitors placed as close as possible to the VOUT and GND pins of the IC. If, for any reason, the application requires the use of large capacitors which can not be placed close to the IC, the use of a small ceramic capacitor with a capacitance value of around 2.2μF in parallel to the large one is recommended. This small capacitor should be placed as close as possible to the VOUT and GND pins of the IC.

A minimum capacitance value of 4.7 μF should be used, 10 μF are recommended. If the inductor value exceeds 4.7 μH, the value of the output capacitance value needs to be half the inductance value or higher for stability reasons, see [Equation 4](#).

$$C_2 \geq \frac{L}{2} \times \frac{\mu\text{F}}{\mu\text{H}} \quad (4)$$

The TPS61222 is not sensitive to the ESR in terms of stability. Using low ESR capacitors, such as ceramic capacitors, is recommended anyway to minimize output voltage ripple. If heavy load changes are expected, the output capacitor value should be increased to avoid output voltage drops during fast load transients.

Layout Considerations

As for all switching power supplies, the layout is an important step in the design, especially at high peak currents and high switching frequencies. If the layout is not carefully done, the regulator could show stability problems as well as EMI problems. Therefore, use wide and short traces for the main current path and for the power ground paths. The input and output capacitor, as well as the inductor should be placed as close as possible to the IC.

The feedback divider should be placed as close as possible to the control ground pin of the IC. To lay out the ground, it is recommended to use short traces as well, separated from the power ground traces. This avoids ground shift problems, which can occur due to superimposition of power ground current and control ground current. Assure that the ground traces are connected close to the device GND pin.

THERMAL INFORMATION

Implementation of integrated circuits in low-profile and fine-pitch surface-mount packages typically requires special attention to power dissipation. Many system-dependent issues such as thermal coupling, airflow, added heat sinks and convection surfaces, and the presence of other heat-generating components affect the power-dissipation limits of a given component.

Three basic approaches for enhancing thermal performance are listed below.

- Improving the power-dissipation capability of the PCB design
- Improving the thermal coupling of the component to the PCB
- Introducing airflow in the system

For more details on how to use the thermal parameters in the dissipation ratings table please check the [Thermal Characteristics Application Note \(SZZA017\)](#) and the [IC Package Thermal Metrics Application Note \(SPRA953\)](#).

PACKAGING INFORMATION

Orderable Device	Status (1)	Package Type	Package Drawing	Pins	Package Qty	Eco Plan (2)	Lead finish/ Ball material (6)	MSL Peak Temp (3)	Op Temp (°C)	Device Marking (4/5)	Samples
TPS61222MDCKTEP	ACTIVE	SC70	DCK	6	250	RoHS & Green	NIPDAU	Level-1-260C-UNLIM	-55 to 125	SHL	Samples
V62/12603-01XE	ACTIVE	SC70	DCK	6	250	RoHS & Green	NIPDAU	Level-1-260C-UNLIM	-55 to 125	SHL	Samples

(1) The marketing status values are defined as follows:

ACTIVE: Product device recommended for new designs.

LIFEBUY: TI has announced that the device will be discontinued, and a lifetime-buy period is in effect.

NRND: Not recommended for new designs. Device is in production to support existing customers, but TI does not recommend using this part in a new design.

PREVIEW: Device has been announced but is not in production. Samples may or may not be available.

OBSOLETE: TI has discontinued the production of the device.

(2) **RoHS:** TI defines "RoHS" to mean semiconductor products that are compliant with the current EU RoHS requirements for all 10 RoHS substances, including the requirement that RoHS substance do not exceed 0.1% by weight in homogeneous materials. Where designed to be soldered at high temperatures, "RoHS" products are suitable for use in specified lead-free processes. TI may reference these types of products as "Pb-Free".

RoHS Exempt: TI defines "RoHS Exempt" to mean products that contain lead but are compliant with EU RoHS pursuant to a specific EU RoHS exemption.

Green: TI defines "Green" to mean the content of Chlorine (Cl) and Bromine (Br) based flame retardants meet JS709B low halogen requirements of <=1000ppm threshold. Antimony trioxide based flame retardants must also meet the <=1000ppm threshold requirement.

(3) MSL, Peak Temp. - The Moisture Sensitivity Level rating according to the JEDEC industry standard classifications, and peak solder temperature.

(4) There may be additional marking, which relates to the logo, the lot trace code information, or the environmental category on the device.

(5) Multiple Device Markings will be inside parentheses. Only one Device Marking contained in parentheses and separated by a "~" will appear on a device. If a line is indented then it is a continuation of the previous line and the two combined represent the entire Device Marking for that device.

(6) Lead finish/Ball material - Orderable Devices may have multiple material finish options. Finish options are separated by a vertical ruled line. Lead finish/Ball material values may wrap to two lines if the finish value exceeds the maximum column width.

Important Information and Disclaimer:The information provided on this page represents TI's knowledge and belief as of the date that it is provided. TI bases its knowledge and belief on information provided by third parties, and makes no representation or warranty as to the accuracy of such information. Efforts are underway to better integrate information from third parties. TI has taken and continues to take reasonable steps to provide representative and accurate information but may not have conducted destructive testing or chemical analysis on incoming materials and chemicals. TI and TI suppliers consider certain information to be proprietary, and thus CAS numbers and other limited information may not be available for release.

In no event shall TI's liability arising out of such information exceed the total purchase price of the TI part(s) at issue in this document sold by TI to Customer on an annual basis.

OTHER QUALIFIED VERSIONS OF TPS61222-EP :

- Catalog: [TPS61222](#)

NOTE: Qualified Version Definitions:

- Catalog - TI's standard catalog product

TAPE AND REEL INFORMATION

QUADRANT ASSIGNMENTS FOR PIN 1 ORIENTATION IN TAPE

*All dimensions are nominal

Device	Package Type	Package Drawing	Pins	SPQ	Reel Diameter (mm)	Reel Width W1 (mm)	A0 (mm)	B0 (mm)	K0 (mm)	P1 (mm)	W (mm)	Pin1 Quadrant
TPS61222MDCKTEP	SC70	DCK	6	250	178.0	8.4	2.4	2.5	1.2	4.0	8.0	Q3

TAPE AND REEL BOX DIMENSIONS



*All dimensions are nominal

Device	Package Type	Package Drawing	Pins	SPQ	Length (mm)	Width (mm)	Height (mm)
TPS61222MDCKTEP	SC70	DCK	6	250	180.0	180.0	18.0

DCK (R-PDSO-G6)

PLASTIC SMALL-OUTLINE PACKAGE

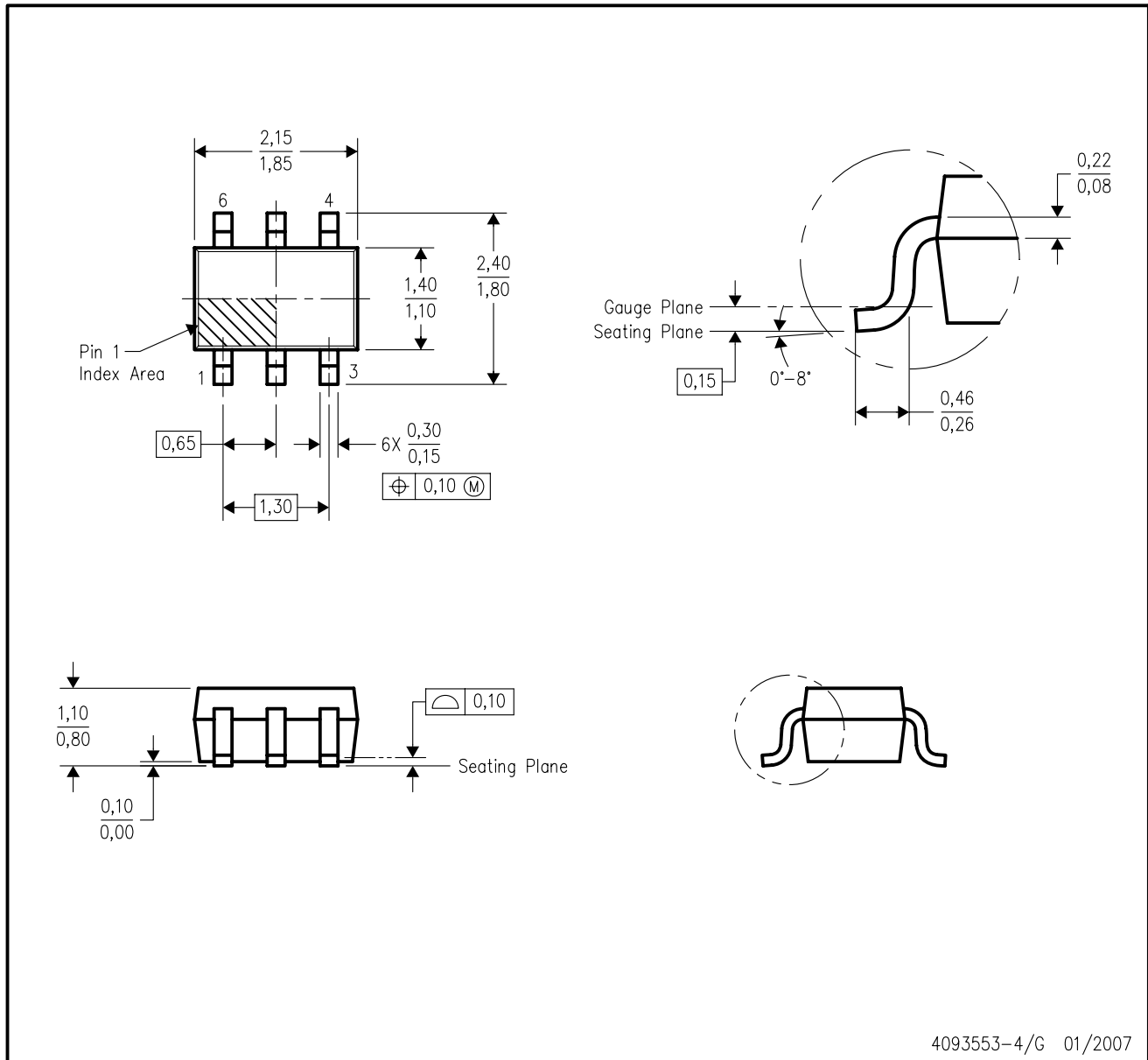

- NOTES:
- A. All linear dimensions are in millimeters.
 - B. This drawing is subject to change without notice.
 - C. Body dimensions do not include mold flash or protrusion. Mold flash and protrusion shall not exceed 0.15 per side.
 - D. Falls within JEDEC MO-203 variation AB.

DCK (R-PDSO-G6)

PLASTIC SMALL OUTLINE

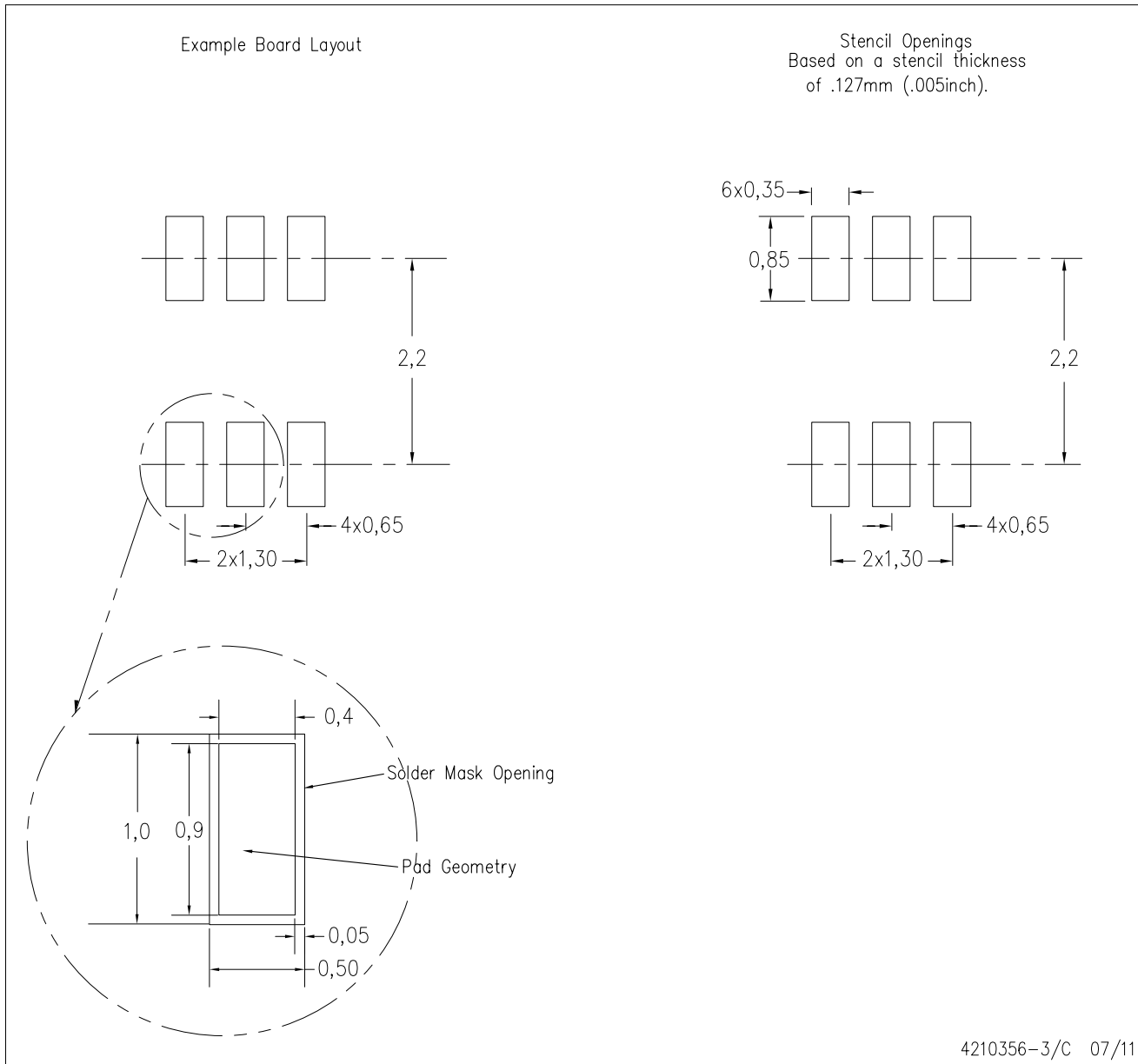

- NOTES:
- All linear dimensions are in millimeters.
 - This drawing is subject to change without notice.
 - Customers should place a note on the circuit board fabrication drawing not to alter the center solder mask defined pad.
 - Publication IPC-7351 is recommended for alternate designs.
 - Laser cutting apertures with trapezoidal walls and also rounding corners will offer better paste release. Customers should contact their board assembly site for stencil design recommendations. Example stencil design based on a 50% volumetric metal load solder paste. Refer to IPC-7525 for other stencil recommendations.

IMPORTANT NOTICE AND DISCLAIMER

TI PROVIDES TECHNICAL AND RELIABILITY DATA (INCLUDING DATASHEETS), DESIGN RESOURCES (INCLUDING REFERENCE DESIGNS), APPLICATION OR OTHER DESIGN ADVICE, WEB TOOLS, SAFETY INFORMATION, AND OTHER RESOURCES "AS IS" AND WITH ALL FAULTS, AND DISCLAIMS ALL WARRANTIES, EXPRESS AND IMPLIED, INCLUDING WITHOUT LIMITATION ANY IMPLIED WARRANTIES OF MERCHANTABILITY, FITNESS FOR A PARTICULAR PURPOSE OR NON-INFRINGEMENT OF THIRD PARTY INTELLECTUAL PROPERTY RIGHTS.

These resources are intended for skilled developers designing with TI products. You are solely responsible for (1) selecting the appropriate TI products for your application, (2) designing, validating and testing your application, and (3) ensuring your application meets applicable standards, and any other safety, security, or other requirements. These resources are subject to change without notice. TI grants you permission to use these resources only for development of an application that uses the TI products described in the resource. Other reproduction and display of these resources is prohibited. No license is granted to any other TI intellectual property right or to any third party intellectual property right. TI disclaims responsibility for, and you will fully indemnify TI and its representatives against, any claims, damages, costs, losses, and liabilities arising out of your use of these resources.

TI's products are provided subject to TI's Terms of Sale (www.ti.com/legal/termsofsale.html) or other applicable terms available either on ti.com or provided in conjunction with such TI products. TI's provision of these resources does not expand or otherwise alter TI's applicable warranties or warranty disclaimers for TI products.

Mailing Address: Texas Instruments, Post Office Box 655303, Dallas, Texas 75265
Copyright © 2020, Texas Instruments Incorporated