

Specification

- Part No. : **G20.B.305111.wmc**
- Product Name : Hercules Covert Wall and Cabinet Mounted Cellular Antenna
- Features : 850/900/1700/1800/1900/2100 MHz
High Efficiency - Omni-directional Pattern
Covert and Vandal Resistant
Standard is 3m Cable NFC200 SMA(M)-Customizable
IP65 Rated Enclosure
RoHS & REACH Compliant



1. Introduction

The Wall Mount G20 Hercules Gen II is a high performance covert wall mounted cellular antenna for 2G and 3G applications. This antenna can easily fix to a wall or metal surface. The Wall Mount G20 antenna has omnidirectional radiation patterns across all bands ensuring constant reception and transmission.

Applications

- Smart City Outdoors Utility and Traffic Management

 - On Building Wall

 - On Street Metal Cabinet

PC housing is IP65 rated, resistant to vandalism and direct attack. The bracket allows complete concealment of the cable for a more secure integration and cleaner installation. The cable can also be routed out of the back wall of the bracket into the interior of the mounting wall for added security against vandalism. The standard version comes with 3 meters extremely low loss NFC200 (0.3dB against 0.7dB per meter for RG58) to allow for flexibility of placement. The cable and connector can be completely customized.

2. Specification

ELECTRICAL					
Standard	GSM	GSM	DCS	PCS	UMTS/ HSPA
Band (MHz)	850	900	1800	1900	2100
Frequency (MHz)	824~894	880~960	1710~1880	1850~1990	1920~2170
Efficiency (%)					
30 cm cable length	45.64	70.44	75.09	63.10	54.48
1 meter cable length	43.59	67.27	68.48	57.80	50.15
2 meters cable length	40.32	61.35	61.56	51.51	44.54
3 meters cable length	37.33	56.84	54.40	45.24	38.97
5 meters cable length	32.05	53.61	50.65	40.64	33.64
Average Gain(dBi)					
30 cm cable length	-3.68	-1.53	-1.27	-2.04	-2.76
1 meter cable length	-3.88	-1.73	-1.67	-2.41	-3.12
2 meters cable length	-4.21	-2.13	-2.14	-2.91	-3.64
3 meters cable length	-4.54	-2.47	-2.67	-3.48	-4.22
5 meters cable length	-5.28	-3.23	-3.75	-4.60	-5.33
Peak Gain(dBi)					
30 cm cable length	2.07	3.21	4.21	3.48	2.81
1 meter cable length	1.87	3.01	3.81	3.10	2.45
2 meters cable length	1.54	2.61	3.34	2.60	1.93
3 meters cable length	1.21	2.28	2.81	2.04	1.35
5 meters cable length	0.47	1.51	1.73	0.92	0.24
Impedance	50Ω				
Polarization	Linear				
Radiation Pattern	Omni				
Input Power	5 W				
MECHANICAL					
Antenna Dimensions	Height = 29 mm and Diameter = 49 mm				
Bracket Dimensions	Height = 92.4 mm and Length = 128.7 mm				
Antenna Cable Length	3M NFC200 – Fully Customizable				
Connector	SMA-Male – Fully Customizable				
Antenna Casing	PC				
Bracket Casing	Plastic: PC+ABS, Metal: Aluminum				
Base and Thread	Nickel plated steel				
Thread Diameter	18 mm				
Weather proof gasket	CR4305 foam with 3M9448B double-sided adhesive				
Sealant	Rubber Stopper				
Weight	340g				
ENVIRONMENTAL					
Corrosion	5% NaCl for 48hrs - Nickel plated steel base and thread				
Temperature Range	-40°C to +85°C				
Thermal Shock	100 cycles -40°C to +85°C				
Humidity	Non-condensing 65°C 95% RH				
Shock (Drop Test)	1m drop on concrete 6 axes				
Ingress Protection	IP65				

3. Antenna Characteristics

3.1 Testing setup



Figure.1 Test setup with bracket

3.2 Return loss

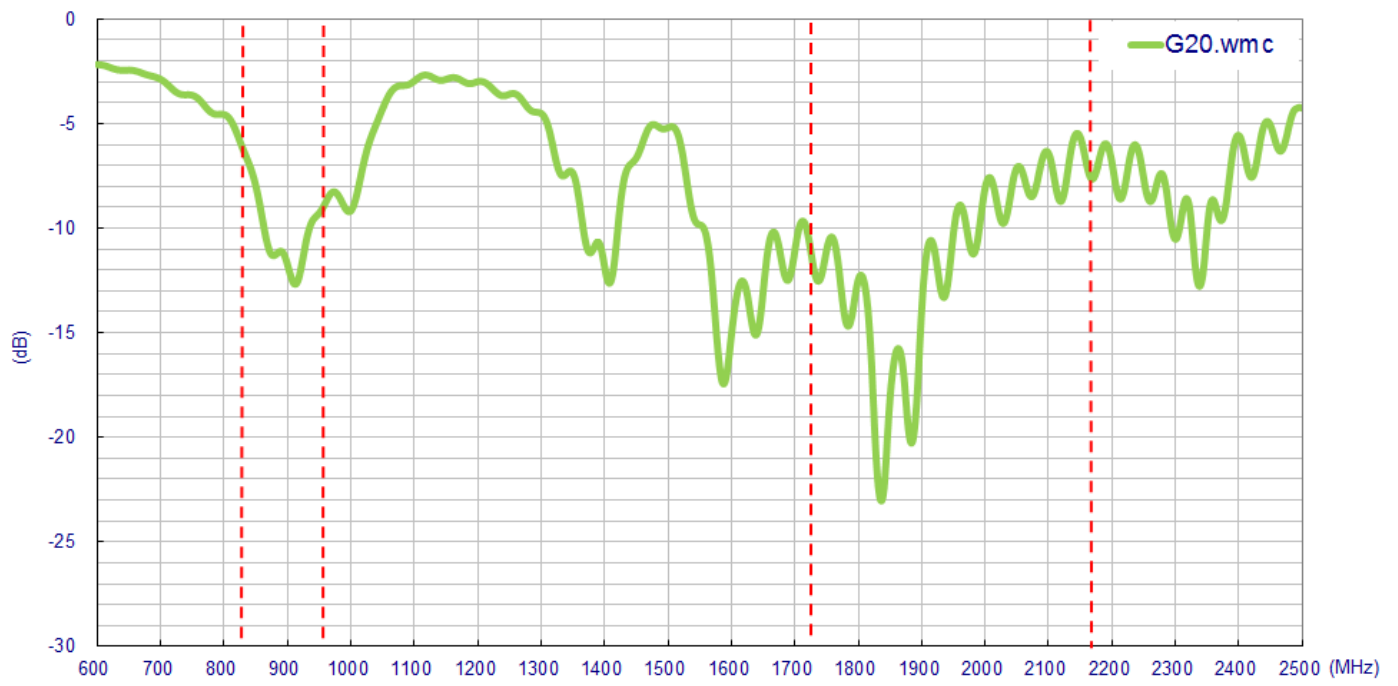


Figure2. Return loss of G20.B.305111.wmc with 3 meters cable length

3.3 Efficiency

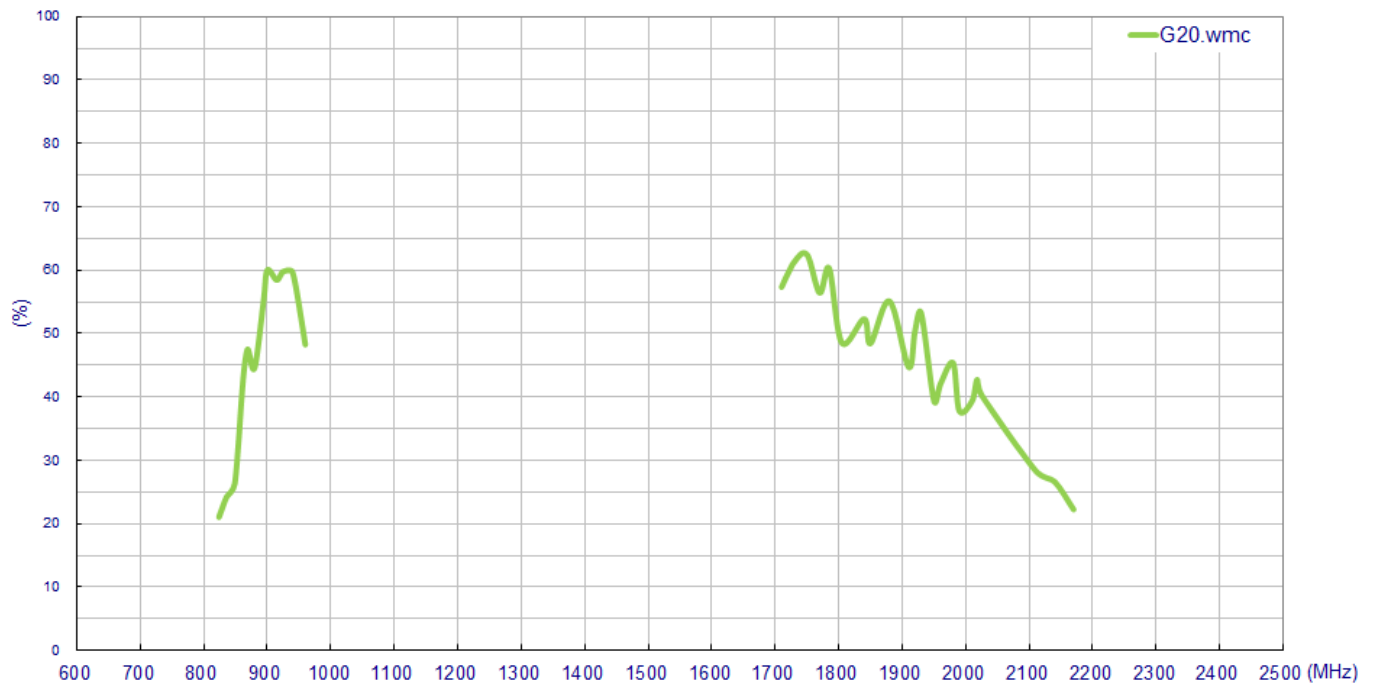


Figure3. Efficiency of G20.B.305111.wmc with 3 meters cable length

3.4 Peak gain

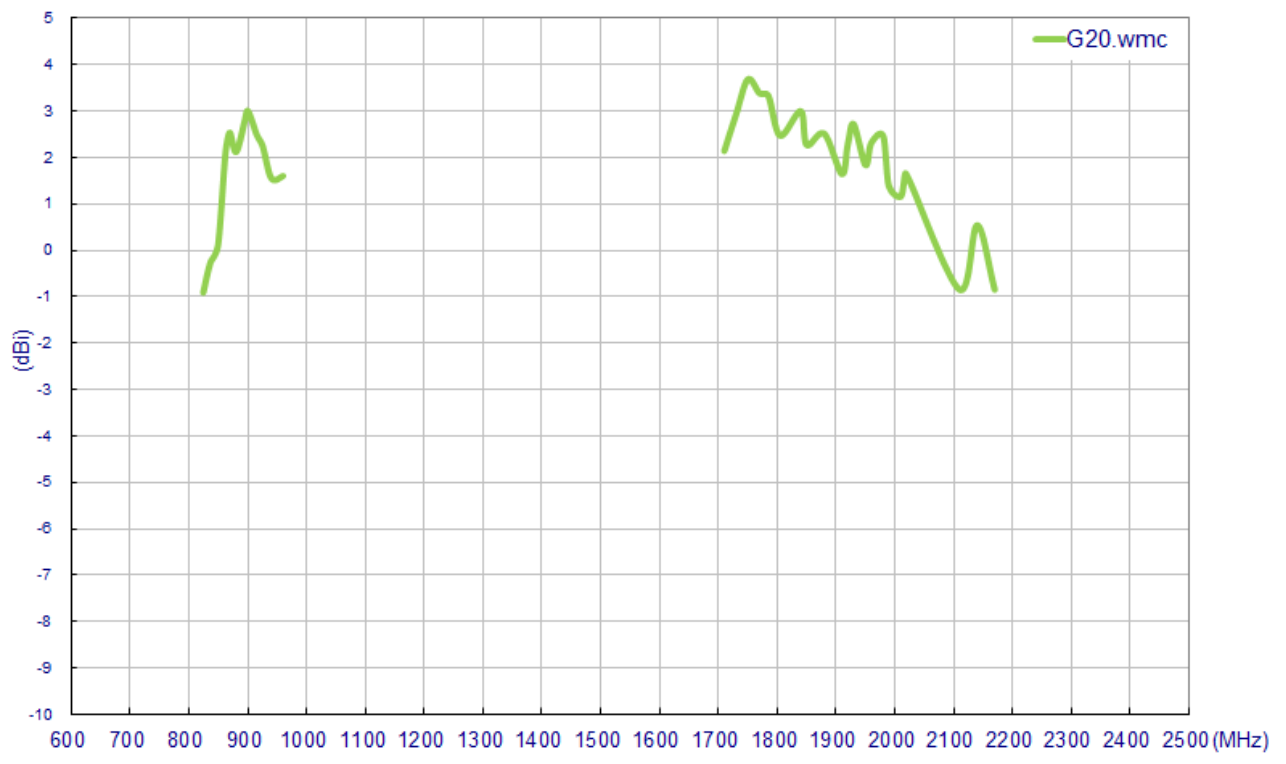


Figure4. Peak gain of G20.B.305111.wmc with 3 meters cable length

3.5 Average gain

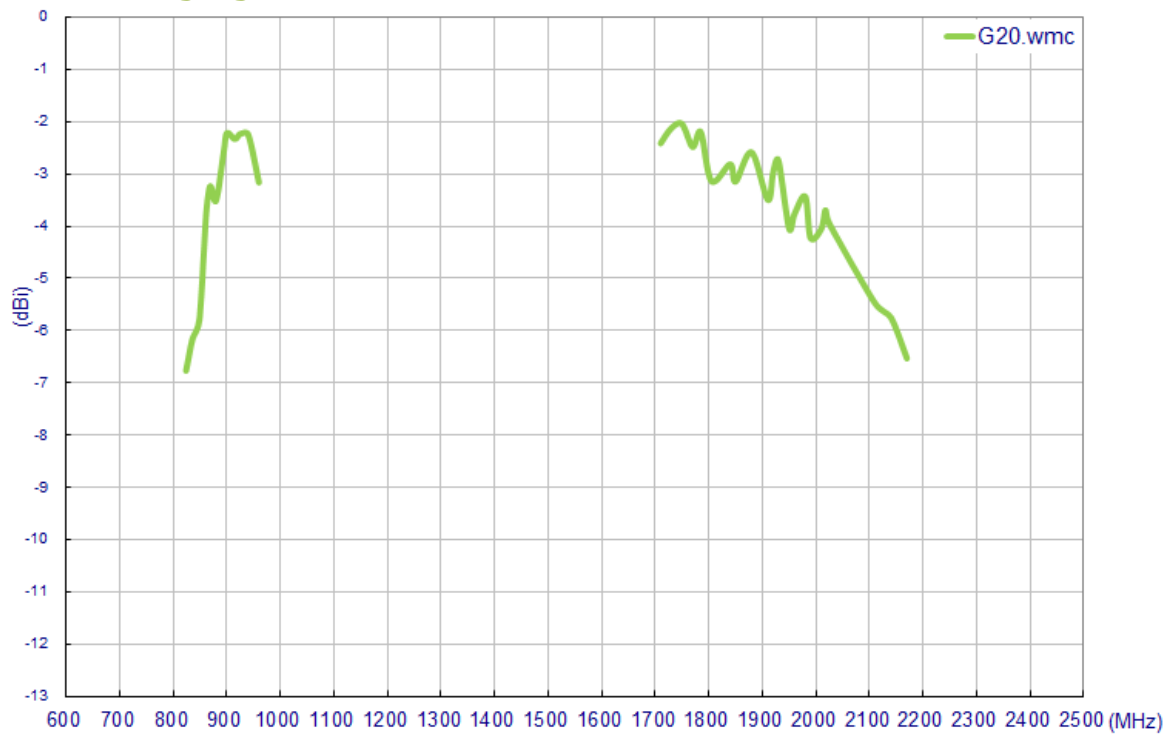


Figure5. Average gain of G20.B.305111.wmc with 3 meters cable length

4. Antenna Radiation Patterns

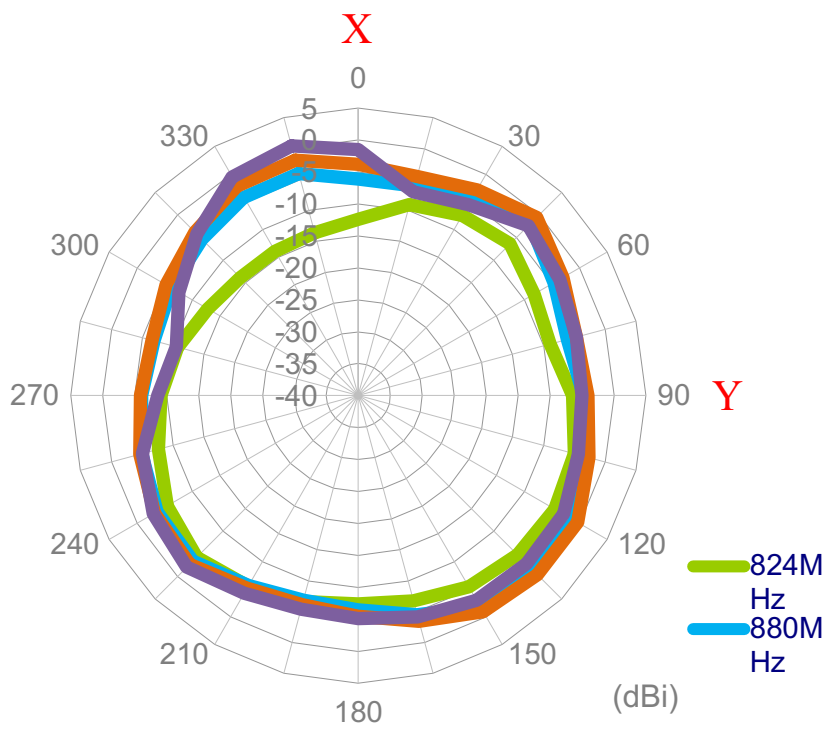
4.1 Testing setup

The antenna radiation patterns were measured in ETS Anechoic Chamber. The measurement setup as below,

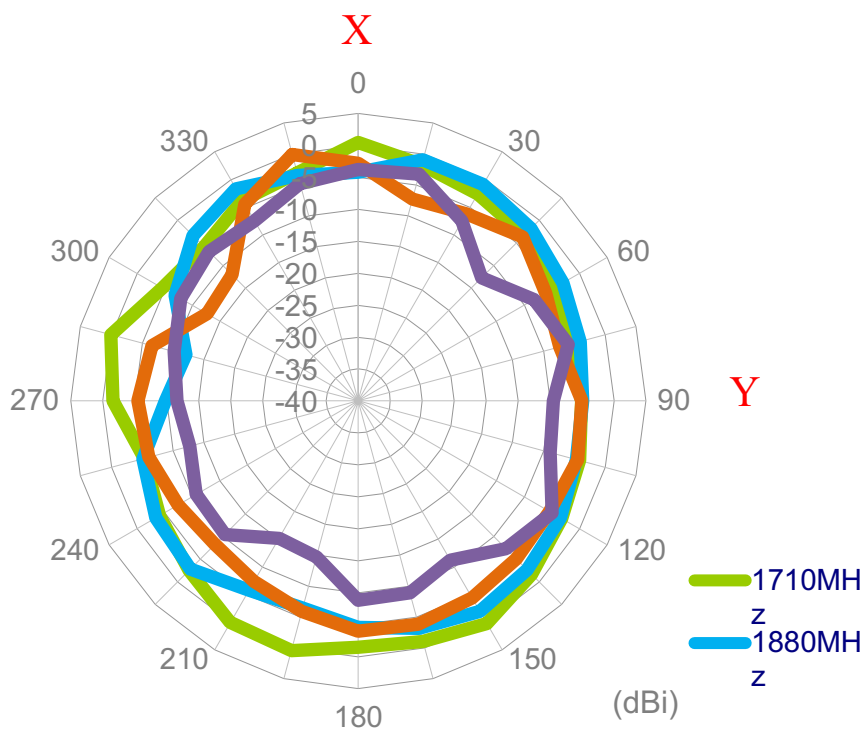


Figure.6 Testing Setup in ETS Anechoic Chamber

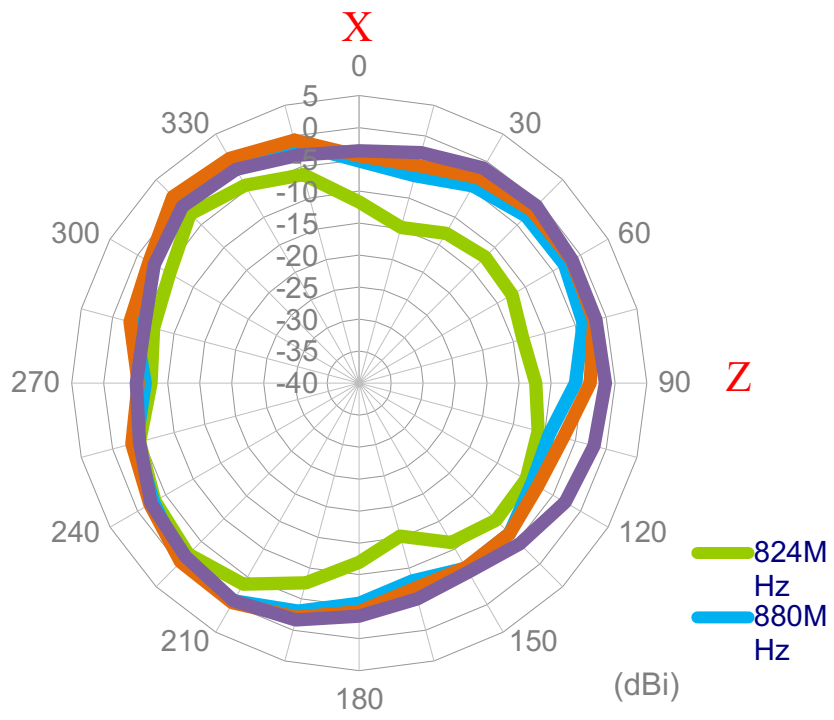
4.2 Antenna radiation patterns (Antenna with L-bracket and 3 meters cable length)
X-Y plane (824MHz~960MHz)



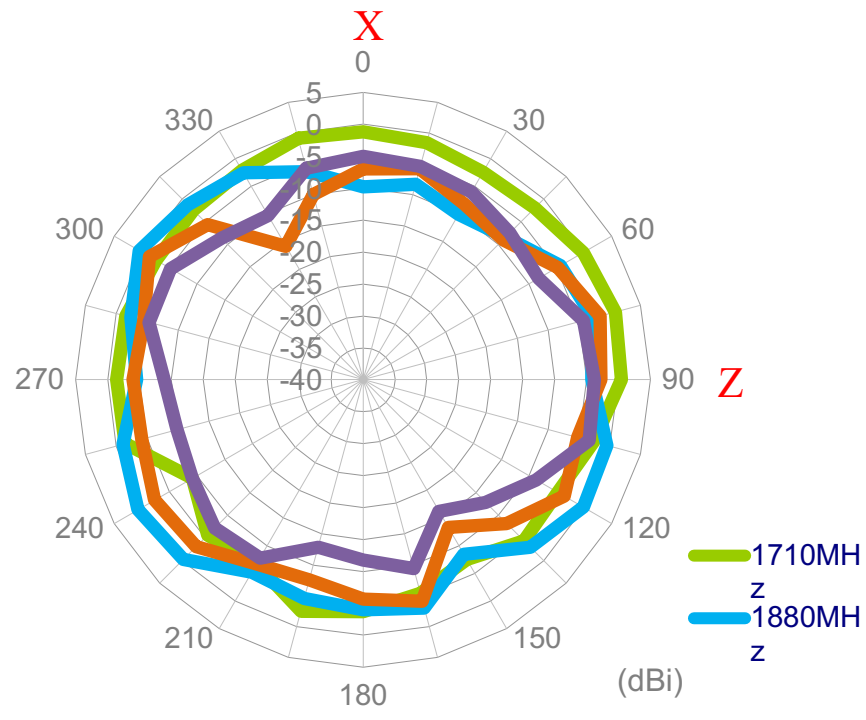
X-Y plane (1710MHz~2170MHz)



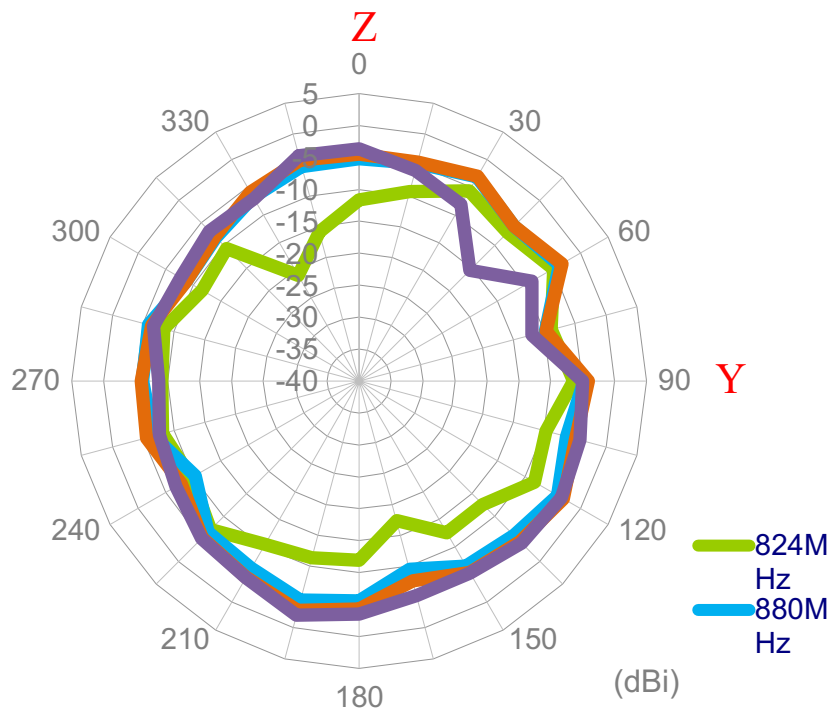
X-Z plane (824MHz~960MHz)



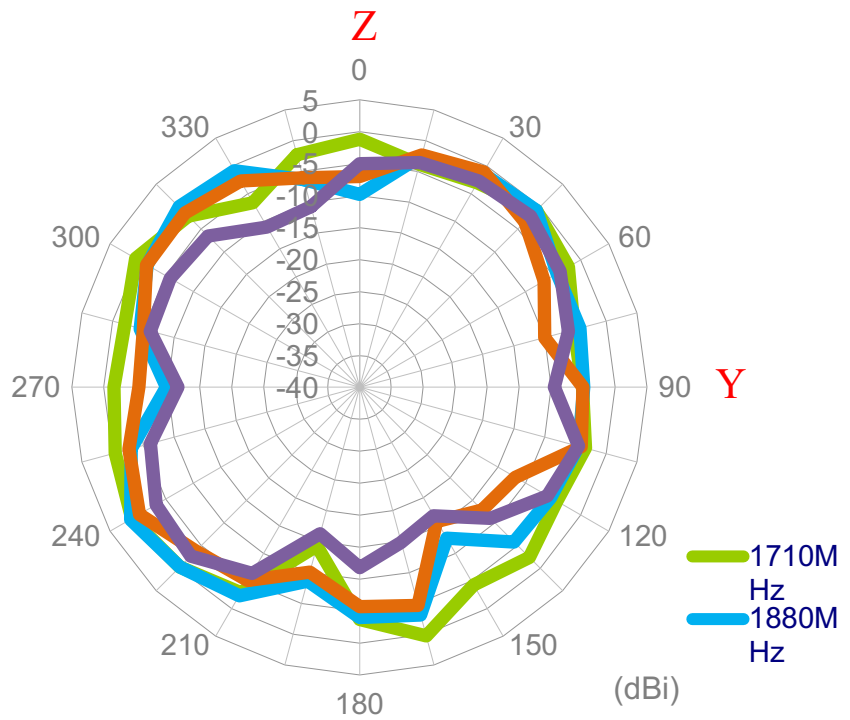
X-Z plane (1710MHz~2170MHz)



Y-Z plane (824MHz~960MHz)

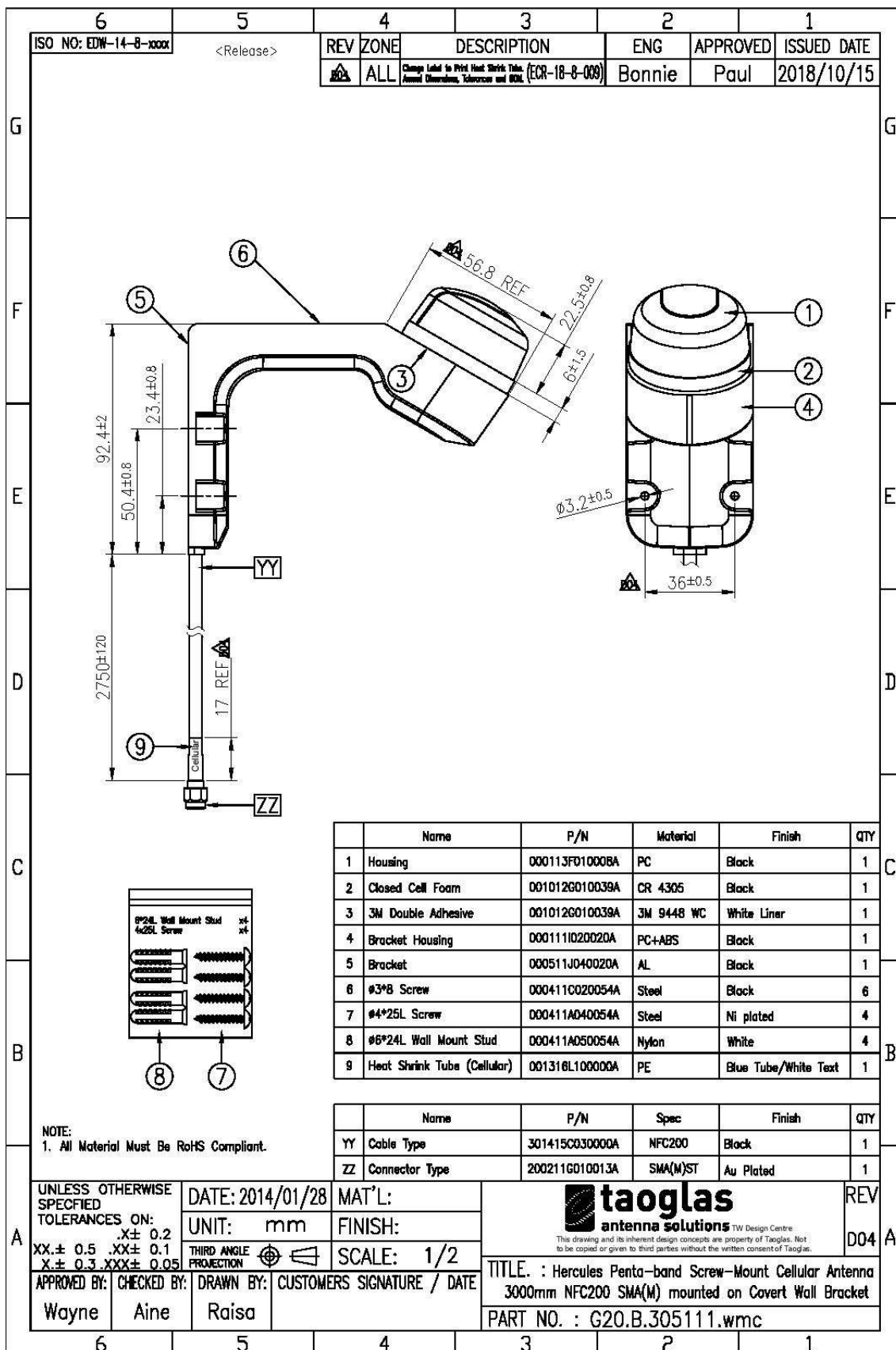


Y-Z plane (1710MHz~2170MHz)

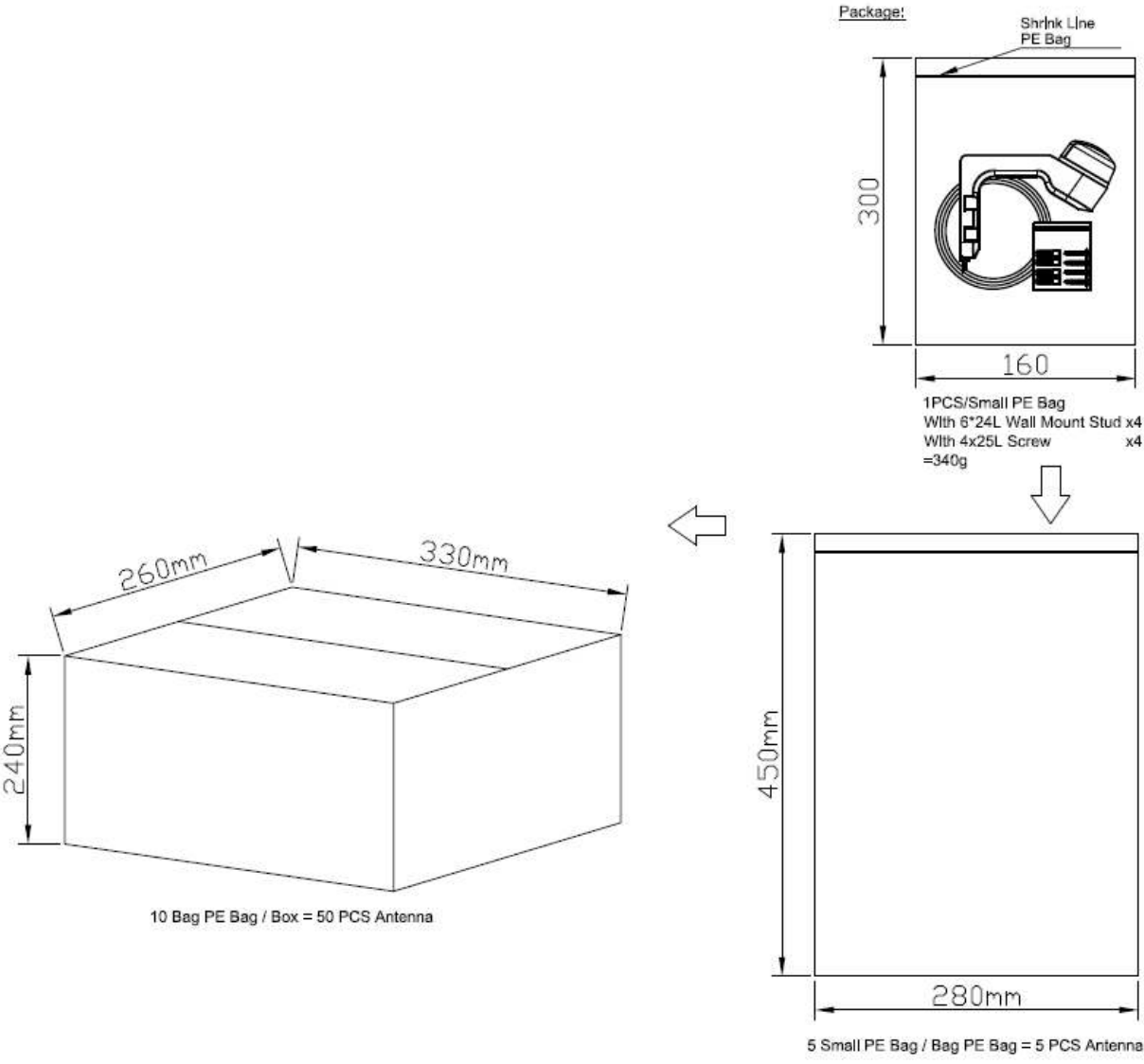




5. Drawing



6. Packaging



7. Application Note

The G20.B.305111.wmc antenna measurement with different cable length, the performance is shown as below:

7.1 Return loss

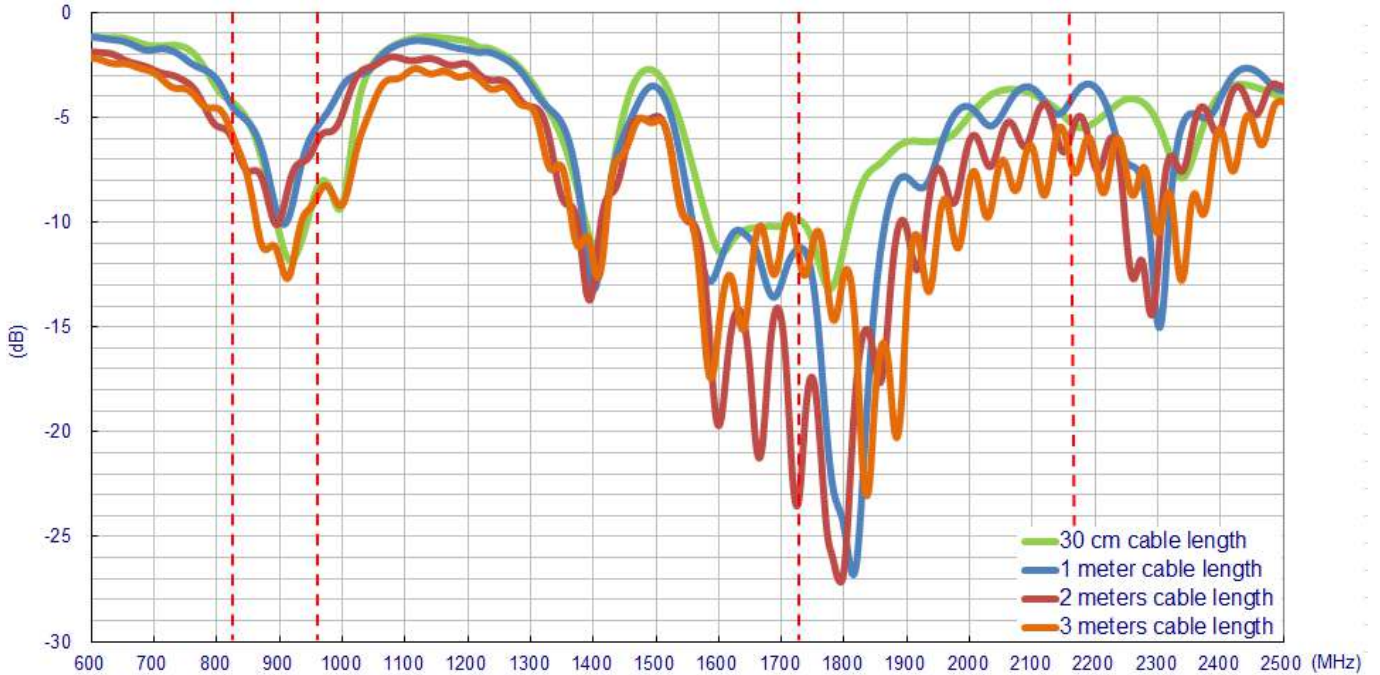


Figure 7. Measured the return loss of G20.B.305111.wmc Antenna with different cable length

7.2 Efficiency

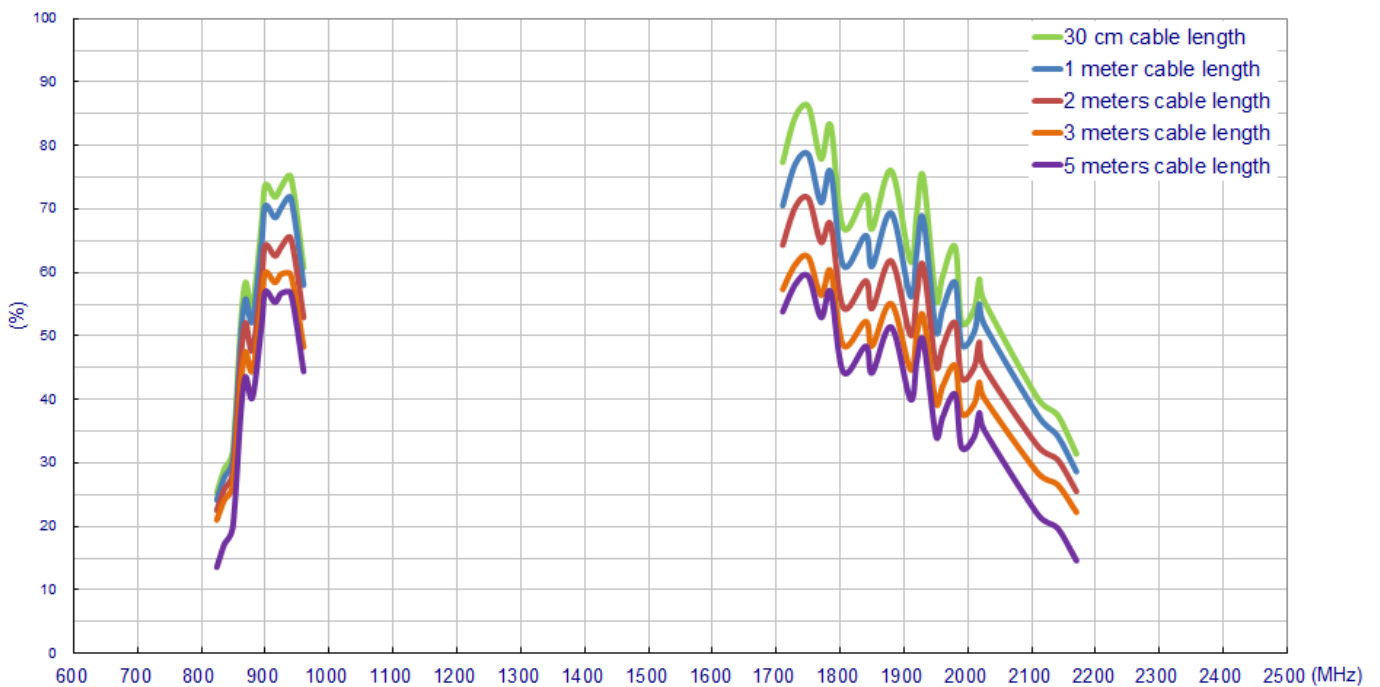


Figure 8. Measured the efficiency of G20.B.305111.wmc Antenna with different cable length

7.3 Average Gain

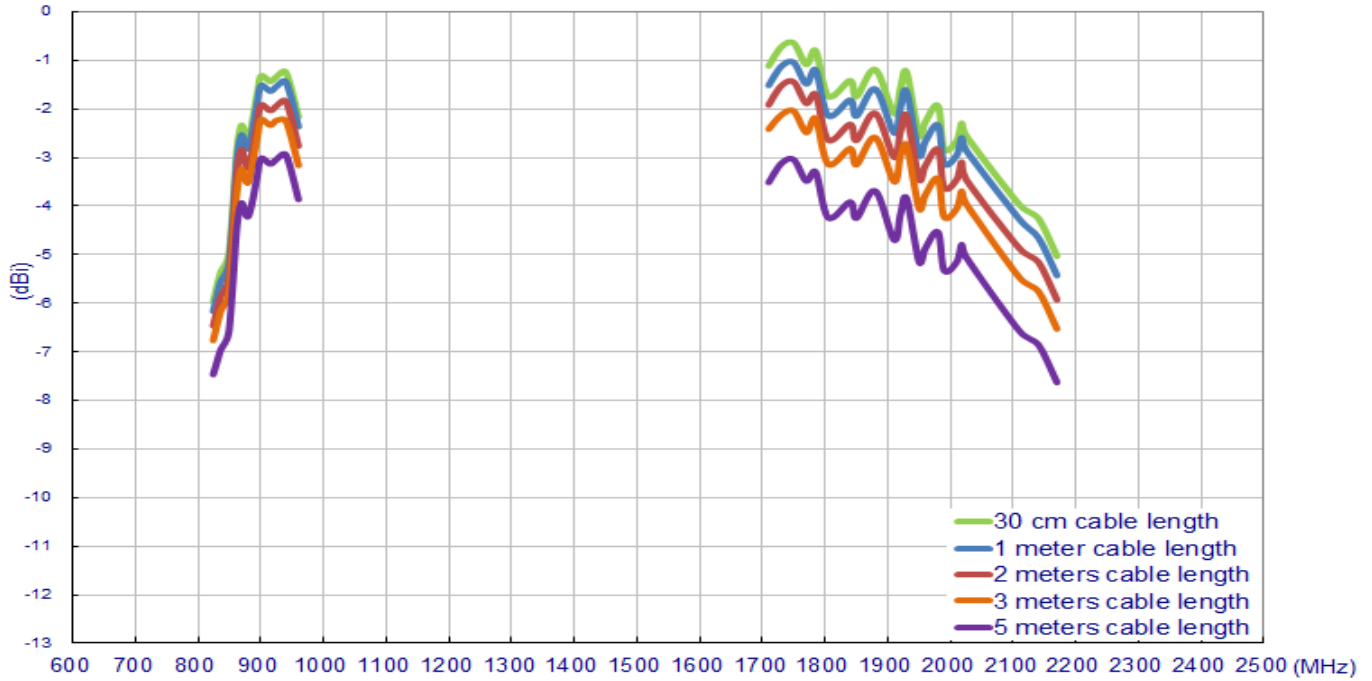


Figure 9. Measured the Average Gain of G20.B.305111.wmc Antenna with different cable length

7.4 Peak Gain

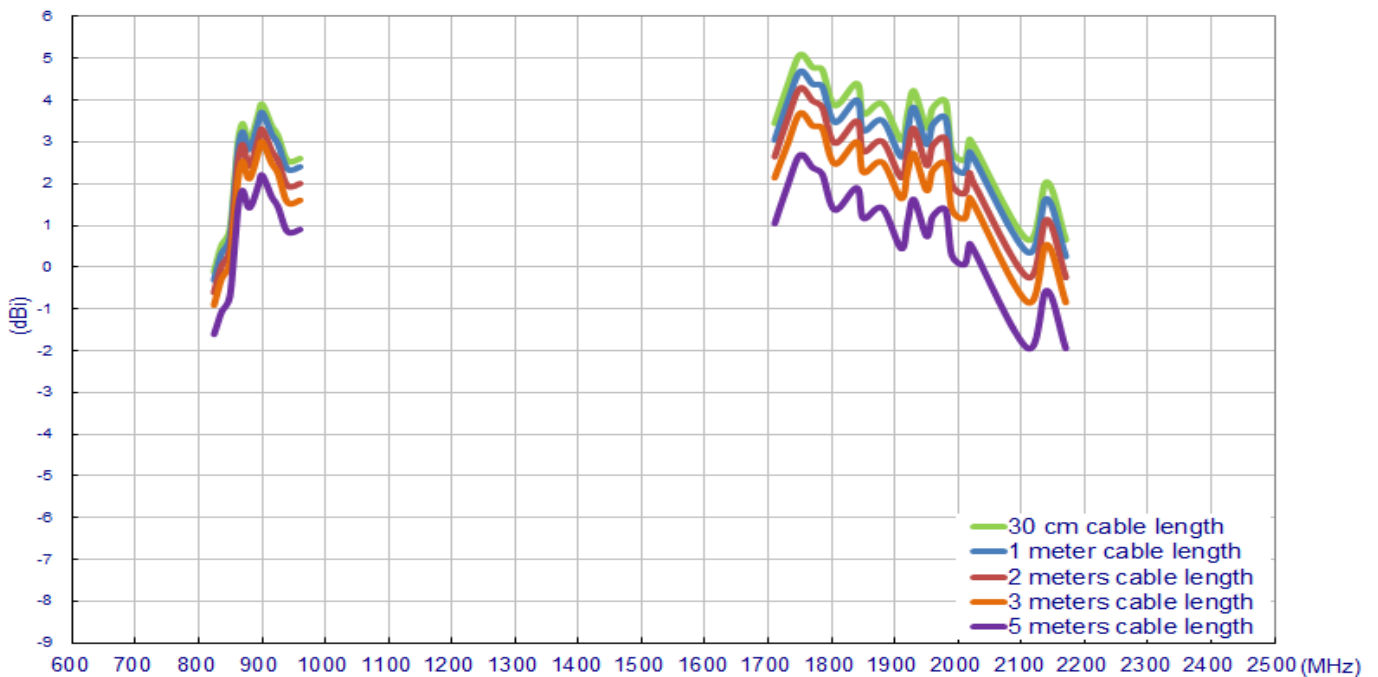


Figure 10. Measured the Peak Gain of G20.B.305111.wmc Antenna with different cable length

Taoglas makes no warranties based on the accuracy or completeness of the contents of this document and reserves the right to make changes to specifications and product descriptions at any time without notice. Taoglas reserves all rights to this document and the information contained herein.

Reproduction, use or disclosure to third parties without express permission is strictly prohibited.

© Taoglas