



Pro Micro & Fio v3 Hookup Guide

CONTRIBUTORS:  JIMBO

Introduction

Welcome to the new frontier of Arduino-compatible boards, made possible by the ATmega32U4. No longer does your Arduino need to be harnessed by an FTDI Cable, or an ATmega8U2, or any chip whose sole purpose is acting as an intermediary between your Arduino and your computer.

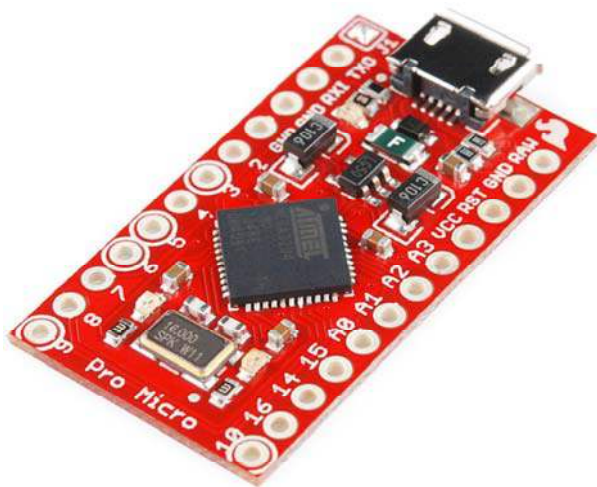

The SparkFun Pro Micro is a really cool, little development board. It's an Arduino-compatible microcontroller, micro-sized, and it accomplishes with one single chip what old Arduino Unos, Duemilanoves, and Diecimeillas could never dream of: true USB functionality.

This tutorial also covers the Fio v3, which works a lot like the Pro Micro but adds features like easy XBee interfacing and LiPo charging.

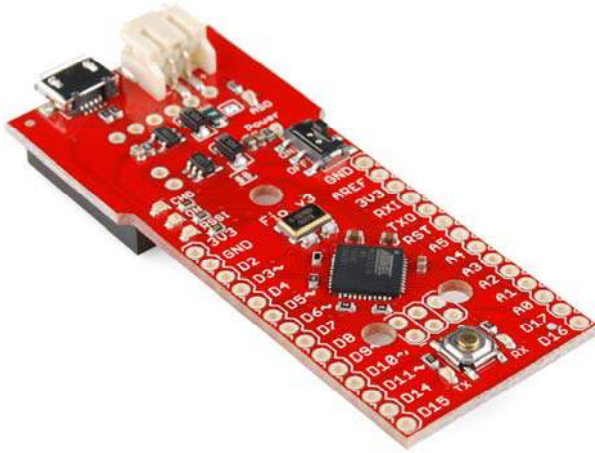

Covered In This Tutorial

This tutorial aims to introduce you to both the hardware and firmware sides of the Pro Micro (and Fio v3). We'll also dedicate a few pages to helping install the boards on Windows and Mac. Here's a summary of what will be covered:

- **Hardware Overview: Pro Micro** – An overview of the pinout and hardware features of the Pro Micro.
- **Hardware Overview: Fio v3** – An overview of the pinout and hardware features of the Fio v3.
- **Installing on Windows** – How to install the drivers and Arduino add-on on Windows.
- **Installing on Mac/Linux** – How to install the drivers and Arduino add-on on Mac.
- **Example 1: Blinkies** – A simple “Hello, world” sketch specifically suited to the Pro Micro and Fio v3.
- **Example 2: HID Mouse and Keyboard** – An introduction to the HID USB capability of the Pro Micro. How to emulate USB keyboards and mice!
- **Troubleshooting and FAQ** – Helpful troubleshooting tips and tricks for getting the most out of the Pro Micro.

Suggested Reading

Before delving into this tutorial, here are some concepts you should be familiar with. If you're not, consider checking out the related tutorial first.

- **What is Arduino?** – An introduction to the Arduino platform and IDE.
- **How to Install Arduino** – A general installation guide for Arduino.
- **Serial Communication** – Serial is a great, easy-to-use communication protocol.

Hardware Overview: Pro Micro

Before we get into installing and using the Pro Micro, let's quickly look at the board – examine its inputs, outputs, and other hardware quirks.

The Pinout

All of the Pro Micro's I/O and power pins are broken out to two, parallel headers. Some pins are for power input or output, other pins are dedicated I/O pins. Further, the I/O pins can have special abilities, like analog input. Here's a map of which pin is where, and what special hardware functions it may have:

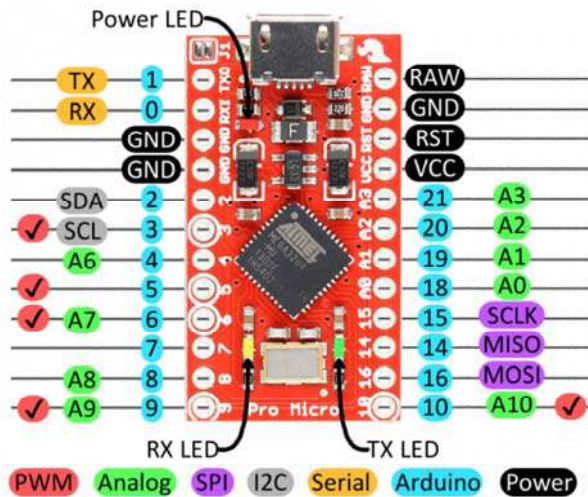

Delving a little further into which pins do what...

Power Pins

There are a variety of power and power-related nets broken out:

- **RAW** is the unregulated voltage input for the Pro Micro. If the board is powered via USB, the voltage at this pin will be about 4.8V (USB's 5V minus a schottkey diode drop). On the other hand, if the board is powered externally, through this pin, the applied voltage can be up to 12V.
- **VCC** is the voltage supplied to the on-board ATmega32U4. This voltage will depend on whether you're using a 3.3V/8MHz Pro Micro or a 5V/16MHz version, it'll be either 3.3V or 5V respectively. This voltage is **regulated** by the voltage applied to the RAW pin. If the board is powered through the 'RAW' pin (or USB), this pin can be used as an **output** to supply other devices.
- **RST** can be used to **restart** the Pro Micro. This pin is pulled high by a 10k Ω resistor on the board, and is **active-low**, so it must be connected to ground to initiate a reset. The Pro Micro will remain "off" until the reset line is pulled back to high.
- **GND**, of course, is the common, ground voltage (0V reference) for the system.

I/O Pins

The Pro Micro's I/O pins – 18 in all – are multi-talented. Every pin can be used as a **digital input or output**, for blinking LEDs or reading button presses. These pins are referenced in the Arduino IDE via an integer value between 0 and 21. (The A0-A3 pins can be referenced digitally using either their analog or digital pin number).

Nine pins feature analog to digital converters (ADCs) and can be used as **analog inputs**. These are useful for reading potentiometers or other analog devices using the `analogRead([pin])` function.

There are five pins with pulse width modulation (PWM) functionality, which allows for a form of **analog output** using the `analogWrite([pin], [value])` function. These pins are indicated on-board with a faint, white circle around them.

There are hardware UART (serial), I²C, and SPI pins available as well. These can be used to interface with digital devices like serial LCDs, XBees, IMUs, and other serial sensors.

The Pro Micro has five external interrupts, which allow you to instantly trigger a function when a pin goes either high or low (or both). If you attach an interrupt to an interrupt-enabled pin, you'll need to know the specific interrupt that pin triggers: pin 3 maps to interrupt 0, pin 2 is interrupt 1, pin 0 is interrupt 2, pin 1 is interrupt 3, and pin 7 is interrupt 4.

On-Board LEDs

There are three LEDs on the Pro Micro. One red LED indicates whether **power** is present.

The other two LEDs help indicate when data is transferring over USB. A yellow LED represents USB data coming *into* (RX) the the Pro Micro, and a green LED indicates USB data going out (TX).

3.3V or 5V? 8MHz or 16MHz?

Pro Micros come in two flavors, which vary by system **voltage** and operating **frequency**. The standard 5V Pro Micro runs at 16MHz, and is very comparable to an Arduino Leonardo, while the 3.3V version of the Pro Micro runs at half the speed (to remain in the safe operating zone at the lower voltage) – 8MHz.

The operating voltage of your Pro Micro determines the maximum allowable voltage on any of the I/O pins. For example, if you have a 3.3V Pro Micro, don't interface it with something that outputs 5V.



Don't forget which version you have! We'll need to differentiate between the two when we get to uploading code in Arduino. If you're not sure which version you have, check the back corner of the board. One of two boxes should be checked to indicate the operating voltage.

How to Power the Pro Micro

As the Pro Micro's main feature is its innate USB functionality, the most common way to power it is via **USB**. In this setup, a 5V Pro Micro will be powered directly from the USB bus and a 3.3V Pro Micro will regulate the 5V supply coming in from USB down. The other end of the USB cable can be connected to either a computer, USB hub, or a USB wall adapter, which can (in most cases) provide more power.

Alternatively, if your Pro Micro is living out in the wild, out of reach of USB cables, it can be powered through either the 'RAW' or 'VCC' pins. A supply going into the '**RAW**' pin will be **regulated** down to the correct operating voltage (5V or 3.3V). To be safe, it shouldn't be any higher than 12V, and it should be at least 1V more than the Pro Micro's operating voltage (e.g. >6V for a 5V Pro Micro).



Pro Micro powered through the RAW pin by a set of four, series AA batteries.

If you power the Pro Micro through the '**VCC**' pin, keep in mind that this signal is **unregulated**. Only use this if you have a clean, regulated 3.3V or 5V supply to connect to it.

How, exactly, you power your project is up to you and the demands of your project. If you're making something battery powered, you may want to opt for the 3.3V Pro Micro, which could be powered by a LiPo battery or a couple alkalines.

Hardware Overview: Fio v3

On this page we'll examine the hardware half of the Fio v3, looking at the pinout, layout, and schematic of the board.

The Fio v3 is like an elongated Pro Micro. On one end, it's shape and pinouts are similar to it's ATmega32U4 sibling. The other end of the Fio v3 is what makes it unique: a footprint for an XBee on the bottom, and a LiPo charging circuit on the top.

The Pinout

All of the Fio v3's pins are broken out to either side of the board. Some pins are for power input or output, other pins are dedicated I/O pins. Further, the I/O pins can have special abilities, like analog input, or serial input/output. Here's a map of which pin is where, and what special capabilities it may have:

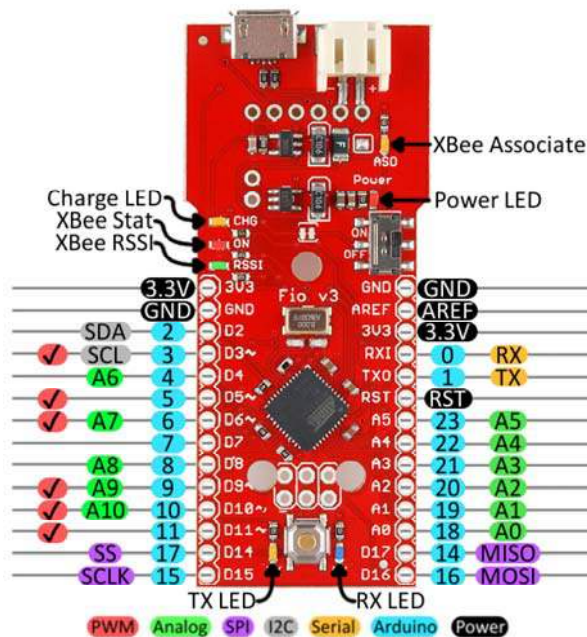

Power Pins

The pins labeled '3.3V' break out the operating voltage source of the ATmega32U4. As long as the board is powered through the white JST connector or USB, this voltage is **regulated** down to 3.3V. These pins can be used as **outputs** to supply 3.3V to other devices.

The '**RST**' pin can be used to **restart** the Fio. This pin is pulled high by a 10kΩ resistor on the board, and is **active-low**, so it must be connected to ground to initiate a reset. The Fio will remain off until the reset line is pulled back to high.

I/O Pins

Many of the Fio's I/O pins are multi-talented. Every pin can be used as a **digital input or output**, for blinking LEDs or reading button presses. These pins are referenced in the Arduino IDE via an integer value between 0 and 23. (The A0-A10 pins can be referenced digitally via either their analog pin number or digital pin number).

Eleven pins feature analog to digital converters (ADCs) and can be used as **analog inputs**. These are useful for reading potentiometers or other analog devices using the `analogRead([pin])` function.

There are six pins with pulse width modulation (PWM) functionality, which allows for a form of **analog output** using the `analogWrite([pin], [value])` function. These pins are indicated on-board with a faint white circle around the pin.

There are also hardware UART (serial), I²C, and SPI pins available. These can be used to interface with digital devices like serial LCDs, IMUs, and other serial sensors.

The Fio v3 has five external interrupts, which allow you to instantly trigger a function when a pin goes either high or low (or both). If you attach an interrupt to an interrupt-enabled pin, you'll need to know the specific interrupt that pin triggers: pin 3 maps to interrupt 0, pin 2 is interrupt 1, pin 0 is interrupt 2, pin 1 is interrupt 3, and pin 7 is interrupt 4.

On-Board LEDs

There are a variety of LEDs on the Fio, the simplest of which is the red **power** indicator. Two LEDs towards the bottom – labeled RX and TX – help indicate when data is transferring to and from the Fio through USB. A blue LED represents USB data coming *into* ('RX') the the Pro Micro, and a yellow LED indicates USB data going out ('TX').

There are three LEDs tied to the XBee interface in particular: stat, RSSI, and associate. The red LED labeled '**ON**' is connected to the XBee's pin 13 – DIO9 – which is, by default, set to indicate the XBee module's ON/OFF status. An '**RSSI**' LED connects to XBee pin 6 (PWM0) which defaults to indicate RSSI (received signal strength) – a brighter LED means a stronger received signal. Lastly, the '**ASO**' LED connects to XBee pin 15, which will blink if the module is associated.

Finally, there's a yellow LED labeled '**CHG**' which indicates if an attached lithium polymer battery is charging. If a battery is *not* connected to the Fio, the LED will be in an undefined state, and most likely be illuminated.

How to Power the Fio v3

The suggested power supply for the Fio v3 is any **single-cell lithium polymer (LiPo) battery**. These batteries have a nominal voltage of 3.7V, which is perfect for supplying power to the 3.3V-operating Fio. LiPos are awesome, because they're rechargeable and still pack a lot of power into a tiny space. Any of our single cell LiPos with JST terminators can connect directly to the Fio's onboard JST connector.

As an (immobile) alternative to batteries, the Fio can be powered directly through the **USB connector**.

Using the LiPo Charger

The Fio v3 has a **LiPo charge management** circuit (based around the MCP73831) built onto it, which handles the signal conditioning required to safely charge a single-cell LiPo battery.

To use the charge circuit, you'll obviously need a single-cell LiPo battery plugged into the Fio. Then connect the board up via USB, so the charge circuit has a primary voltage source to supply charge to the battery.

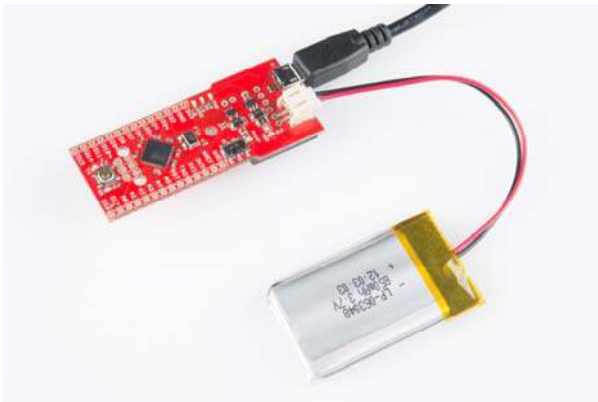

The 'CHG' LED will indicate the status of the battery charge. If it's on, the battery is still charging. Once the 'CHG' LED goes off, the battery is fully charged.

The charge circuit is programmed to charge the battery at 500mA, so, to be safe, the battery should be no smaller than 500mAH in capacity.

Connecting An XBee

The XBee-footprint connectors on the bottom of the Fio v3 are what make it so unique. This product is designed to provide a simple interface between Arduino and XBee, as such a few of the XBee pins come wired up to the

ATmega32U4. Most significantly, the serial interfaces of both devices are wired – the XBee’s ‘DOUT’ pin is connected to the ATmega32U4’s ‘RX’, and ‘DIN’ is connected to ‘TX’.

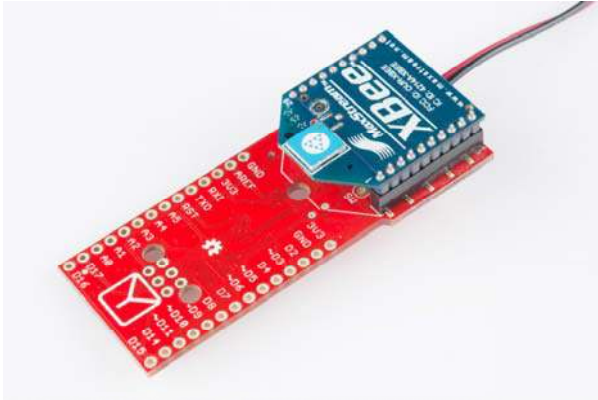

XBee’s are controlled and configured over a serial interface. To learn more about using XBee’s check out their datasheet and various tutorials for help getting started with these awesomely simple wireless transceivers.

Installing: Windows

Getting the Pro Micro or Fio v3 set up on your computer and in your Arduino environment can be difficult. Follow along on this page for a step-by-step guide through the driver installation and Arduino-enabling process.

Windows Driver Installation

A note to **Windows 8 users**: Before you can install these drivers, you’ll need to disable driver signature enforcement. Please check out our quick Disabling Driver Signature Enforcement tutorial for help with that.

Step 1: Download the Driver

Before plugging your board in, get a head start by **downloading the drivers** (check the GitHub Repository for the latest files). The same driver file works for both the Pro Micro and the Fio v3.

Unzip that zip file, and don’t forget where you’ve left its contents. In that zip file, you should find an INF file, which contains all the information Windows needs to install the Pro Micro’s driver.

Step 2: Plug in the Pro Micro / Fio v3

When you initially **plug the board in**, an “Installing device driver software” bubble notification should pop up in the lower-right corner of your taskbar. After the green dot circles the grey box a number of times, you’ll probably get a sad bubble like this:

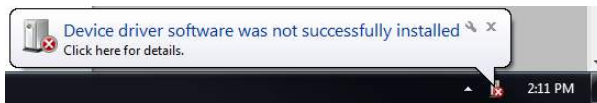

Never fear! Windows just doesn't know where to find our driver.

Note: Some users have experienced issues when plugging the Pro Micro into a USB 3.0 port. If you experience issues on USB 3.0 ports, try switching to use a USB 2.0 port.

Step 3: Open the Device Manager

From here, the most straightforward way to install the driver is through the Device Manager. To get to the Device Manager, click the **Start** button, then open the **Control Panel**. In the Control Panel, click **System and Maintenance**, and then open the **Device Manager**.

Alternatively, you can open the **Run prompt** (Windows key+R) and type 'devmgmt.msc' and click OK.

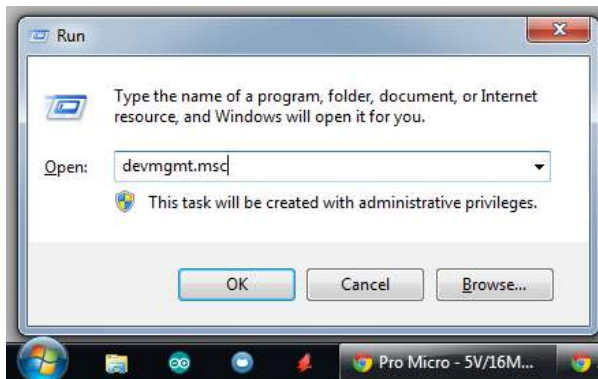

In the Device Manager, expand the 'Other devices' tree, where you should find a '**USB IO Board**' with a yellow warning sign over its icon. Right-click the 'USB IO Board' and select **Update Driver Software....**

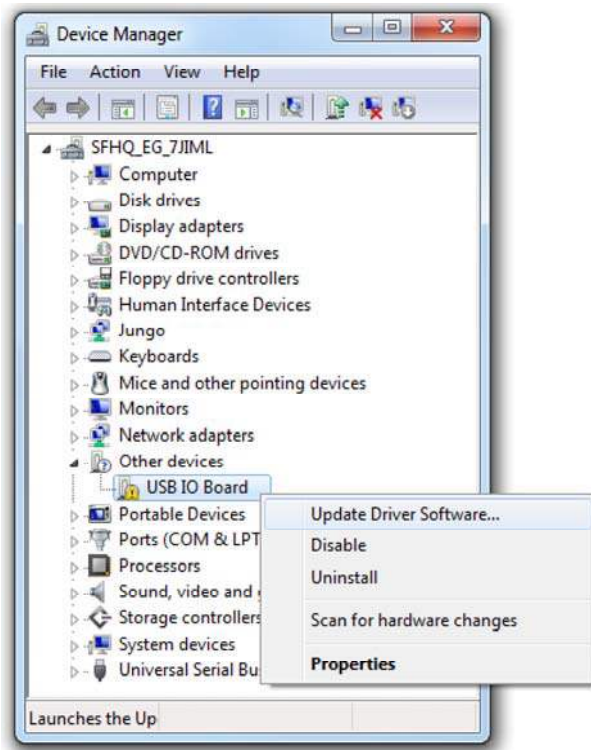

This should spawn an 'Update Driver Software - USB IO Board' window.

Step 4: Finding the Driver

In the first window that pops up, click '**Browse my computer for driver software**'. On the next window, click '**Browse...**' to search for the driver you just downloaded. It should be a folder named 'SFE32U4_Drivers'. After you've selected the 'driver' folder, click **OK**, then select **Next**.

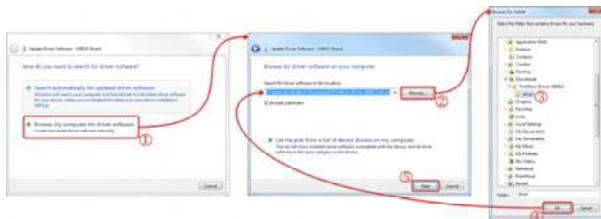

Windows will attempt to do its driver install thing, but not before complaining about the driver being unsigned. It's safe to select '**Install this driver software anyway**' on the warning dialog.

After watching the progress bar beam by a few times, you should get a happy 'Windows has successfully updated your driver software' window. And the 'Device Manager' should have a new entry for the 'SparkFun Pro Micro (COM ##)' (or 'SparkFun Fio V3 (COM##)' if you have one of those) under the 'Ports' tree.



Take note of which COM port your Pro Micro was assigned. We'll need it soon.

Installing the Arduino Addon

We're still not completely ready for Arduino, but this is the final stretch. Before you can use the ProMicro in the Arduino IDE, you need to enable it and activate some super-secret Arduino files.

To begin, **download this zip folder**, and unzip its contents into a **'hardware'** directory within your Arduino sketchbook.

Note: These Arduino addon files only work with **Arduino 1.5** and up. If you're using an earlier version of Arduino, either update (and get some cool new features), or download the older version of the Addon.

Where's your Arduino sketchbook? Well, by default, it should be an 'Arduino' folder in your **home directory**, but to double check you can go to 'File' > 'Preferences' within Arduino and check the 'Sketchbook location' text box. Just make sure you close all Arduino windows once you're done.

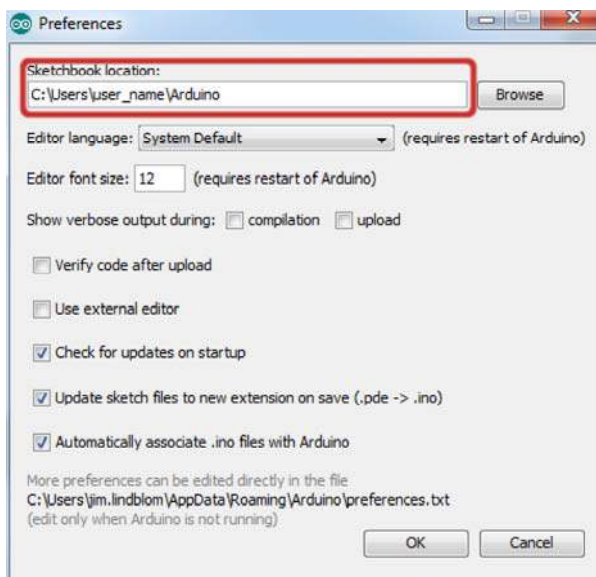

Once you've unzipped that folder into the 'hardware' folder within your Arduino sketchbook (you may actually have to create a hardware folder), your directory structure should look something like this:

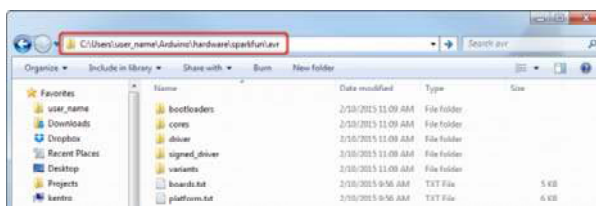

The structure of this directory is critical – it should look something like “Arduino/hardware/[manufacturer]/[architecture]”, in this case [manufacturer] is “sparkfun”, and [architecture] is “avr.”

There’s a lot going on in that add-on, but one of the most important files is ‘boards.txt’, which will add a few new entries to your ‘Tools > Board’ menu.

To double-check that the board definitions have been added to Arduino, **open up Arduino**, and check under the ‘Tools > Board’ menu. There should be some new entries for ‘SparkFun Pro Micro 8MHz/3.3V’, ‘SparkFun Pro Micro 16MHz/5V’, and other 32U4 boards.

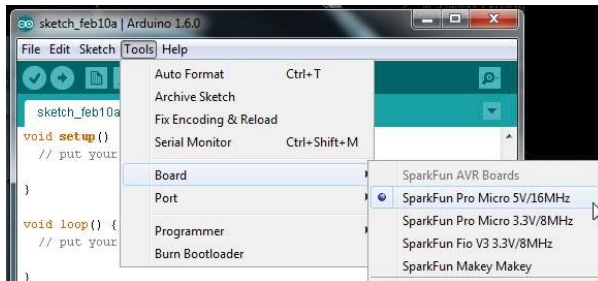

Notice there are two options for Pro Micro - 8MHz and 16MHz. It’s very important that you **select the Pro Micro option that matches your board’s voltage and speed**. Don’t know which board you have? Check the bottom of the board, where you should find either a ‘5V’ or ‘3.3V’ box checked.

You should also see your Pro Micro’s **COM port** under the ‘Tools > Serial Port’ menu. Select it, and head over to the Example 1 page where we’ll upload our first piece of code.

Installing: Mac & Linux

If you’re using Mac or Linux, follow the steps below to get your Pro Micro (or Fio v3) ready to go on your computer. We’re not going to name names here, but installing the Pro Micro on Mac OS X and Linux is *a lot* easier than on other OS’s...

Following these directions is critical to getting your Pro Micro supported within your Arduino environment!

Board Installation

When you initially plug your Pro Micro into a Mac, it’ll pop up a “Keyboard Setup Assistant” window. This stems from the Pro Micro’s ability to emulate an HID USB device (e.g. keyboards and mice) – the Mac thinks your Pro Micro is a human input device (which it could be! but isn’t yet).

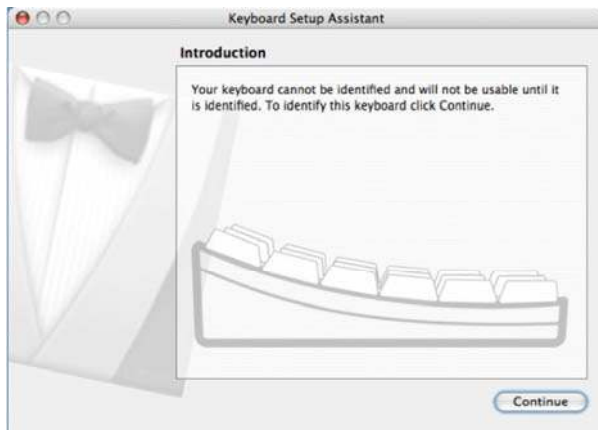

There's nothing to configure in this window, so just click the big, red, 'X' to close it.

That's all there is to it! The CDC (communication device class) portion of your Pro Micro (the part that handles USB to Serial conversion) should automatically install on your computer.

Installing the Arduino Addon

In order to use the Pro Micro or Fio v3 in your Arduino IDE, you need to add a few board definition files to it. That's what we'll do in this section. Begin by **downloading the Pro Micro addon files**.

Note: These Arduino addon files only work with **Arduino 1.5** and up. If you're using an earlier version of Arduino, either update (and get some cool new features), or download the older version of the Addon.

With that downloaded, follow these steps to enable the Pro Micro in your Arduino environment:

1. The addon files are supplied in a zip folder, so you'll need to **extract the files** within first.
2. Find your **Arduino sketchbook folder**. If you don't know where it is, you can locate your sketchbook by looking at the preferences dialog in your Arduino IDE.
3. If there isn't already one, create a folder in your sketchbook called **'hardware'**.
4. Copy the 'sparkfun' folder that was unzipped in the first step into the 'hardware' folder.
 - Your directory structure should look something like "Arduino/hardware/sparkfun/avr."
5. Restart Arduino, and look under the Tools > Board menu. You should see a few new options, including 'SparkFun Pro Micro 5V/16MHz', 'SparkFun Pro Micro 3.3V/8MHz', and "SparkFun Fio V3 3.3V/8MHz".

If the boards are visible, select the option that matches your board. If you have a Pro Micro, make sure you select the correct operating speed and voltage! Then head over to the next page where we'll upload our first sketch!

Example 1: Blinkies!

The Arduino-standard Blink sketch won't have any visible effect on the Pro Micro – there's no LED on pin 13. In fact, the only LEDs on the board are the power indicator, and RX/TX blinkies. Unlike other Arduino boards, though, we can control the RX/TX LEDs in our sketch. So let's get blinking!

Upload the RX/TX Blinky Sketch

Copy and paste the code below, and upload* it to your Pro Micro.

```
/* Pro Micro Test Code
   by: Nathan Seidle
   modified by: Jim Lindblom
   SparkFun Electronics
   date: September 16, 2013
   license: Public Domain - please use this code however yo
u'd like.
   It's provided as a learning tool.

   This code is provided to show how to control the SparkFun
   ProMicro's TX and RX LEDs within a sketch. It also serves
   to explain the difference between Serial.print() and
   Serial1.print().
*/

int RXLED = 17; // The RX LED has a defined Arduino pin
// The TX LED was not so lucky, we'll need to use pre-defined
// macros (TXLED1, TXLED0) to control that.
// (We could use the same macros for the RX LED too -- RXLED1,
// and RXLED0.)

void setup()
{
  pinMode(RXLED, OUTPUT); // Set RX LED as an output
  // TX LED is set as an output behind the scenes

  Serial.begin(9600); //This pipes to the serial monitor
  Serial1.begin(9600); //This is the UART, pipes to sensors att
ached to board
}

void loop()
{
  Serial.println("Hello world"); // Print "Hello World" to th
e Serial Monitor
  Serial1.println("Hello!"); // Print "Hello!" over hardware U
ART

  digitalWrite(RXLED, LOW); // set the LED on
  TXLED0; //TX LED is not tied to a normally controlled pin
  delay(1000); // wait for a second
  digitalWrite(RXLED, HIGH); // set the LED off
  TXLED1;
  delay(1000); // wait for a second
}
```

With the code uploaded you should see the RX and TX LEDs take turns blinking on and off every second. You can also open up the serial monitor (set to 9600 bps) and see every programmer's favorite two-word phrase.

Understanding the Sketch

The RX LED is tied to Arduino's pin 17. You can control it just as you would any other digital pin. Set it as an `OUTPUT`, and `digitalWrite([pin], [level])` it `HIGH` or `LOW`. The TX LED was not provided as an Arduino-defined pin, unfortunately, so you'll have to use a pair of macros to control it. `TXLED1` turns the LED on, and `TXLED0` turns the LED off.

In that sketch, you'll also notice a pair of **Serial** initialization statements: `Serial.begin(9600)`, `Serial1.begin(9600)`. That '1' makes a huge difference. Think of the Pro Micro having two separate serial ports. The one *without* the '1' is for communication to and from the computer over USB; this is what is visible in the Serial Monitor. The `Serial1` port is a bonafide, **hardware UART**, where your Pro Micro can talk to any serial-enabled piece of hardware.

If you open up the **Serial Monitor**, you should only see 'Hello world' printed. 'Hello!' is being sent out over the hardware UART, where, presumably, nothing is listening. This begs the age-old question: "if a Pro Micro is saying 'Hello!' over the hardware serial port, and nothing is there to hear it, does the Pro Micro really say anything at all?"

Why Does My Board Re-Enumerate Every Upload?

In order to communicate serially, the Pro Micro emulates a **virtual serial port**. Actually, it emulates two different serial ports – one for the bootloader, and one for the sketch. Since the bootloader and sketch run individually. Only one of these serial ports is visible at any one time.

When you click 'Upload' in the Arduino IDE, the Pro Micro resets itself and starts its **bootloader** program. (The bootloader is a low-level program on the Pro Micro which enables self-programming via serial.) To our operating system, the bootloader looks like a completely different device, so it gets its own serial port number. While the Pro Micro is being programmed, the bootloader serial port will be open. When the sketch upload is finished, the bootloader will exit, that serial port will be closed, and the regular Pro Micro serial port will open up.

What this all boils down to is the fact that you have to **be patient** with Pro Micros. Every time you upload a new sketch, your OS will need to work its driver magic before you can open up the COM port. This can take a few seconds after the code has finished uploading.

* **Note for Windows users:** The first time you upload a sketch, it may fail and give you an error. On top of that Windows will pop up that familiar 'Device driver software was not successfully installed' notification. Don't let this worry you too much. If you get the error, wait about a minute, and try uploading again.

Hopefully the upload will succeed the second time, but if it continues to fail, check out the how to enter the bootloader section of the FAQ. Windows needs to install the same driver we've already installed for the Pro Micro's bootloader, but it's unable to get everything set up before the bootloader exits.

Example 2: HID Mouse and Keyboard

By far, the Pro Micro's most revolutionary feature (as far as Arduinos go) is its true USB functionality. The Pro Micro can be programmed to emulate any USB device you could imagine. You can even program it to act just like a mouse, keyboard, or other HID-class USB device.

What is **HID**? It's one of the many defined USB device classes. Every USB device is assigned a class, which defines what its general purpose is. There are loads of classes – printers, hubs, speakers, and webcams to mention a few, but in this example we'll be emulating HID – **Human Interface Device**. The ATmega32U4 takes care of the USB-hardware hurdle, but we've still got to clear the firmware one. Time for some example code!

USB Keyboards Made Simple

To emulate a USB keyboard, we'll be making use of the `Keyboard` class. Here are some of the functions made available to us by this class:

- **`Keyboard.write(char)`** - This function will send a single character over USB. The character passed can be any standard, printable, ASCII-defined character: 0-9, a-z, A-Z, space, symbols, etc. Here's an example line of code:

```
Keyboard.write('z') // This will send a single 'z' character to your computer.
```

- **`Keyboard.print(string)`** - If you need to perform a series a `Keyboard.write()`'s, consider using just a single `Keyboard.print()`. This works similar to `Serial.print()` – give it a string of characters and it'll send that stream of characters over USB. **`Keyboard.println(string)`** is also defined, if you want a newline/linefeed to close out your string. An example:

```
Keyboard.print("Hello, world"); // This'll send your computer an 'H', followed by 'e', followed by...
```

- `Keyboard.press(byte)` and `Keyboard.release(byte)` give you more precise control over key presses. They do exactly what you'd expect. One presses a button down, the other releases a button. Make sure you release any buttons you press, otherwise you'll encounter some wiggyness on your computer.

That's it. You don't need to include any libraries or anything, just invoke any of those functions. Here's an **example sketch** to try it out:

```
int buttonPin = 9; // Set a button to any pin

void setup()
{
  pinMode(buttonPin, INPUT); // Set the button as an input
  digitalWrite(buttonPin, HIGH); // Pull the button high
}

void loop()
{
  if (digitalRead(buttonPin) == 0) // if the button goes low
  {
    Keyboard.write('z'); // send a 'z' to the computer via Keyboard HID
    delay(1000); // delay so there aren't a kajillion z's
  }
}
```

In this sketch, **connecting pin 9 to ground** will make the Pro Micro spit out a 'z' character. If you have a simple, **momentary button** handy, tie one end to pin 9 and the other to ground. Otherwise, just use a wire to short 9 to GND.

After a `Keyboard.write()` or `Keyboard.print()` function has been performed by the Pro Micro, your computer will have to decide what to do with it. What your computer does with that character, or string of characters, is entirely dependent on what program it's running at the time. If you have a text editor open and active, it'll print it out there.

USB Mouse Functionality

That covers about half of USB HID library. How about we add a mouse to the mix now? Implementing a USB HID mouse requires a few more functions, but it's still crazy simple. There are five functions provided by Arduino's HID class that can be used to implement a mouse:

- `Mouse.move(x, y, wheel)` tells the computer to move the mouse a certain number of pixels along either the x, y and/or wheel axis. Each variable can be any value between -128 and +127, with negative numbers moving the cursor down/left, positive numbers move the right/up.
- `Mouse.press(b)` sends a down-click on a button or buttons. The button(s) will remain “pressed” until you call `Mouse.release(b)`. The `b` variable is a single byte, each bit of which represents a different button. You can set it equal to any of the following, or OR (|) them together to click multiple buttons at once:
 - `MOUSE_LEFT` - Left Mouse button
 - `MOUSE_RIGHT` - Right Mouse button
 - `MOUSE_MIDDLE` - Middle mouse button
 - `MOUSE_ALL` - All three mouse buttons
- `Mouse.click(b)` sends a down-click (press) followed immediately by an up-click (release) on button(s) `b`. For example, to click the left and right buttons simultaneously, try this:

```
Mouse.click(MOUSE_LEFT | MOUSE_RIGHT); // Press and release the left and right mouse buttons
```

Here's some **example code** to show off these functions:

```

/* HID Joystick Mouse Example
   by: Jim Lindblom
   date: 1/12/2012
   license: MIT License - Feel free to use this code for any purpose.
   No restrictions. Just keep this license if you go on to use this
   code in your future endeavors! Reuse and share.

   This is very simplistic code that allows you to turn the
   SparkFun Thumb Joystick (http://www.sparkfun.com/products/9032)
   into an HID Mouse. The select button on the joystick is set up
   as the mouse left click.
*/
int horzPin = A0; // Analog output of horizontal joystick pin
int vertPin = A1; // Analog output of vertical joystick pin
int selPin = 9; // select button pin of joystick

int vertZero, horzZero; // Stores the initial value of each axis, usually around 512
int vertValue, horzValue; // Stores current analog output of each axis
const int sensitivity = 200; // Higher sensitivity value = slower mouse, should be <= about 500
int mouseClickFlag = 0;

void setup()
{
  pinMode(horzPin, INPUT); // Set both analog pins as inputs
  pinMode(vertPin, INPUT);
  pinMode(selPin, INPUT); // set button select pin as input
  digitalWrite(selPin, HIGH); // Pull button select pin high
  delay(1000); // short delay to let outputs settle
  vertZero = analogRead(vertPin); // get the initial values
  horzZero = analogRead(horzPin); // Joystick should be in neutral position when reading these
}

void loop()
{
  vertValue = analogRead(vertPin) - vertZero; // read vertical offset
  horzValue = analogRead(horzPin) - horzZero; // read horizontal offset
}

```

```

if (vertValue != 0)
  Mouse.move(0, vertValue/sensitivity, 0); // move mouse o
n y axis
if (horzValue != 0)
  Mouse.move(horzValue/sensitivity, 0, 0); // move mouse o
n x axis

if ((digitalRead(selPin) == 0) && (!mouseClickFlag)) // if
the joystick button is pressed
{
  mouseClickFlag = 1;
  Mouse.press(MOUSE_LEFT); // click the left button down
}
else if ((digitalRead(selPin))&&(mouseClickFlag)) // if the
joystick button is not pressed
{
  mouseClickFlag = 0;
  Mouse.release(MOUSE_LEFT); // release the left button
}
}

```

This sketch is set up so that an analog joystick connected to analog pins A0 and A1 can be used to move your mouse cursor.

The `loop()` of this code continuously monitors the horizontal and vertical analog values of the joystick and sends the `Mouse.move()` command based on what it reads. It'll move the mouse in steps, depending on what the sensitivity variable is set to. With sensitivity set to 2, the cursor will move in either 1 or 2 pixel steps.

The select switch on the joystick is used to control the mouse left click. Notice this code is using `Mouse.press()` and `Mouse.release()`, rather than just calling a single `Mouse.click()`. This requires a bit more coding, but it allows you to do things like drag-and-drop, double click, etc.

For more HID example code, check out the Arduino-supplied examples under the 'File' > 'Examples' > '09.USB' menu.

Troubleshooting and FAQ

On this page you'll find troubleshooting tips and FAQs. Here's a directory of the subjects covered:

- **Troubleshooting**
 - Serial Port Not Showing Up in "Tools > Board" menu
 - How to Reset to Bootloader
 - How to Revive a "Bricked" Pro Micro

• Frequently Asked Questions

- What are VIDs and PIDs?
- How Can I Change the VID and PID on an ATmega32U4?
- Why Does my ATmega32U4 Board Show up Twice in the Device Manager?
- How Does the IDE Know Which COM Port to Use?
- How Do I Reinstall the Bootloader?

Serial Port Not Showing Up in ‘Tools > Board’ Menu

The Pro Micro can be a finicky little thing. There are a few series of events that can lead to its serial port being removed from the Arduino IDE’s Serial Port selection menu. If you can’t see your Pro Micro’s serial port, give these steps a try:

1. Close *all* Arduino windows. (Don’t forget to save!)
2. Unplug Pro Micro from your computer.
3. Wait a few seconds for the device to be detached.
4. Plug Pro Micro back in.
5. Open Arduino back up, check the Serial Ports menu again.

Reset to Bootloader

We ship the Pro Micro with a modified version of the Arduino Leonardo bootloader, with one major enhancement. When a Leonardo (or any device using the “stock” bootloader) is externally reset, it goes back into the bootloader...and waits there eight seconds before it starts running the sketch. For some embedded projects, waiting eight seconds before a program runs isn’t acceptable, so we modified the bootloader run time.



Leonardo bootloader on reset functionality.

When a Pro Micro is externally reset (by pulling the RST pin low), it’ll only briefly (<750ms) start the bootloader before continuing on to the sketch. If you need the bootloader to run longer, **resetting twice quickly** will get the Pro Micro to enter bootloader mode for eight seconds.



Pro Micro and Fio v3 reset functionality. Press reset twice, quickly to enter bootloader mode.

Resetting the Pro Micro's, in particular, can be tricky, because there's no reset button. The 'RST' pins needs to be connected to ground to initiate a reset. This can be done with a small piece of wire, or an externally connected button.

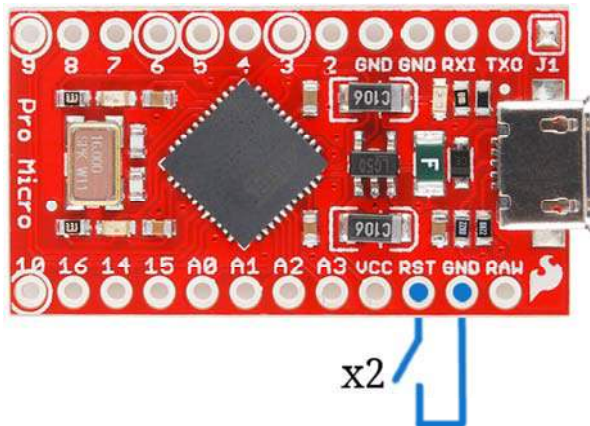

Why would you need to enter bootloader mode in the first place. Glad you asked...

How to Revive a “Bricked” Pro Micro

Incorporating all of the USB tasks on a single chip is an awesome feature that makes the Pro Micro and boards like it truly unique. But it also places more stress on a single chip, and if anything goes wrong with that chip, the board becomes nearly unusable. It's not uncommon for Pro Micro's to become “bricked” and unprogrammable. But, in most cases, the bricking is reversible!

The most common source of Pro Micro “bricking” is uploading code to it with an **incorrectly set board** (e.g. programming a 16MHz/5V Pro Micro with the board set to 8MHz/3.3V). Also, make sure your sketch doesn't mess with the ATmega32U4's PLLCSR register, or any other register that sets up USB functionality on the ATmega32U4. The Pro Micro will actually take code compiled for the wrong operating speed, but when it tries to re-enumerate, you'll be greeted with a notification like this:



To revive the Pro Micro, you'll need to find a way to upload a sketch to it with the board option correctly set. We can do this with a little help from the bootloader.

First, you'll need to **set the serial port to the bootloader**. But that port is only visible when the board is in bootloader mode, so pull the reset line low twice quickly to invoke the bootloader reset feature discussed above. On Pro Micro's, or other devices which don't have a reset button, you can either use a wire to quickly short 'RST' to 'GND' twice, or wire up a temporary reset button. **While the Pro Micro is in the bootloader** change the 'Tools > Serial Port' menu to the bootloader COM port. Quick! You've only got eight seconds. On Windows, the bootloader's COM port number is usually one number higher than the Pro Micro's regular port number.

With the serial port set, we're just about ready to re-upload our sketch. But first, **double check that the board is correctly set**. Then **reset to bootloader again**, and quickly upload your sketch. Again, you'll have to be quick...you've only got eight seconds. It may help to press the Upload keybind – CTRL+U / CMD+U – immediately after resetting.

It can take a few tries to get the timing right. Since the code has to compile first, it may help to **hit upload first** and then reset.

Frequently Asked Questions

If you're having technical difficulties with your Pro Micro or Fio v3, see if any of the answers to these FAQs help. If not, please get in touch with our tech support team.

What are VID and PIDs?

VID is short for 'Vender Identification' and PID is short for 'Part Identification'. In other words, this pair of IDs defines the device. This is how your computer knows what you've plugged in, what drivers to use with it, what COM port is assigned to it, etc. All native USB devices have a VID/PID.

All SparkFun ATmega32U4 boards share the same VID – 0x1B4F, and they all have unique PIDs. 5V Pro Micros lay claim to PIDs 0x9205 and 0x9206 (one for the bootloader, one for the sketch). 3.3V Pro Micros will show up as 0x9203 and 0x9204 for bootloader and sketch, respectively. And the Fio v3 has 0xF100 and 0xF101.

How Can I Change the VID and PID on an ATmega32U4 Board?

Every time you upload code the VID and PID are uploaded to the device. These values are located in the 'boards.txt' file and will therefore be determined by the board you have selected. Keep in mind that if you select the wrong board you will get the wrong VID/PID uploaded which means the

computer can't recognize, and program the board. The VID/PID for the bootloader is part of the bootloader file. To change this you will need to recompile the bootloader with the new VID/PID, and upload it.

Why Does my ATmega32U4 Board Show up Twice in Device Manager?

Both the bootloader and the sketch have their own VID/PIDs. When you plug in a board the bootloader starts running for a few seconds, and you will see the board show up in Device Manager based on those VID/PIDs. After a few seconds, the sketch will start running, and you will see Device Manager disconnect from the bootloader and connect to the sketch.

How Does the IDE Know Which COM Port to Use?

When the IDE resets the board, the COM port is disconnected from the computer. The IDE then looks for a new COM port. This is the port it uses. This is one of those weird things Arduino did to get things to work on this chip.

How Do I Reinstall the Bootloader?

Check out or reinstalling the bootloader tutorial, which should work for both ATmega32U4 and ATmega328 boards. If you have the tools to do so, reinstalling the bootloader is often easier than trying to stay in the bootloader. Since reinstalling the bootloader puts the board back in factory settings this will reset the VID/PID numbers allowing your board to work again.

Resources & Going Further

Thanks for checking out our Pro Micro and Fio v3 Hookup Guide! If you're looking for more resources related to these boards, here are some links:

- [Pro Micro Schematic](#)
- [Pro Micro EAGLE Files](#)
- [Fio v3 Schematic](#)
- [Fio v3 EAGLE Files](#)
- [ATmega32U4 Datasheet](#)
- [ATmega32U4 Arduino Addon GitHub Repository](#)

Going Further

Thanks for reading along with our Pro Micro hookup guide! Hopefully now you're fully prepared to begin using the Pro Micro in a project of your own. Here are some tutorials that might be worth checking out as you continue down the rabbit hole:

- [Exploring XBees and XCTU](#)
- [Arduino Programming 101](#)

- [Arduino Comparison Guide](#)
- [Connecting Arduino to Processing](#)
- [Using the Arduino Pro Mini 3.3V](#)