



















- 1 
- 2 
- 3 
- 4 
- 5 
- 6 
- 7 
- 8 
- 9 
- 10 
- 11 
- 12 
- 13 
- 14 
- 15 
- 16 
- 17 
- 18 

**HANDLE SHANKS**

Die-cast aluminium, epoxy resin coating, black colour, semi-matte finish.

Holes for black zinc-plated cylindrical-head screws with hexagon socket, glossy zinc-plated nuts and washers, included in the supply.

**TUBE**

Natural colour anodised aluminium profile, satin finish.

**FEATURES AND APPLICATIONS**

MS series handles are extremely resistant with an excellent ergonomics and design.

They are generally used on machines and equipment.

**SPECIAL EXECUTIONS ON REQUEST**

- RAL 7043 grey tube.
- Different lengths.

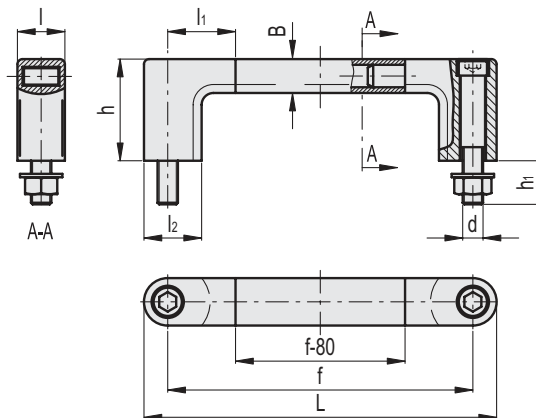

Conversion Table	
1 mm = 0.039 inch	
L	
mm	inch
228	8.89
278	10.84
328	12.79
428	16.69
528	20.59

Code	f	L	d	h1	B	h	l	l1	l2	⚖️
RHMS-01.200.62	200	228	M12	22	20	60	28	40	34	566
RHMS-01.250.62	250	278	M12	22	20	60	28	40	34	608
RHMS-01.300.62	300	328	M12	22	20	60	28	40	34	651
RHMS-01.400.62	400	428	M12	22	20	60	28	40	34	734
RHMS-01.500.62	500	528	M12	22	20	60	28	40	34	816