

TPS54618EVM-606 6-A, SWIFT™ Regulator Evaluation Module

This user's guide contains background information for the TPS54618 as well as support documentation for the TPS54618EVM-606 evaluation module (HPA606). Also included are the performance specifications, the schematic, and the bill of materials for the TPS54618EVM-606.

Contents

1	Introduction	2
2	Test Setup and Results	4
3	Board Layout	10
4	Schematic and Bill of Materials	13

List of Figures

1	TPS54618EVM-606 Efficiency	5
2	TPS54618EVM-606 Low Current Efficiency.....	5
3	TPS54618EVM-606 Load Regulation	6
4	TPS54618EVM-606 Line Regulation	6
5	TPS54618EVM-606 Transient Response	7
6	TPS54618EVM-606 Loop Response	7
7	TPS54618EVM-606 Output Ripple	8
8	TPS54618EVM-606 Input Ripple	8
9	TPS54618EVM-606 Start-Up Relative to V_{IN}	9
10	TPS54618EVM-606 Start-Up Relative to Enable	9
11	TPS54618EVM-606 Top-Side Layout	10
12	TPS54618EVM-606 Bottom-Side Layout	11
13	TPS54618EVM-606 Internal Layer 1	11
14	TPS54618EVM-606 Internal Layer 2	12
15	TPS54618EVM-606 Top-Side Assembly.....	12
16	TPS54618EVM-606 Schematic.....	13

List of Tables

1	Input Voltage and Output Current Summary	2
2	TPS54618EVM-606 Performance Specification Summary	2
3	Output Voltages Available	3
4	EVM Connectors and Test Points	4
5	TPS54618EVM-606 Bill of Materials.....	14

1 Introduction

1.1 Background

The TPS54618 dc/dc converter is designed to provide up to a 6-A output from an input voltage source of 2.95 V to 6 V. Rated input voltage and output current range for the evaluation module are given in [Table 1](#). This evaluation module is designed to demonstrate the small printed-circuit-board (PCB) areas that may be achieved when designing with the TPS54618 regulator. The switching frequency is externally set at a nominal 1000 kHz. The high-side and low-side MOSFETs are incorporated inside the TPS54618 package along with the gate-drive circuitry. The low drain-to-source on-resistance of the MOSFETs allows the TPS54618 to achieve high efficiencies and helps keep the junction temperature low at high output currents. The compensation components are external to the integrated circuit (IC), and an external divider allows for an adjustable output voltage. Additionally, the TPS54618 provides adjustable slow start and undervoltage lockout inputs. The absolute maximum input voltage is 7 V for the TPS54618EVM-606.

Table 1. Input Voltage and Output Current Summary

EVM	INPUT VOLTAGE RANGE	OUTPUT CURRENT RANGE
TPS54618EVM-606	$V_{IN} = 3\text{ V to }6\text{ V}$	0 A to 6 A

1.2 Performance Specification Summary

A summary of the TPS54618EVM-606 performance specifications is provided in [Table 2](#). Specifications are given for an input voltage of $V_{IN} = 5\text{ V}$ and an output voltage of 1.8 V, unless otherwise specified. The TPS54618EVM-606 is designed and tested for $V_{IN} = 3\text{ V to }6\text{ V}$. The ambient temperature is 25°C for all measurements, unless otherwise noted.

Table 2. TPS54618EVM-606 Performance Specification Summary

SPECIFICATION	TEST CONDITIONS	MIN	TYP	MAX	UNIT
V_{IN} operating voltage range		3	5	6	V
V_{IN} start voltage			2.8		V
V_{IN} stop voltage			2.6		V
Output voltage set point			1.8		V
Output current range	$V_{IN} = 3\text{ V to }6\text{ V}$	0		6	A
Line regulation	$I_O = 3\text{ A}, V_{IN} = 3\text{ V to }6\text{ V}$		±0.25%		
Load regulation	$V_{IN} = 3.3\text{ V}, I_O = 0\text{ A to }6\text{ A}$		±0.3%		
Load transient response	$I_O = 1.5\text{ A to }4.5\text{ A}$	Voltage change		-40	mV
		Recovery time		120	µs
	$I_O = 4.5\text{ A to }1.5\text{ A}$	Voltage change		40	mV
		Recovery time		120	µs
Loop bandwidth	$V_{IN} = 5\text{ V}, I_O = 5.2\text{ A}$		60		kHz
Phase margin	$V_{IN} = 5\text{ V}, I_O = 5.2\text{ A}$		58		°
Input ripple voltage	$I_O = 6\text{ A}$		100		mV _{PP}
Output ripple voltage	$I_O = 6\text{ A}$		8		mV _{PP}
Output rise time			3.5		ms
Operating frequency			1000		kHz
Maximum efficiency	$V_{IN} = 3.3\text{ V}, I_O = 1\text{ A}$		94.7%		

1.3 Modifications

These evaluation modules are designed to provide access to the features of the TPS54618. Some modifications can be made to this module.

1.3.1 Output Voltage Set Point

The voltage divider R9 and R10 is used to set the output voltage. To change the output voltage of the EVM, it is necessary to change the value of resistor R10. Changing the value of R10 can change the output voltage above 0.799 V. The value of R10 for a specific output voltage can be calculated using Equation 1.

$$R10 = 100 \text{ k}\Omega \times \frac{0.799 \text{ V}}{V_{\text{OUT}} - 0.799 \text{ V}} \quad (1)$$

Table 3 lists the R10 values for some common output voltages. Note that V_{IN} must be in a range so that the minimum on-time is greater than 75 ns, and the maximum duty cycle is less than 92%. The values given in Table 3 are standard values, not the exact value calculated using Equation 1.

Table 3. Output Voltages Available

Output Voltage (V)	R10 Value (kΩ)
1.0	402
1.2	200
1.5	115
1.8	80.6
2.5	47.5

1.3.2 Slow-Start Time

The slow-start time can be adjusted by changing the value of C7. Use Equation 2 to calculate the required value of C7 for a desired slow-start time.

$$C7(\text{nF}) = \frac{T_{\text{SS}}(\text{mS}) \times I_{\text{SS}}(\mu\text{A})}{V_{\text{REF}}(\text{V})} \quad (2)$$

Where $I_{\text{SS}} = 2 \mu\text{A}$.

C7 is set to 0.01 μF on the EVM for a default slow-start time of 4 ms.

1.3.3 Adjustable Undervoltage Lockout

The undervoltage lockout (UVLO) can be adjusted externally using R1 and R2. The EVM is set for a start voltage of 2.8 V and a stop voltage of 2.6 V using $R1 = 25.6 \text{ k}\Omega$ and $R2 = 20 \text{ k}\Omega$. Use Equation 3 and Equation 4 along with notes included in the TPS54618 datasheet to calculate required resistor values for different start and stop voltages.

$$R1 = \frac{0.944 \cdot V_{\text{START}} - V_{\text{STOP}}}{1.71 \times 10^{-6}} \quad (3)$$

$$R2 = \frac{1.18 \cdot R1}{V_{\text{STOP}} - 1.18 + R1 \cdot 3.5 \times 10^{-6}} \quad (4)$$

2 Test Setup and Results

This section describes how to properly connect, set up, and use the TPS54618EVM-606 evaluation module. The section also includes test results typical for the evaluation module and covers efficiency, output voltage regulation, load transients, loop response, output ripple, input ripple, and start-up.

2.1 Input/Output Connections

The TPS54618EVM-606 is provided with input/output connectors and test points as shown in [Table 4](#). A power supply capable of supplying 3 A must be connected to J1 through a pair of 20 AWG wires. The load must be connected to J3 through a pair of 20 AWG wires. The maximum load-current capability must be at least 6 A to use the full capability of this EVM. Wire lengths must be minimized to reduce losses in the wires. Test-point TP1 provides a place to monitor the V_{IN} input voltages with TP2 providing a convenient ground reference. TP8 is used to monitor the output voltage with TP9 as the ground reference.

Table 4. EVM Connectors and Test Points

Reference Designator	Function
J1	V_{IN} (see Table 1 for V_{IN} range).
J2	2-pin header for external tracking voltage.
J3	V_{OUT} , 1.8 V at 6 A maximum.
JP1	2-pin header for enable. Connect EN to ground to disable, open to enable.
JP2	2-pin header for to allow pull up of PWRGD to V_{IN}
TP1	V_{IN} test point at V_{IN} connector.
TP2	GND test point at V_{IN} .
TP3	Slow-start monitor test point.
TP4	PH test point.
TP5	PWRGD test point.
TP6	GND test point.
TP7	Test point between voltage divider network and output. Used for loop response measurements.
TP8	Output voltage test point at V_{OUT} connector.
TP9	GND test point at V_{OUT} connector.

2.2 Efficiency

The efficiency of this EVM peaks at a load current of about 0.5 A – 2 A and then decreases as the load current increases towards full load. Figure 1 shows the efficiency for the TPS54618EVM-606 at an ambient temperature of 25°C.

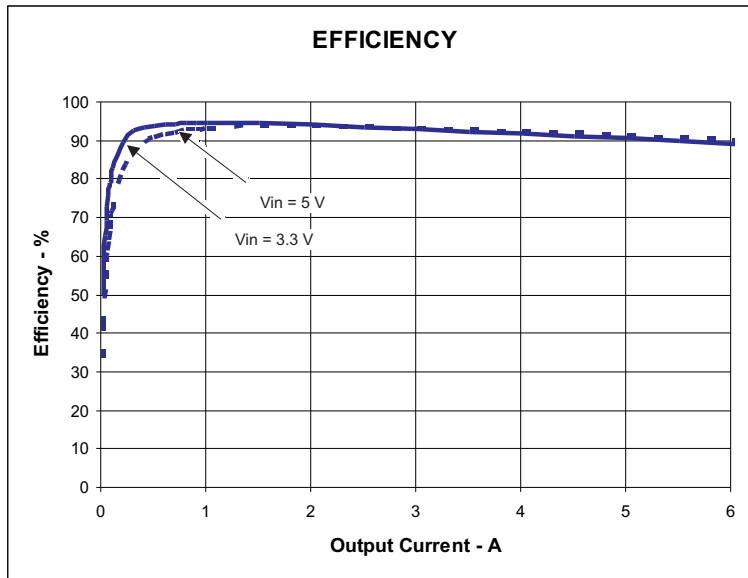

Figure 1. TPS54618EVM-606 Efficiency

Figure 2 shows the efficiency for the TPS54618EVM-606 at lower output currents at an ambient temperature of 25°C.

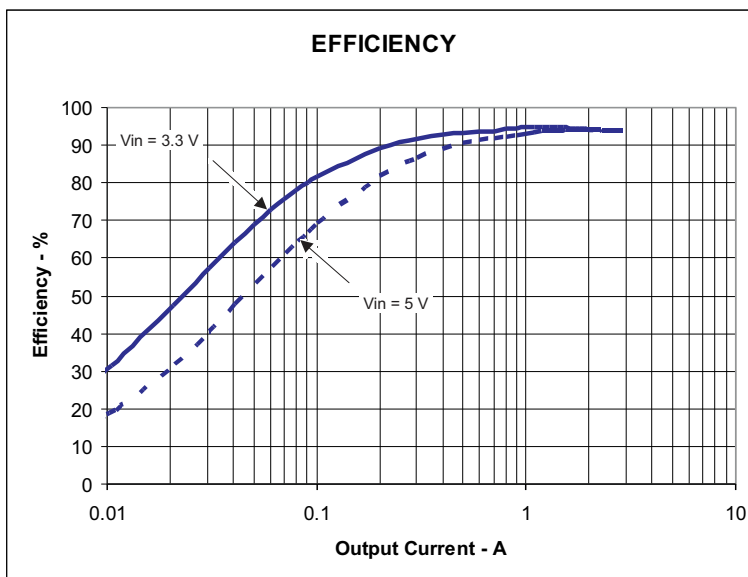

Figure 2. TPS54618EVM-606 Low Current Efficiency

The efficiency may be lower at higher ambient temperatures, due to temperature variation in the drain-to-source resistance of the internal MOSFET.

2.3 Output Voltage Load Regulation

Figure 3 shows the load regulation for the TPS54618EVM-606.

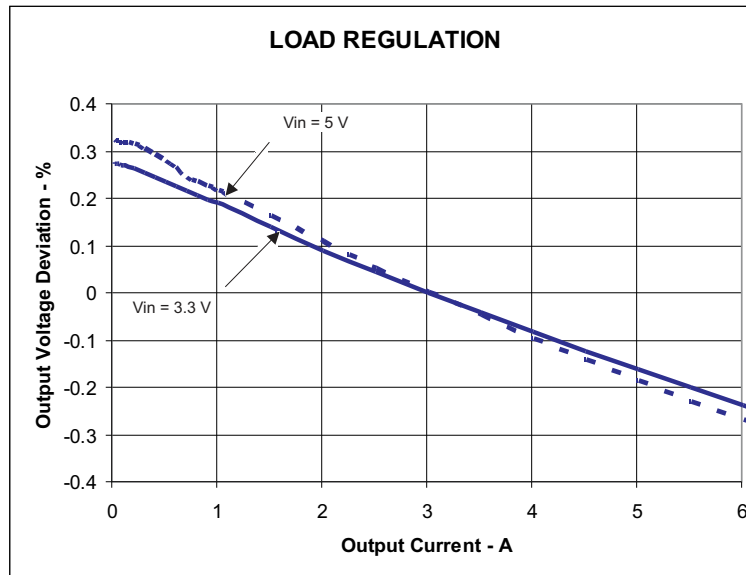

Figure 3. TPS54618EVM-606 Load Regulation

Measurements are given for an ambient temperature of 25°C.

2.4 Output Voltage Line Regulation

Figure 4 shows the line regulation for the TPS54618EVM-606.

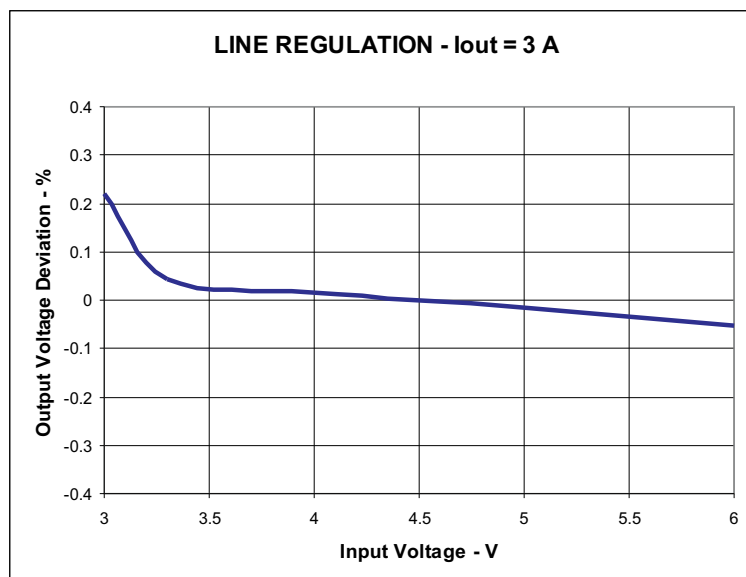

Figure 4. TPS54618EVM-606 Line Regulation

2.5 Load Transients

Figure 5 shows the TPS54318EVM-606 response to load transients. The current step is from 25% to 75% of maximum rated load at 3.3-V input. Total peak-to-peak voltage variation is as shown, including ripple and noise on the output.

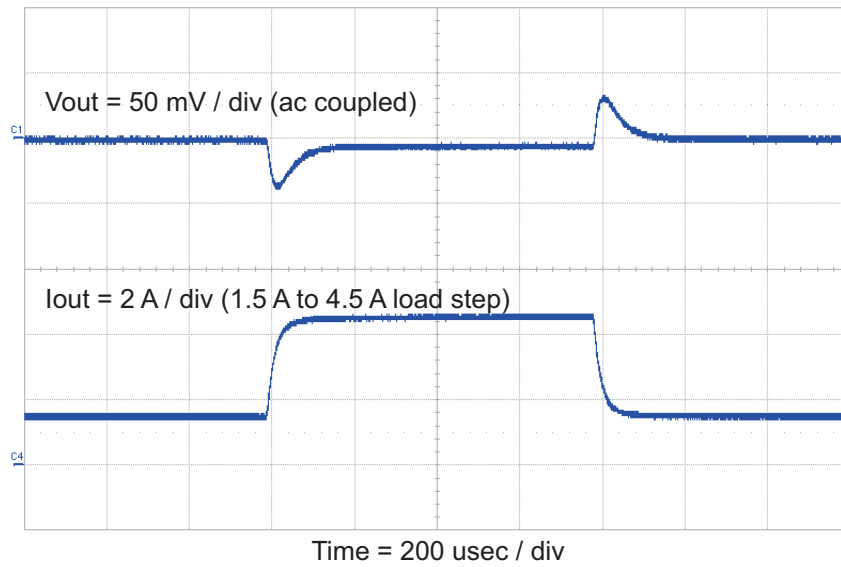

Figure 5. TPS54618EVM-606 Transient Response

2.6 Loop Characteristics

Figure 6 shows the TPS54618EVM-606 loop-response characteristics. Gain and phase plots are shown for V_{IN} voltage of 5 V. Load current for the measurement is 5.2 A.

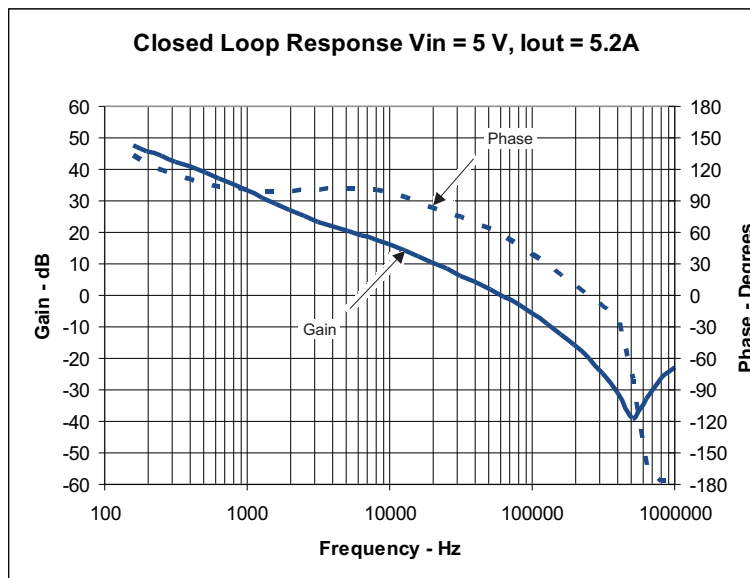

Figure 6. TPS54618EVM-606 Loop Response

2.7 Output Voltage Ripple

Figure 7 shows the TPS54618EVM-606 output voltage ripple. The output current is the rated full load of 6 A and $V_{IN} = 5$ V. The ripple voltage is measured directly across the output capacitors.

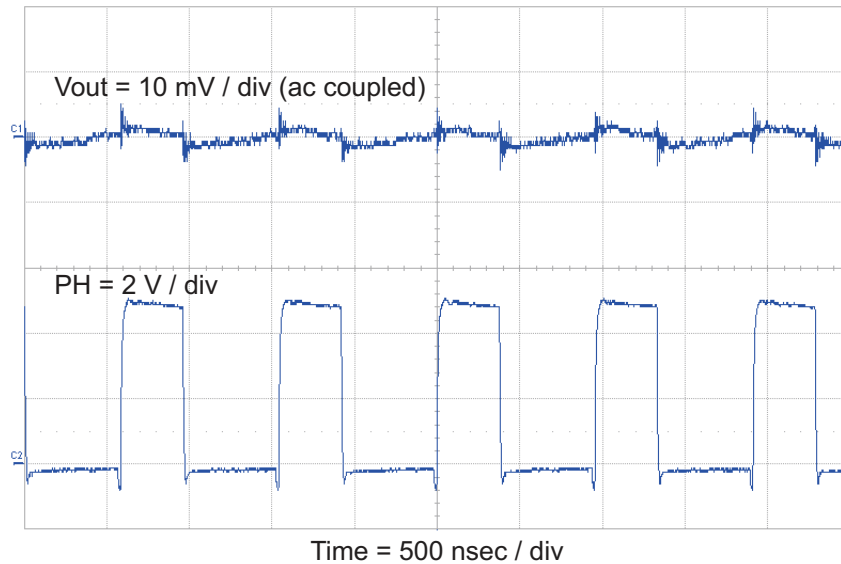

Figure 7. TPS54618EVM-606 Output Ripple

2.8 Input Voltage Ripple

Figure 8 shows the TPS54618EVM-606 input voltage ripple. The output current is the rated full load of 6 A and $V_{IN} = 5$ V. The ripple voltage is measured directly across the input capacitors.

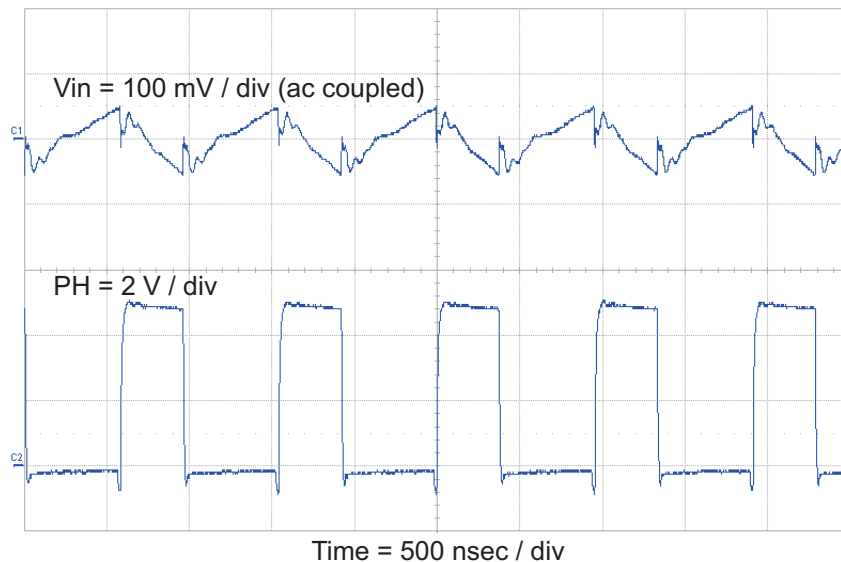

Figure 8. TPS54618EVM-606 Input Ripple

2.9 Powering Up

Figure 9 and Figure 10 show the start-up waveforms for the TPS54618EVM-606. In Figure 9, the output voltage ramps up as soon as the input voltage reaches the UVLO threshold as set by the R_1 and R_2 resistor divider network. In Figure 10, the input voltage is initially applied and the output is inhibited by using a jumper at JP1 to tie EN to GND. When the jumper is removed, EN is released. When the EN voltage reaches the enable-threshold voltage, the start-up sequence begins, and the output voltage ramps up to the externally set value of 1.8 V. The input voltage for these plots is 5 V and the load is 1 Ω .

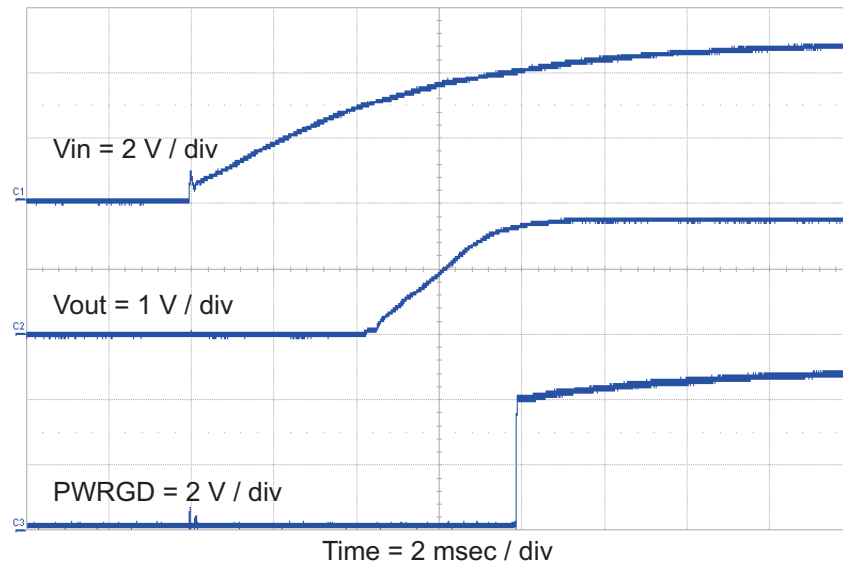

Figure 9. TPS54618EVM-606 Start-Up Relative to V_{IN}

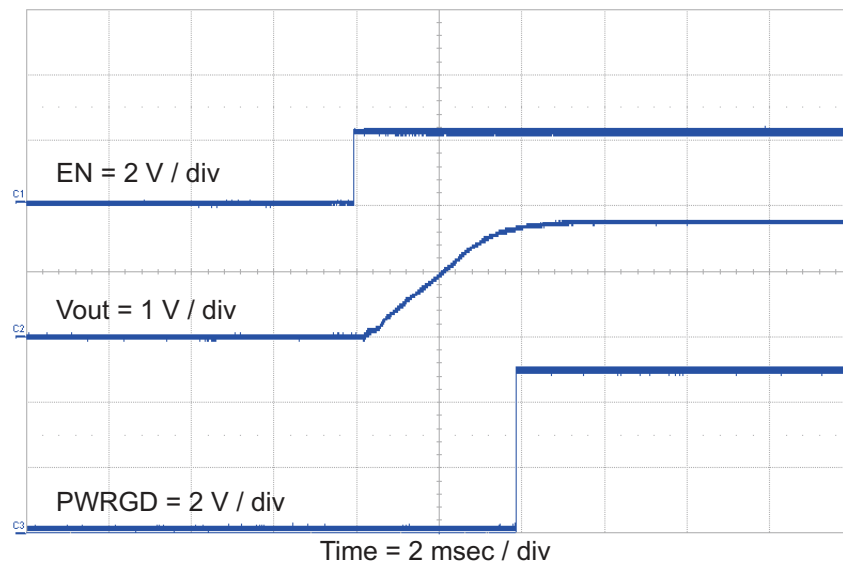

Figure 10. TPS54618EVM-606 Start-Up Relative to Enable

3 Board Layout

This section provides a description of the TPS54618EVM-606, board layout, and layer illustrations.

3.1 Layout

Figure 11 through Figure 15 show the board layout for the TPS54618EVM-606. The top-side layer of the EVM is laid out in a manner typical of a user application. The top, bottom, and internal layers are 2-oz. copper.

The top layer contains the main power traces for V_{IN} , V_{OUT} , and V_{PHASE} . Also on the top layer are connections for the remaining pins of the TPS54618 and a large area filled with ground. The bottom and internal layers contain ground planes only. The top-side ground areas are connected to the bottom and internal ground planes with multiple vias placed around the board including four vias directly under the TPS54618 device to provide a thermal path from the top-side ground area to the bottom-side and internal ground planes.

The input decoupling capacitors (C2, C3, and C4) and bootstrap capacitor (C8) are all located as close to the IC as possible. In addition, the voltage set-point resistor divider components are also located close to the IC. The voltage divider network ties to the output voltage at the point of regulation, the copper V_{OUT} trace near the output connector J3. For the TPS54618, an additional input bulk capacitor may be required, depending on the EVM connection to the input supply.

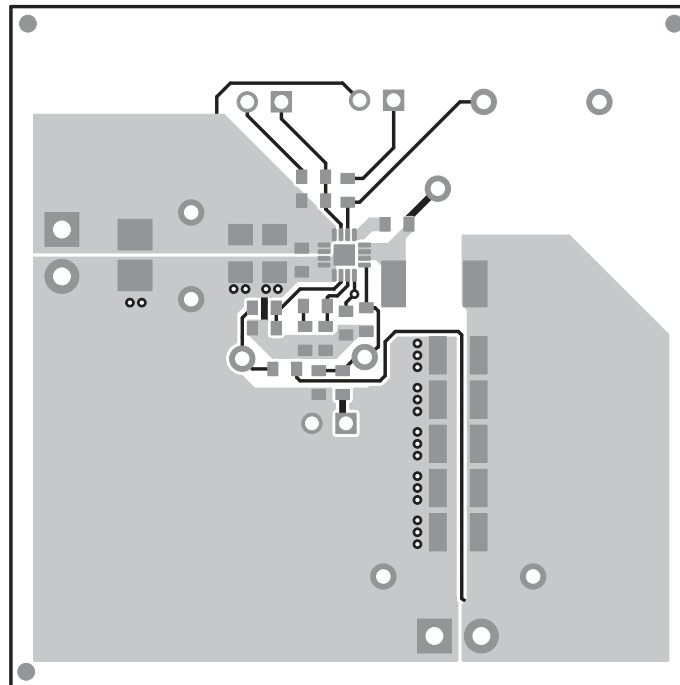

Figure 11. TPS54618EVM-606 Top-Side Layout

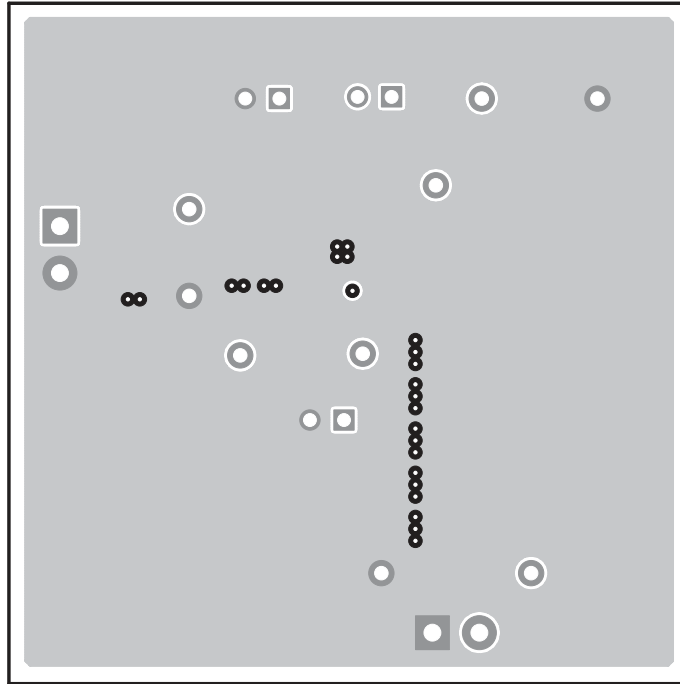

Figure 12. TPS54618EVM-606 Bottom-Side Layout

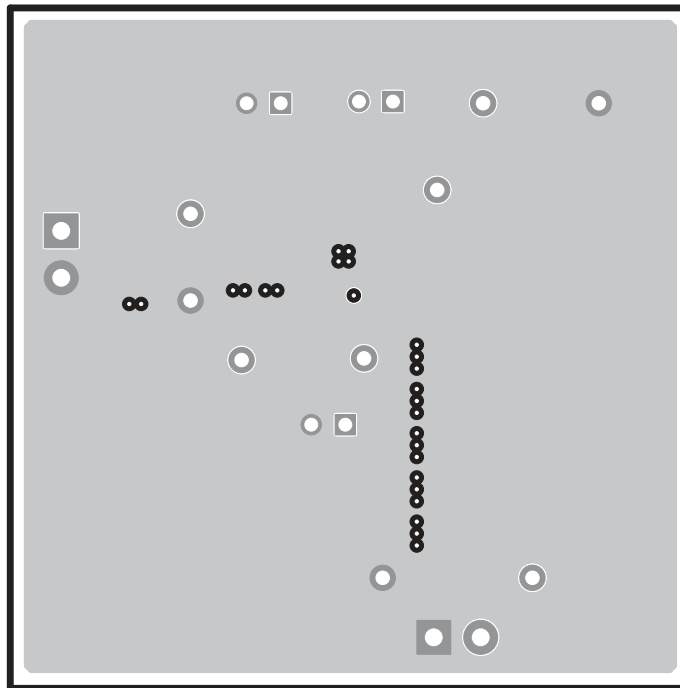

Figure 13. TPS54618EVM-606 Internal Layer 1

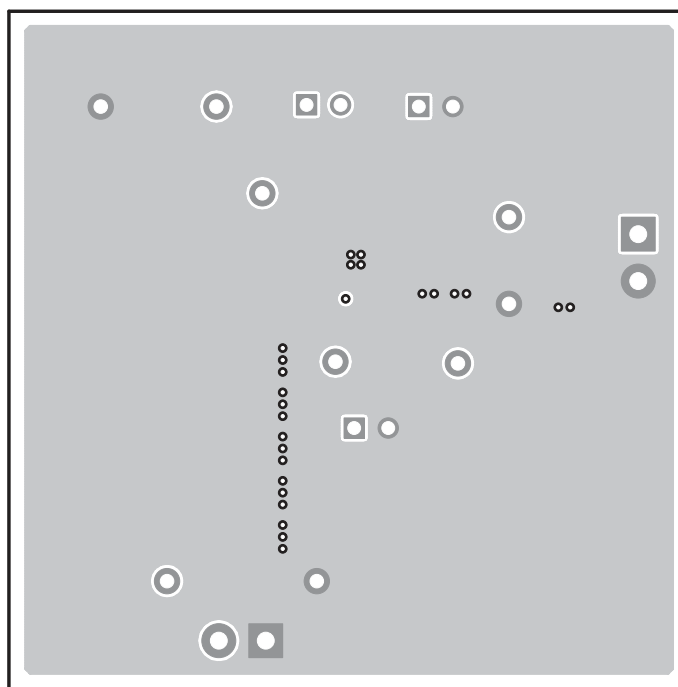

Figure 14. TPS54618EVM-606 Internal Layer 2

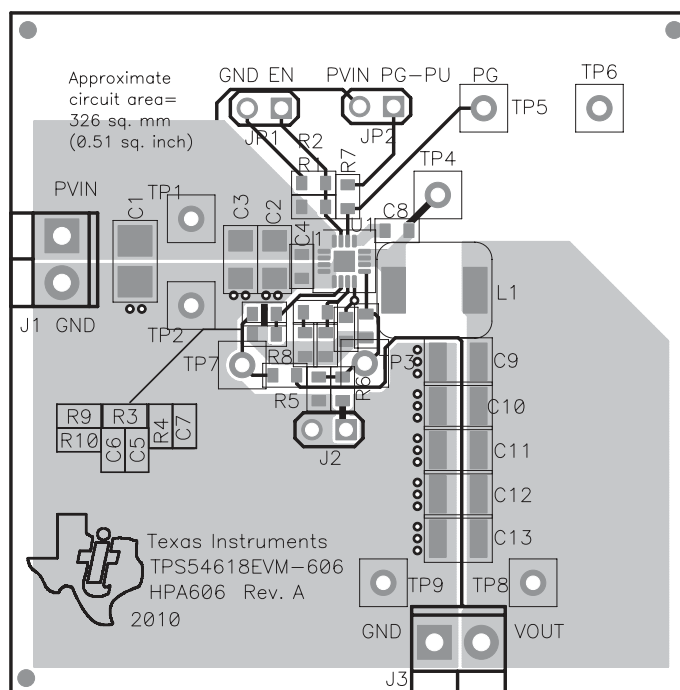

Figure 15. TPS54618EVM-606 Top-Side Assembly

3.2 Estimated Circuit Area

The estimated PCB area for the components used in this design is 0.51 in² (326 mm²). This area does not include test points or connectors.

4 Schematic and Bill of Materials

This section presents the TPS54618EVM-606 schematic and bill of materials.

4.1 Schematic

Figure 16 is the schematic for the TPS54618EVM-606.

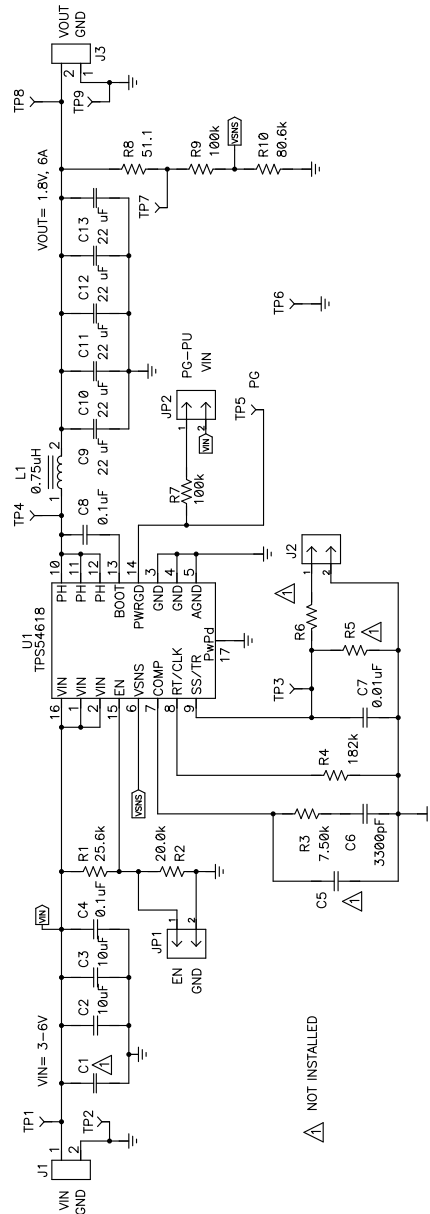

Figure 16. TPS54618EVM-606 Schematic

4.2 Bill of Materials

Table 5 presents the bill of materials for the TPS54618EVM-606.

Table 5. TPS54618EVM-606 Bill of Materials

Count	RefDes	Value	Description	Size	Part Number	MFR
0	C1	Open	Capacitor, Ceramic	Multi sizes	Engineering Only	Std
2	C2, C3	10 μ F	Capacitor, Ceramic, 10 V, X5R, 20%	1206	Std	Std
2	C4, C8	0.1 μ F	Capacitor, Ceramic, 25 V, X5R, 10%	0603	Std	Std
0	C5	Open	Capacitor, Ceramic	0603	Std	Std
1	C6	3300 pF	Capacitor, Ceramic, 50 V, X7R, 10%	0603	Std	Std
1	C7	0.01 μ F	Capacitor, Ceramic, 16 V, X7R, 15%	0603	Std	Std
5	C9, C10, C11, C12, C13	22 μ F	Capacitor, Ceramic, 10 V, X5R, 20%	1210	Std	Std
2	J1, J3	ED555/2DS	Terminal Block, 2-pin, 6 A, 3.5 mm	0.27 x 0.25 inch	ED555/2DS	OST
3	JP1,JP 2, JP3	PEC02SAAN	Header, Male 2-pin, 100 mil spacing	0.100 inch x 2	PEC02SAAN	Sullins
1	L1	0.75 μ H	Inductor, SMT, 10 A, 7.5 m Ω	0.255 x 0.270 inch	FDV0630-R75M	TOKO
1	R1	25.6 k	Resistor, Chip, 1/16W, 1%	0603	Std	Std
1	R2	20.0 k	Resistor, Chip, 1/16W, 1%	0603	Std	Std
1	R3	7.50 k	Resistor, Chip, 1/16W, 1%	0603	Std	Std
1	R4	182 k	Resistor, Chip, 1/16W, 1%	0603	Std	Std
0	R5, R6	Open	Resistor, Chip, 1/16W, 1%	0603	Std	Std
2	R7, R9	100 k	Resistor, Chip, 1/16W, 1%	0603	Std	Std
1	R8	51.1	Resistor, Chip, 1/16W, 1%	0603	Std	Std
1	R10	80.6 k	Resistor, Chip, 1/16W, 1%	0603	Std	Std
7	TP1, TP3, TP4, TP5, TP6,TP 7,TP8	5000	Test Point, Red, Thru Hole Color Keyed	0.100 x 0.100 inch	5000	Keystone
2	TP2, TP9	5001	Test Point, Black, Thru Hole Color Keyed	0.100 x 0.100 inch	5001	Keystone
1	U1	TPS54618RTE	IC, DC-DC Converter, 2.95 V–6 V, 6 A	QFN-16	TPS54618RTE	TI
1	–		Shunt, 100-mil, Black	0.100	929950-00	3M
1	–		PCB, 2 in x 2 in x 0.062 in		HPA606	Any

- Notes 1. These assemblies are ESD sensitive, ESD precautions shall be observed.
2. These assemblies must be clean and free from flux and all contaminants. Use of no clean flux is not acceptable.
3. These assemblies must comply with workmanship standards IPC-A-610 Class 2.
4. Ref designators marked with an asterisk (***) cannot be substituted. All other components can be substituted with equivalent MFG's components.

EVALUATION BOARD/KIT/MODULE (EVM) ADDITIONAL TERMS

Texas Instruments (TI) provides the enclosed Evaluation Board/Kit/Module (EVM) under the following conditions:

The user assumes all responsibility and liability for proper and safe handling of the goods. Further, the user indemnifies TI from all claims arising from the handling or use of the goods.

Should this evaluation board/kit not meet the specifications indicated in the User's Guide, the board/kit may be returned within 30 days from the date of delivery for a full refund. THE FOREGOING LIMITED WARRANTY IS THE EXCLUSIVE WARRANTY MADE BY SELLER TO BUYER AND IS IN LIEU OF ALL OTHER WARRANTIES, EXPRESSED, IMPLIED, OR STATUTORY, INCLUDING ANY WARRANTY OF MERCHANTABILITY OR FITNESS FOR ANY PARTICULAR PURPOSE. EXCEPT TO THE EXTENT OF THE INDEMNITY SET FORTH ABOVE, NEITHER PARTY SHALL BE LIABLE TO THE OTHER FOR ANY INDIRECT, SPECIAL, INCIDENTAL, OR CONSEQUENTIAL DAMAGES.

Please read the User's Guide and, specifically, the Warnings and Restrictions notice in the User's Guide prior to handling the product. This notice contains important safety information about temperatures and voltages. For additional information on TI's environmental and/or safety programs, please visit www.ti.com/esh or contact TI.

No license is granted under any patent right or other intellectual property right of TI covering or relating to any machine, process, or combination in which such TI products or services might be or are used. TI currently deals with a variety of customers for products, and therefore our arrangement with the user is not exclusive. TI assumes no liability for applications assistance, customer product design, software performance, or infringement of patents or services described herein.

REGULATORY COMPLIANCE INFORMATION

As noted in the EVM User's Guide and/or EVM itself, this EVM and/or accompanying hardware may or may not be subject to the Federal Communications Commission (FCC) and Industry Canada (IC) rules.

For EVMs **not** subject to the above rules, this evaluation board/kit/module is intended for use for ENGINEERING DEVELOPMENT, DEMONSTRATION OR EVALUATION PURPOSES ONLY and is not considered by TI to be a finished end product fit for general consumer use. It generates, uses, and can radiate radio frequency energy and has not been tested for compliance with the limits of computing devices pursuant to part 15 of FCC or ICES-003 rules, which are designed to provide reasonable protection against radio frequency interference. Operation of the equipment may cause interference with radio communications, in which case the user at his own expense will be required to take whatever measures may be required to correct this interference.

General Statement for EVMs including a radio

User Power/Frequency Use Obligations: This radio is intended for development/professional use only in legally allocated frequency and power limits. Any use of radio frequencies and/or power availability of this EVM and its development application(s) must comply with local laws governing radio spectrum allocation and power limits for this evaluation module. It is the user's sole responsibility to only operate this radio in legally acceptable frequency space and within legally mandated power limitations. Any exceptions to this are strictly prohibited and unauthorized by Texas Instruments unless user has obtained appropriate experimental/development licenses from local regulatory authorities, which is responsibility of user including its acceptable authorization.

For EVMs annotated as FCC – FEDERAL COMMUNICATIONS COMMISSION Part 15 Compliant

Caution

This device complies with part 15 of the FCC Rules. Operation is subject to the following two conditions: (1) This device may not cause harmful interference, and (2) this device must accept any interference received, including interference that may cause undesired operation.

Changes or modifications not expressly approved by the party responsible for compliance could void the user's authority to operate the equipment.

FCC Interference Statement for Class A EVM devices

This equipment has been tested and found to comply with the limits for a Class A digital device, pursuant to part 15 of the FCC Rules. These limits are designed to provide reasonable protection against harmful interference when the equipment is operated in a commercial environment. This equipment generates, uses, and can radiate radio frequency energy and, if not installed and used in accordance with the instruction manual, may cause harmful interference to radio communications. Operation of this equipment in a residential area is likely to cause harmful interference in which case the user will be required to correct the interference at his own expense.

FCC Interference Statement for Class B EVM devices

This equipment has been tested and found to comply with the limits for a Class B digital device, pursuant to part 15 of the FCC Rules. These limits are designed to provide reasonable protection against harmful interference in a residential installation. This equipment generates, uses and can radiate radio frequency energy and, if not installed and used in accordance with the instructions, may cause harmful interference to radio communications. However, there is no guarantee that interference will not occur in a particular installation. If this equipment does cause harmful interference to radio or television reception, which can be determined by turning the equipment off and on, the user is encouraged to try to correct the interference by one or more of the following measures:

- Reorient or relocate the receiving antenna.
- Increase the separation between the equipment and receiver.
- Connect the equipment into an outlet on a circuit different from that to which the receiver is connected.
- Consult the dealer or an experienced radio/TV technician for help.

For EVMs annotated as IC – INDUSTRY CANADA Compliant

This Class A or B digital apparatus complies with Canadian ICES-003.

Changes or modifications not expressly approved by the party responsible for compliance could void the user's authority to operate the equipment.

Concerning EVMs including radio transmitters

This device complies with Industry Canada licence-exempt RSS standard(s). Operation is subject to the following two conditions: (1) this device may not cause interference, and (2) this device must accept any interference, including interference that may cause undesired operation of the device.

Concerning EVMs including detachable antennas

Under Industry Canada regulations, this radio transmitter may only operate using an antenna of a type and maximum (or lesser) gain approved for the transmitter by Industry Canada. To reduce potential radio interference to other users, the antenna type and its gain should be so chosen that the equivalent isotropically radiated power (e.i.r.p.) is not more than that necessary for successful communication.

This radio transmitter has been approved by Industry Canada to operate with the antenna types listed in the user guide with the maximum permissible gain and required antenna impedance for each antenna type indicated. Antenna types not included in this list, having a gain greater than the maximum gain indicated for that type, are strictly prohibited for use with this device.

Cet appareil numérique de la classe A ou B est conforme à la norme NMB-003 du Canada.

Les changements ou les modifications pas expressément approuvés par la partie responsable de la conformité ont pu vider l'autorité de l'utilisateur pour actionner l'équipement.

Concernant les EVMs avec appareils radio

Le présent appareil est conforme aux CNR d'Industrie Canada applicables aux appareils radio exempts de licence. L'exploitation est autorisée aux deux conditions suivantes : (1) l'appareil ne doit pas produire de brouillage, et (2) l'utilisateur de l'appareil doit accepter tout brouillage radioélectrique subi, même si le brouillage est susceptible d'en compromettre le fonctionnement.

Concernant les EVMs avec antennes détachables

Conformément à la réglementation d'Industrie Canada, le présent émetteur radio peut fonctionner avec une antenne d'un type et d'un gain maximal (ou inférieur) approuvé pour l'émetteur par Industrie Canada. Dans le but de réduire les risques de brouillage radioélectrique à l'intention des autres utilisateurs, il faut choisir le type d'antenne et son gain de sorte que la puissance isotrope rayonnée équivalente (p.i.r.e.) ne dépasse pas l'intensité nécessaire à l'établissement d'une communication satisfaisante.

Le présent émetteur radio a été approuvé par Industrie Canada pour fonctionner avec les types d'antenne énumérés dans le manuel d'usage et ayant un gain admissible maximal et l'impédance requise pour chaque type d'antenne. Les types d'antenne non inclus dans cette liste, ou dont le gain est supérieur au gain maximal indiqué, sont strictement interdits pour l'exploitation de l'émetteur.

【Important Notice for Users of this Product in Japan】

This development kit is NOT certified as Confirming to Technical Regulations of Radio Law of Japan

If you use this product in Japan, you are required by Radio Law of Japan to follow the instructions below with respect to this product:

1. Use this product in a shielded room or any other test facility as defined in the notification #173 issued by Ministry of Internal Affairs and Communications on March 28, 2006, based on Sub-section 1.1 of Article 6 of the Ministry's Rule for Enforcement of Radio Law of Japan,
2. Use this product only after you obtained the license of Test Radio Station as provided in Radio Law of Japan with respect to this product, or
3. Use of this product only after you obtained the Technical Regulations Conformity Certification as provided in Radio Law of Japan with respect to this product. Also, please do not transfer this product, unless you give the same notice above to the transferee. Please note that if you could not follow the instructions above, you will be subject to penalties of Radio Law of Japan.

Texas Instruments Japan Limited
(address) 24-1, Nishi-Shinjuku 6 chome, Shinjuku-ku, Tokyo, Japan

<http://www.tij.co.jp>

【ご使用にあたっての注】

本開発キットは技術基準適合証明を受けておりません。

本製品のご使用に際しては、電波法遵守のため、以下のいずれかの措置を取っていただく必要がありますのでご注意ください。

1. 電波法施行規則第6条第1項第1号に基づく平成18年3月28日総務省告示第173号で定められた電波暗室等の試験設備でご使用いただく。
2. 実験局の免許を取得後ご使用いただく。
3. 技術基準適合証明を取得後ご使用いただく。

なお、本製品は、上記の「ご使用にあたっての注意」を譲渡先、移転先に通知しない限り、譲渡、移転できないものとします。

上記を遵守頂けない場合は、電波法の罰則が適用される可能性があることをご留意ください。

日本テキサス・インスツルメンツ株式会社
東京都新宿区西新宿6丁目24番1号
西新宿三井ビル

<http://www.tij.co.jp>

EVALUATION BOARD/KIT/MODULE (EVM) WARNINGS, RESTRICTIONS AND DISCLAIMERS

For Feasibility Evaluation Only, in Laboratory/Development Environments. Unless otherwise indicated, this EVM is not a finished electrical equipment and not intended for consumer use. It is intended solely for use for preliminary feasibility evaluation in laboratory/development environments by technically qualified electronics experts who are familiar with the dangers and application risks associated with handling electrical mechanical components, systems and subsystems. It should not be used as all or part of a finished end product.

Your Sole Responsibility and Risk. You acknowledge, represent and agree that:

1. You have unique knowledge concerning Federal, State and local regulatory requirements (including but not limited to Food and Drug Administration regulations, if applicable) which relate to your products and which relate to your use (and/or that of your employees, affiliates, contractors or designees) of the EVM for evaluation, testing and other purposes.
2. You have full and exclusive responsibility to assure the safety and compliance of your products with all such laws and other applicable regulatory requirements, and also to assure the safety of any activities to be conducted by you and/or your employees, affiliates, contractors or designees, using the EVM. Further, you are responsible to assure that any interfaces (electronic and/or mechanical) between the EVM and any human body are designed with suitable isolation and means to safely limit accessible leakage currents to minimize the risk of electrical shock hazard.
3. You will employ reasonable safeguards to ensure that your use of the EVM will not result in any property damage, injury or death, even if the EVM should fail to perform as described or expected.
4. You will take care of proper disposal and recycling of the EVM's electronic components and packing materials.

Certain Instructions. It is important to operate this EVM within TI's recommended specifications and environmental considerations per the user guidelines. Exceeding the specified EVM ratings (including but not limited to input and output voltage, current, power, and environmental ranges) may cause property damage, personal injury or death. If there are questions concerning these ratings please contact a TI field representative prior to connecting interface electronics including input power and intended loads. Any loads applied outside of the specified output range may result in unintended and/or inaccurate operation and/or possible permanent damage to the EVM and/or interface electronics. Please consult the EVM User's Guide prior to connecting any load to the EVM output. If there is uncertainty as to the load specification, please contact a TI field representative. During normal operation, some circuit components may have case temperatures greater than 60°C as long as the input and output are maintained at a normal ambient operating temperature. These components include but are not limited to linear regulators, switching transistors, pass transistors, and current sense resistors which can be identified using the EVM schematic located in the EVM User's Guide. When placing measurement probes near these devices during normal operation, please be aware that these devices may be very warm to the touch. As with all electronic evaluation tools, only qualified personnel knowledgeable in electronic measurement and diagnostics normally found in development environments should use these EVMs.

Agreement to Defend, Indemnify and Hold Harmless. You agree to defend, indemnify and hold TI, its licensors and their representatives harmless from and against any and all claims, damages, losses, expenses, costs and liabilities (collectively, "Claims") arising out of or in connection with any use of the EVM that is not in accordance with the terms of the agreement. This obligation shall apply whether Claims arise under law of tort or contract or any other legal theory, and even if the EVM fails to perform as described or expected.

Safety-Critical or Life-Critical Applications. If you intend to evaluate the components for possible use in safety critical applications (such as life support) where a failure of the TI product would reasonably be expected to cause severe personal injury or death, such as devices which are classified as FDA Class III or similar classification, then you must specifically notify TI of such intent and enter into a separate Assurance and Indemnity Agreement.

Mailing Address: Texas Instruments, Post Office Box 655303, Dallas, Texas 75265
Copyright © 2012, Texas Instruments Incorporated

IMPORTANT NOTICE

Texas Instruments Incorporated and its subsidiaries (TI) reserve the right to make corrections, modifications, enhancements, improvements, and other changes to its products and services at any time and to discontinue any product or service without notice. Customers should obtain the latest relevant information before placing orders and should verify that such information is current and complete. All products are sold subject to TI's terms and conditions of sale supplied at the time of order acknowledgment.

TI warrants performance of its hardware products to the specifications applicable at the time of sale in accordance with TI's standard warranty. Testing and other quality control techniques are used to the extent TI deems necessary to support this warranty. Except where mandated by government requirements, testing of all parameters of each product is not necessarily performed.

TI assumes no liability for applications assistance or customer product design. Customers are responsible for their products and applications using TI components. To minimize the risks associated with customer products and applications, customers should provide adequate design and operating safeguards.

TI does not warrant or represent that any license, either express or implied, is granted under any TI patent right, copyright, mask work right, or other TI intellectual property right relating to any combination, machine, or process in which TI products or services are used. Information published by TI regarding third-party products or services does not constitute a license from TI to use such products or services or a warranty or endorsement thereof. Use of such information may require a license from a third party under the patents or other intellectual property of the third party, or a license from TI under the patents or other intellectual property of TI.

Reproduction of TI information in TI data books or data sheets is permissible only if reproduction is without alteration and is accompanied by all associated warranties, conditions, limitations, and notices. Reproduction of this information with alteration is an unfair and deceptive business practice. TI is not responsible or liable for such altered documentation. Information of third parties may be subject to additional restrictions.

Resale of TI products or services with statements different from or beyond the parameters stated by TI for that product or service voids all express and any implied warranties for the associated TI product or service and is an unfair and deceptive business practice. TI is not responsible or liable for any such statements.

TI products are not authorized for use in safety-critical applications (such as life support) where a failure of the TI product would reasonably be expected to cause severe personal injury or death, unless officers of the parties have executed an agreement specifically governing such use. Buyers represent that they have all necessary expertise in the safety and regulatory ramifications of their applications, and acknowledge and agree that they are solely responsible for all legal, regulatory and safety-related requirements concerning their products and any use of TI products in such safety-critical applications, notwithstanding any applications-related information or support that may be provided by TI. Further, Buyers must fully indemnify TI and its representatives against any damages arising out of the use of TI products in such safety-critical applications.

TI products are neither designed nor intended for use in military/aerospace applications or environments unless the TI products are specifically designated by TI as military-grade or "enhanced plastic." Only products designated by TI as military-grade meet military specifications. Buyers acknowledge and agree that any such use of TI products which TI has not designated as military-grade is solely at the Buyer's risk, and that they are solely responsible for compliance with all legal and regulatory requirements in connection with such use.

TI products are neither designed nor intended for use in automotive applications or environments unless the specific TI products are designated by TI as compliant with ISO/TS 16949 requirements. Buyers acknowledge and agree that, if they use any non-designated products in automotive applications, TI will not be responsible for any failure to meet such requirements.

Following are URLs where you can obtain information on other Texas Instruments products and application solutions:

Products

Audio	www.ti.com/audio
Amplifiers	amplifier.ti.com
Data Converters	dataconverter.ti.com
DLP® Products	www.dlp.com
DSP	dsp.ti.com
Clocks and Timers	www.ti.com/clocks
Interface	interface.ti.com
Logic	logic.ti.com
Power Mgmt	power.ti.com
Microcontrollers	microcontroller.ti.com
RFID	www.ti-rfid.com
OMAP Mobile Processors	www.ti.com/omap
Wireless Connectivity	www.ti.com/wirelessconnectivity

Applications

Automotive and Transportation	www.ti.com/automotive
Communications and Telecom	www.ti.com/communications
Computers and Peripherals	www.ti.com/computers
Consumer Electronics	www.ti.com/consumer-apps
Energy and Lighting	www.ti.com/energy
Industrial	www.ti.com/industrial
Medical	www.ti.com/medical
Security	www.ti.com/security
Space, Avionics and Defense	www.ti.com/space-avionics-defense
Video and Imaging	www.ti.com/video

TI E2E Community Home Page

e2e.ti.com

Mailing Address: Texas Instruments, Post Office Box 655303, Dallas, Texas 75265
Copyright © 2012, Texas Instruments Incorporated