

Description:

The X4C40L1-05G is a low profile, high performance 5dB 90° coupler in a new easy to use, manufacturing friendly surface mount package. It is designed for 5G applications. The X4C40L1-05G is available on tape and reel for pick and place high volume manufacturing.

All of the Xinger components are constructed from ceramic filled PTFE composites, which possess excellent electrical and mechanical stability. All parts have been subjected to rigorous qualification testing and units are 100% RF tested. Produced in an ENIG final finish.

Electrical Specifications**

Features:

- 3100-5100 MHz
- 5G Applications
- Very Low Loss
- Tight Coupling
- High Isolation
- Production Friendly
- Tape and Reel
- RoHS Compliant
- Halogen Free

Frequency	Coupling	Insertion Loss	Return Loss
<i>MHz</i>	<i>dB</i>	<i>dB Max</i>	<i>dB Min</i>
3100-3700	5 ± 0.5	0.5	20
3700-5100	5 ± 0.6	0.5	18
Isolation	Phase Balance	Power	Operating Temp.
<i>dB Min</i>	<i>Degrees</i>	<i>Avg. CW Watts @105 °C</i>	<i>°C</i>
23	90 ±4.0	3*	-55 to +140
23	90 ±4.5	3*	-55 to +140

**Specification based on performance of unit properly installed on TTM Test Board with small signal applied.
*Specifications subject to change without notice. Refer to parameter definitions for details.

Mechanical Outline:

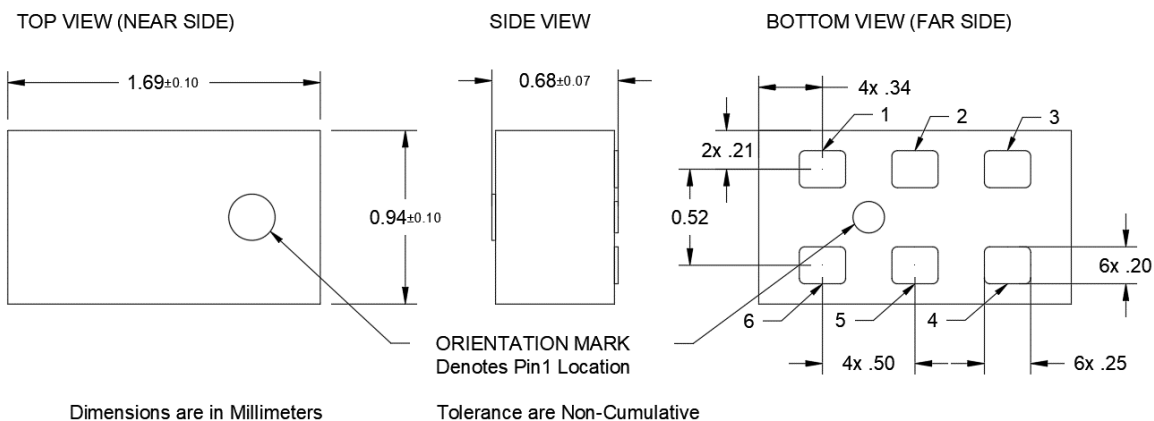

Directional Coupler Pin Configuration:

The X4C40L1-05G has an orientation marker to denote Pin 1. Once port one has been identified, the other ports are known automatically. Please see the chart below for clarification:

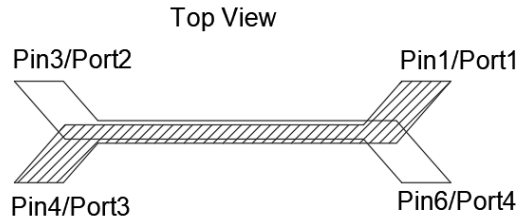

0603 size 5dB Coupler Pin Configuration

Configuration	Pin1/Port 1	Pin 2	Pin 3/Port2	Pin 4/Port3	Pin 5	Pin 6/Port4
Splitter	Input	GND	Isolated	$-2\text{dB}\angle\theta - 90$	GND	$-5\text{dB}\angle\theta$
Splitter	Isolated	GND	Input	$-5\text{dB}\angle\theta$	GND	$-2\text{dB}\angle\theta - 90$
Splitter	$-2\text{dB}\angle\theta - 90$	GND	$-5\text{dB}\angle\theta$	Input	GND	Isolated
Splitter	$-5\text{dB}\angle\theta$	GND	$-2\text{dB}\angle\theta - 90$	Isolated	GND	Input

Note: The direct port has a DC connection to the input port and the coupled port has a DC connection to the isolated port. For optimum IL and power handling performance, use Pin 1 or Pin 4 as inputs.

Peak Power Handling:

High-POT testing of these components during the qualification procedure resulted in a minimum breakdown voltage of 1Kv (minimum recorded value). This voltage level corresponds to a breakdown resistance capable of handling at least 12dB peaks over average power levels, for very short durations. The breakdown location consistently occurred across the pads and the ground bar (see illustration below). The breakdown levels at these points will be affected by any contamination in the gap area around these pads. These areas must be kept clean for optimum performance. It is recommended that the user test for voltage breakdown under the maximum operating conditions and over worst case modulation induced power peaking. This evaluation should also include extreme environmental conditions (such as high humidity).

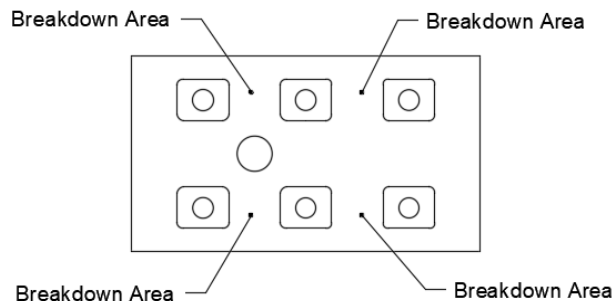

Insertion Loss and Power Derating Curves

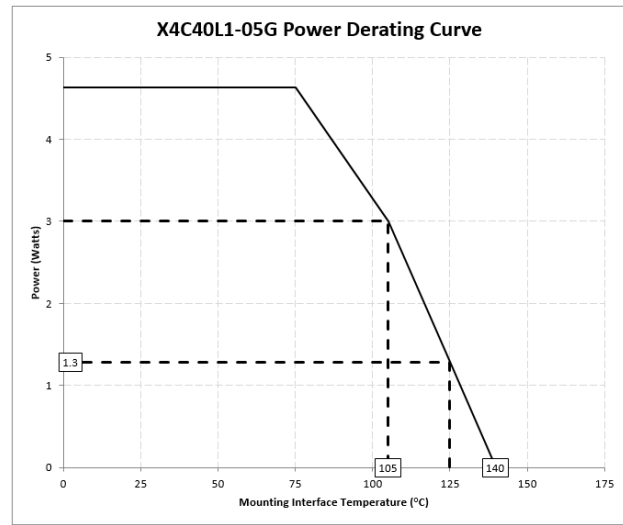
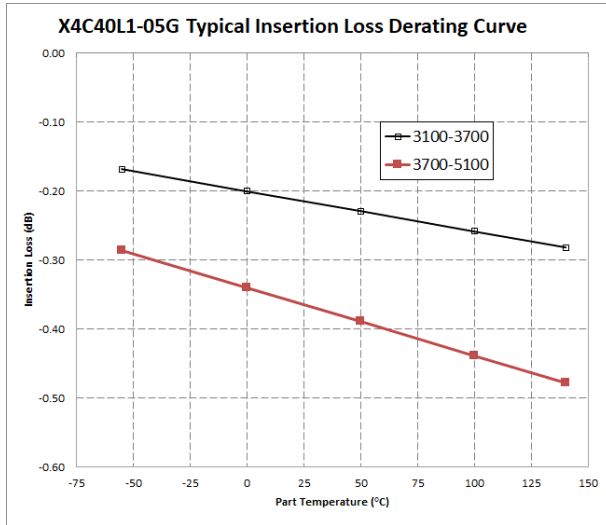

Insertion Loss Derating

The insertion loss, at a given frequency, of a group of couplers is measured at 25°C and then averaged. The measurements are performed under small signal conditions (i.e. using a Vector Network Analyzer). The process is repeated at -55°C, 105°C and 140°C. A best-fit line for the measured data is computed and then plotted from -55°C to 140°C.

Power Derating

The power handling and corresponding power derating plots are a function of the thermal resistance, mounting surface temperature (base plate temperature), maximum continuous operating temperature of the coupler, and the thermal insertion loss. The thermal insertion loss is defined in the Power Handling section of the data sheet.

As the mounting interface temperature approaches the maximum continuous operating temperature, the power handling decreases to zero.

If mounting temperature is greater than 105°C, Xinger coupler will perform reliably as long as the input power is derated to the curve above.

Typical Performance: 2500 MHz to 5500 MHz at -55, 25, 105 and 140°C

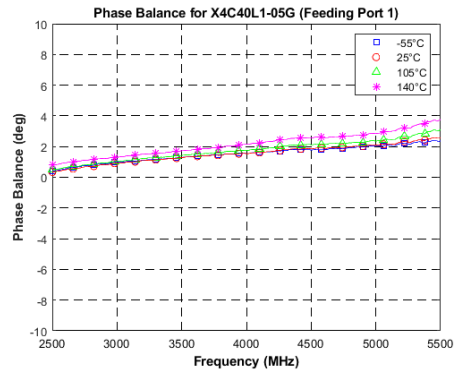
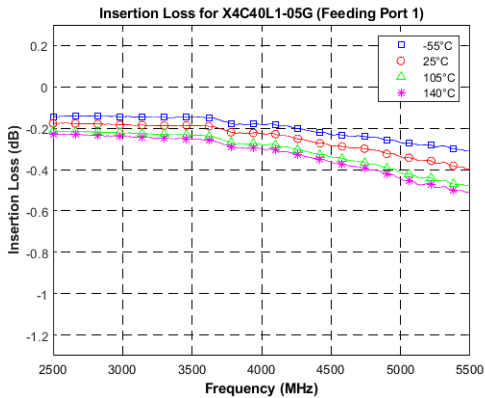
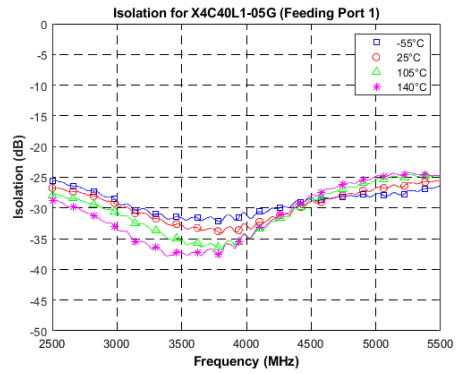
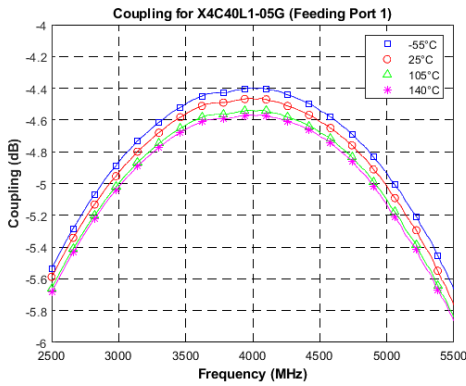
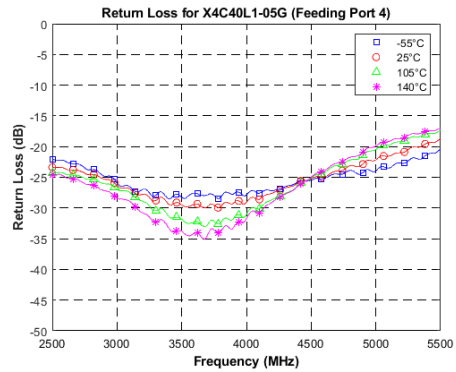
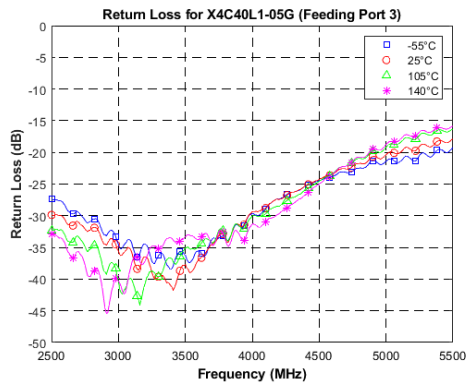
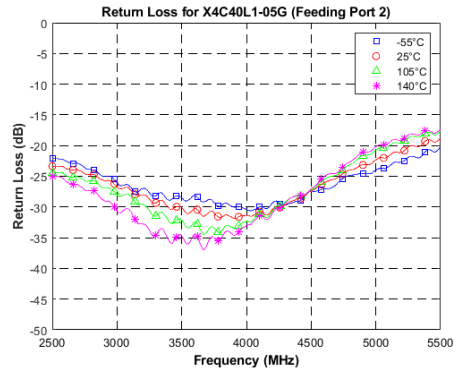
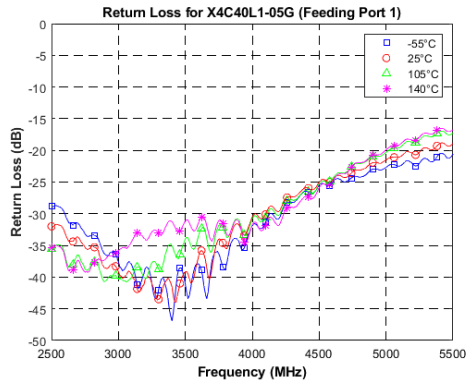

Definition of Measured Specifications:

Parameter	Definition	Mathematical Representation
VSWR (Voltage Standing Wave Ratio)	The impedance match of the coupler to a 50Ω system. A VSWR of 1:1 is optimal.	$VSWR = \frac{V_{max}}{V_{min}}$ Vmax = voltage maxima of a standing wave Vmin = voltage minima of a standing wave
Return Loss	The impedance match of the coupler to a 50Ω system. Return Loss is an alternate means to express VSWR.	$Return\ Loss(dB) = 20\log \frac{VSWR + 1}{VSWR - 1}$
Insertion Loss	The input power divided by the sum of the power at the two output ports.	$Insertion\ Loss(dB) = 10\log \frac{P_{in}}{P_{cpl} + P_{direct}}$
Isolation	The input power divided by the power at the isolated port.	$Isolation(dB) = 10\log \frac{P_{in}}{P_{iso}}$
Phase Balance	The difference in phase angle between the two output ports.	Phase at coupled port - Phase at direct port
Coupling	At a given frequency (ω_n), coupling is the input power divided by the power at the coupled port.	$Coupling(dB) = C(\omega_n) = 10\log \frac{P_{in}(\omega_n)}{P_{cpl}(\omega_n)}$
Group Delay	Group delay is average of group delay's from input port to the coupled port	Average (GD-C)

Packaging and Ordering Information:

Parts are available in reel and are packaged per EIA 481. Parts are oriented in tape and reel as shown below. Minimum order quantities are 4000 per reel.

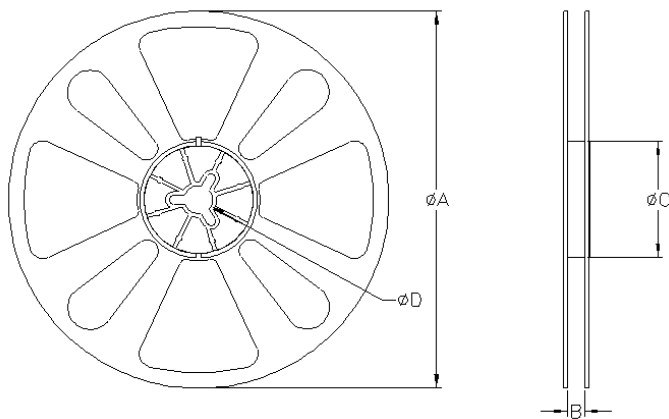
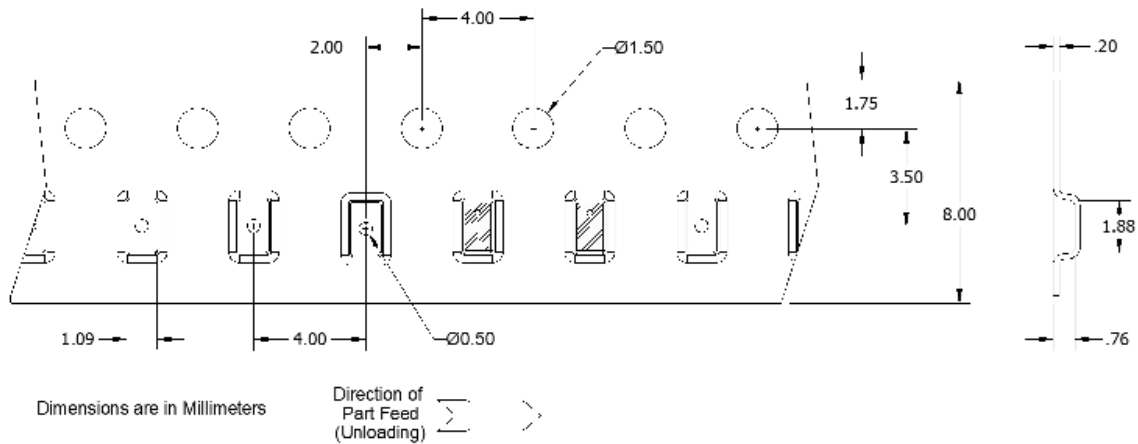

TABLE 1		
QUANTITY/REEL	REEL DIMENSIONS mm	
4000	ØA	177.80
	B	8.00
	ØC	50.80
	ØD	13.00

Contact us:
rf&s_support@ttm.com