

National Semiconductor is now part of
Texas Instruments.

Search <http://www.ti.com/> for the latest technical
information and details on our current products and services.

LMH6654/LMH6655

Single/Dual Low Power, 250 MHz, Low Noise Amplifiers

General Description

The LMH6654/LMH6655 single and dual high speed, voltage feedback amplifiers are designed to have unity-gain stable operation with a bandwidth of 250 MHz. They operate from $\pm 2.5V$ to $\pm 6V$ and each channel consumes only 4.5 mA. The amplifiers feature very low voltage noise and wide output swing to maximize signal-to-noise ratio.

The LMH6654/LMH6655 have a true single supply capability with input common mode voltage range extending 150 mV below negative rail and within 1.3V of the positive rail.

LMH6654/LMH6655 high speed and low power combination make these products an ideal choice for many portable, high speed application where power is at a premium.

The LMH6654 is packaged in 5-Pin SOT-23 and 8-Pin SOIC. The LMH6655 is packaged in 8-Pin MSOP and 8-Pin SOIC.

The LMH6654/LMH6655 are built on National's Advance VIP10™ (Vertically Integrated PNP) complementary bipolar process.

Features

($V_S = \pm 5V$, $T_J = 25^\circ C$, Typical values unless specified).

- Voltage feedback architecture
- Unity gain bandwidth 250 MHz
- Supply voltage range $\pm 2.5V$ to $\pm 6V$
- Slew rate 200 V/ μ sec
- Supply current 4.5 mA/channel
- Input common mode voltage $-5.15V$ to $+3.7V$
- Output voltage swing ($R_L = 100\Omega$) $-3.6V$ to $3.4V$
- Input voltage noise 4.5 nV/ \sqrt{Hz}
- Input current noise 1.7 pA/ \sqrt{Hz}
- Settling Time to 0.01% 25 ns

Applications

- ADC drivers
- Consumer video
- Active filters
- Pulse delay circuits
- xDSL receiver
- Pre-amps

Typical Performance Characteristics

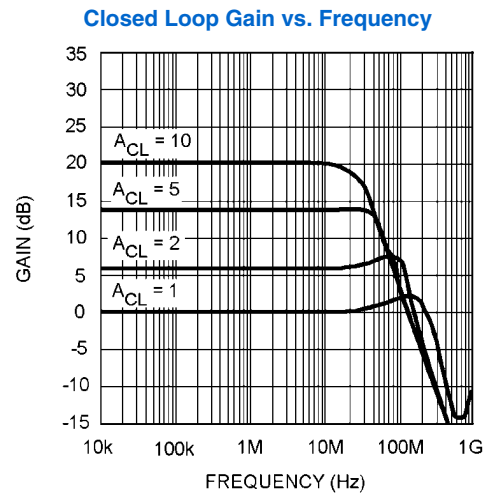
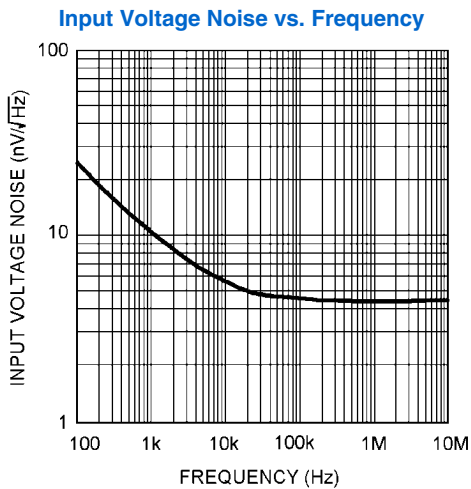

VIP10™ is a trademark of National Semiconductor Corporation.

Absolute Maximum Ratings (Note 1)

If Military/Aerospace specified devices are required, please contact the National Semiconductor Sales Office/Distributors for availability and specifications.

ESD Tolerance (Note 2)	
Human Body Model	2 kV
Machine Model	200V
V _{IN} Differential	±1.2V
Output Short Circuit Duration	(Note 3)
Supply Voltage (V ₊ - V ₋)	13.2V
Voltage at Input pins	V ₊ +0.5V, V ₋ -0.5V
Storage Temperature Range	-65°C to +150°C

Junction Temperature (Note 4)	+150°C
Soldering Information	
Infrared or Convection (20 sec.)	235°C
Wave Soldering (10 sec.)	260°C

Operating Ratings (Note 1)

Supply Voltage (V ₊ - V ₋)	±2.5V to ±6.0V
Junction Temperature Range	-40°C to +85°C
Thermal Resistance (θ _{JA})	
8-Pin SOIC	172°C/W
8-Pin MSOP	235°C/W
5-Pin SOT-23	265°C/W

±5V Electrical Characteristics

Unless otherwise specified, all limits guaranteed for T_J = 25°C, V₊ = +5V, V₋ = -5V, V_{CM} = 0V, A_V = +1, R_F = 25Ω for gain = +1, R_F = 402Ω for gain = ≥ +2, and R_L = 100Ω. **Boldface** limits apply at the temperature extremes.

Symbol	Parameter	Conditions	Min (Note 6)	Typ (Note 5)	Max (Note 6)	Units
Dynamic Performance						
f _{CL}	Close Loop Bandwidth	A _V = +1		250		MHz
		A _V = +2		130		
		A _V = +5		52		
		A _V = +10		26		
GBWP	Gain Bandwidth Product	A _V ≥ +5		260		MHz
	Bandwidth for 0.1 dB Flatness	A _V +1		18		MHz
φ _m	Phase Margin			50		deg
SR	Slew Rate (Note 8)	A _V = +1, V _{IN} = 2 V _{PP}		200		V/μs
t _S	Settling Time 0.01%	A _V = +1, 2V Step		25		ns
				15		ns
t _r	Rise Time	A _V = +1, 0.2V Step		1.4		ns
t _f	Fall Time	A _V = +1, 0.2V Step		1.2		ns
Distortion and Noise Response						
e _n	Input Referred Voltage Noise	f ≥ 0.1 MHz		4.5		nV/√Hz
i _n	Input-Referred Current Noise	f ≥ 0.1 MHz		1.7		pA/√Hz
	Second Harmonic Distortion	A _V = +1, f = 5 MHz		-80		dBc
	Third Harmonic Distortion	V _O = 2 V _{PP} , R _L = 100Ω		-85		
X _t	Crosstalk (for LMH6655 only)	Input Referred, 5 MHz, Channel-to-Channel		-80		dB
DG	Differential Gain	A _V = +2, NTSC, R _L = 150Ω		0.01		%
DP	Differential Phase	A _V = +2, NTSC, R _L = 150Ω		0.025		deg
Input Characteristics						
V _{OS}	Input Offset Voltage	V _{CM} = 0V	-3 -4	±1	3 4	mV
TC V _{OS}	Input Offset Average Drift	V _{CM} = 0V (Note 7)		6		μV/°C
I _B	Input Bias Current	V _{CM} = 0V		5	12 18	μA
I _{OS}	Input Offset Current	V _{CM} = 0V	-1 -2	0.3	1 2	μA
R _{IN}	Input Resistance	Common Mode		4		MΩ
		Differential Mode		20		kΩ

Symbol	Parameter	Conditions	Min (Note 6)	Typ (Note 5)	Max (Note 6)	Units
C_{IN}	Input Capacitance	Common Mode		1.8		pF
		Differential Mode		1		
CMRR	Common Mode Rejection Ratio	Input Referred, $V_{CM} = 0V$ to $-5V$	70 68	90		dB
CMVR	Input Common- Mode Voltage Range	CMRR ≥ 50 dB		-5.15	-5.0	V
				3.5	3.7	
Transfer Characteristics						
A_{VOL}	Large Signal Voltage Gain	$V_O = 4 V_{PP}, R_L = 100\Omega$	60 58	67		dB
Output Characteristics						
V_O	Output Swing High	No Load	3.4 3.2	3.6		V
	Output Swing Low	No Load		-3.9	-3.7 -3.5	
	Output Swing High	$R_L = 100\Omega$	3.2 3.0	3.4		
	Output Swing Low	$R_L = 100\Omega$		-3.6	-3.4 -3.2	
I_{SC}	Short Circuit Current (Note 3)	Sourcing, $V_O = 0V$ $\Delta V_{IN} = 200$ mV	145 130	280		mA
		Sinking, $V_O = 0V$ $\Delta V_{IN} = 200$ mV	100 80	185		
I_{OUT}	Output Current	Sourcing, $V_O = +3V$		80		mA
		Sinking, $V_O = -3V$		120		
R_O	Output Resistance	$A_V = +1, f < 100$ kHz		0.08		Ω
Power Supply						
PSRR	Power Supply Rejection Ratio	Input Referred, $V_S = \pm 5V$ to $\pm 6V$	60	76		dB
I_S	Supply Current (per channel)			4.5	6 7	mA
5V Electrical Characteristics						
Unless otherwise specified, all limits guaranteed for $T_J = 25^\circ C$, $V^+ = +5V$, $V^- = -0V$, $V_{CM} = 2.5V$, $A_V = +1$, $R_F = 25\Omega$ for gain = +1, $R_F = 402\Omega$ for gain = $\geq +2$, and $R_L = 100\Omega$ to $V^+/2$. Boldface limits apply at the temperature extremes.						
Symbol	Parameter	Conditions	Min (Note 6)	Typ (Note 5)	Max (Note 6)	Units
Dynamic Performance						
f_{CL}	Close Loop Bandwidth	$A_V = +1$		230		MHz
		$A_V = +2$		120		
		$A_V = +5$		50		
		$A_V = +10$		25		
GBWP	Gain Bandwidth Product	$A_V \geq +5$		250		MHz
	Bandwidth for 0.1 dB Flatness	$A_V = +1$		17		MHz
ϕ_m	Phase Margin			48		deg
SR	Slew Rate (Note 8)	$A_V = +1, V_{IN} = 2 V_{PP}$		190		V/ μs
t_S	Settling Time	$A_V = +1, 2V$ Step	0.01%		30	ns
			0.1%		20	ns
t_r	Rise Time	$A_V = +1, 0.2V$ Step		1.5		ns
t_f	Fall Time	$A_V = +1, 0.2V$ Step		1.35		ns

Symbol	Parameter	Conditions	Min (Note 6)	Typ (Note 5)	Max (Note 6)	Units
Distortion and Noise Response						
e_n	Input Referred Voltage Noise	$f \geq 0.1$ MHz		4.5		nV/\sqrt{Hz}
i_n	Input Referred Current Noise	$f \geq 0.1$ MHz		1.7		pA/\sqrt{Hz}
	Second Harmonic Distortion	$A_V = +1, f = 5$ MHz		-65		dBc
	Third Harmonic Distortion	$V_O = 2 V_{PP}, R_L = 100\Omega$		-70		
X_t	Crosstalk (for LMH6655 only)	Input Referred, 5 MHz		-78		dB
Input Characteristics						
V_{OS}	Input Offset Voltage	$V_{CM} = 2.5V$	-5 -6.5	± 2	5 6.5	mV
TC V_{OS}	Input Offset Average Drift	$V_{CM} = 2.5V$ (Note 7)		6		$\mu V/^\circ C$
I_B	Input Bias Current	$V_{CM} = 2.5V$		6	12 18	μA
I_{OS}	Input Offset Current	$V_{CM} = 2.5V$	-2 -3	0.5	2 3	μA
R_{IN}	Input Resistance	Common Mode		4		$M\Omega$
		Differential Mode		20		$k\Omega$
C_{IN}	Input Capacitance	Common Mode		1.8		pF
		Differential Mode		1		
CMRR	Common Mode Rejection Ratio	Input Referred, $V_{CM} = 0V$ to $-2.5V$	70 68	90		dB
CMVR	Input Common Mode Voltage Range	CMRR ≥ 50 dB		-0.15	0	V
			3.5	3.7		
Transfer Characteristics						
A_{VOL}	Large Signal Voltage Gain	$V_O = 1.6 V_{PP}, R_L = 100\Omega$	58 55	64		dB
Output Characteristics						
V_O	Output Swing High	No Load	3.6 3.4	3.75		V
	Output Swing Low	No Load		0.9	1.1 1.3	
	Output Swing High	$R_L = 100\Omega$	3.5 3.35	3.70		
	Output Swing Low	$R_L = 100\Omega$		1	1.3 1.45	
I_{SC}	Short Circuit Current (Note 3)	Sourcing, $V_O = 2.5V$ $\Delta V_{IN} = 200$ mV	90 80	170		mA
		Sinking, $V_O = 2.5V$ $\Delta V_{IN} = 200$ mV	70 60	140		
I_{OUT}	Output Current	Sourcing, $V_O = +3.5V$		30		mA
		Sinking, $V_O = 1.5V$		60		
R_O	Output Resistance	$A_V = +1, f < 100$ kHz		.08		Ω
Power Supply						
PSRR	Power Supply Rejection Ratio	Input Referred, $V_S = \pm 2.5V$ to $\pm 3V$	60	75		dB
I_S	Supply Current (per channel)			4.5	6 7	mA

Note 1: Absolute Maximum Ratings indicate limits beyond which damage to the device may occur. Operating Ratings indicate conditions for which the device is intended to be functional, but specific performance is not guaranteed. For guaranteed specifications and the test conditions, see the Electrical Characteristics Table.

Note 2: Human body model, 1.5 k Ω in series with 100 pF. Machine model: 0 Ω in series with 100 pF.

Note 3: Continuous short circuit operation at elevated ambient temperature can result in exceeding the maximum allowed junction temperature at 150°C.

Note 4: The maximum power dissipation is a function of $T_{J(MAX)}$, θ_{JA} and T_A . The maximum allowable power dissipation at any ambient temperature is $P_D = (T_{J(MAX)} - T_A)/\theta_{JA}$. All numbers apply for packages soldered directly onto a PC board.

Note 5: Typical Values represent the most likely parametric norm.

Note 6: All limits are guaranteed by testing or statistical analysis.

Note 7: Offset voltage average drift is determined by dividing the change in V_{OS} at temperature extremes into the total temperature change.

Note 8: Slew rate is the slower of the rising and falling slew rates. Slew rate is rate of change from 10% to 90% of output voltage step.

Connection Diagrams

8-Pin SOIC (LMH6654)

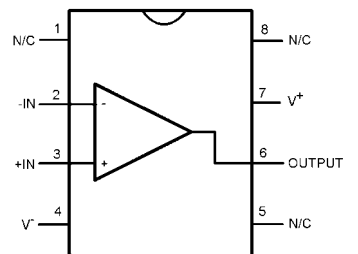

Top View

20016521

5-Pin SOT-23 (LMH6654)

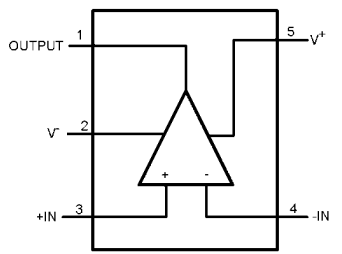

Top View

20016520

8-Pin SOIC and MSOP (LMH6655)

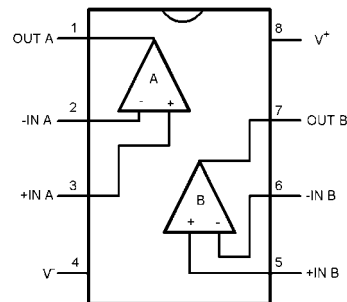

Top View

20016519

Ordering Information

Package	Part Number	Package Marking	Transport Media	NSC Drawing
8-Pin SOIC	LMH6654MA	LMH6654MA	95 Units Rails	M08A
	LMH6654MAX		2.5k Units Tape and Reel	
	LMH6655MA	LMH6655MA	95 Units Rails	
	LMH6655MAX		2.5k Units Tape and Reel	
5-Pin SOT-23	LMH6654MF	A66A	1k Units Tape and Reel	MF05A
	LMH6654MFX		3K Units Tape and Reel	
8-Pin MSOP	LMH6655MM	A67A	1k Units Tape and Reel	MUA08A
	LMH6655MMX		3.5k Units Tape and Reel	

Typical Performance Characteristics $T_J = 25^\circ\text{C}$, $V^+ = \pm 5\text{V}$, $V^- = -5$, $R_F = 25\Omega$ for gain = +1, $R_F = 402\Omega$ and for gain $\geq +2$, and $R_L = 100\Omega$, unless otherwise specified.

Closed Loop Bandwidth (G = +1)

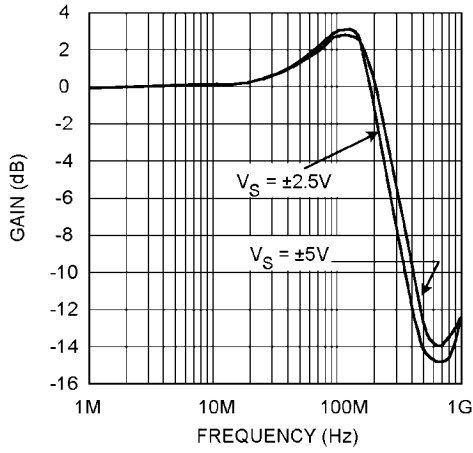

20016509

Closed Loop Bandwidth (G = +2)

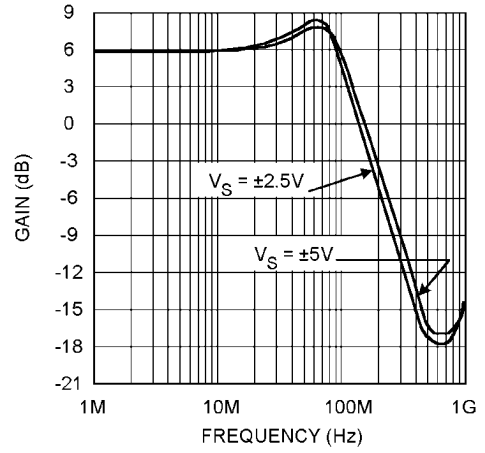

20016510

Closed Loop Bandwidth (G = +5)

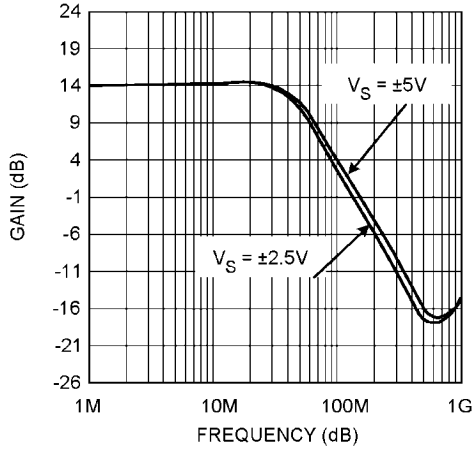

20016511

Closed Loop Bandwidth (G = +10)

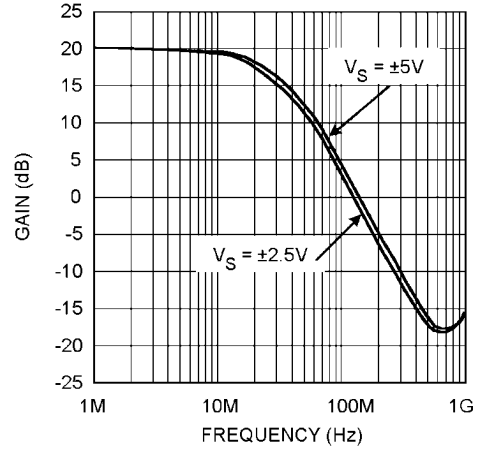

20016512

Supply Current per Channel vs. Supply Voltage

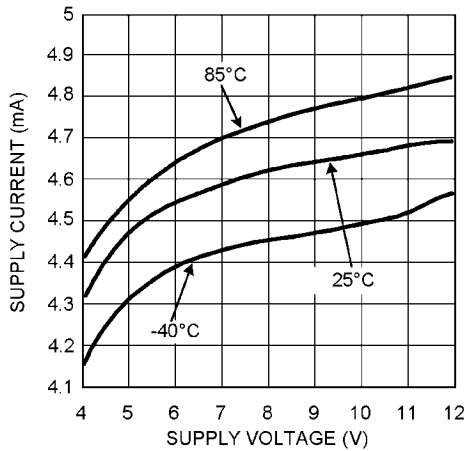

20016535

Supply Current per Channel vs. Temperature

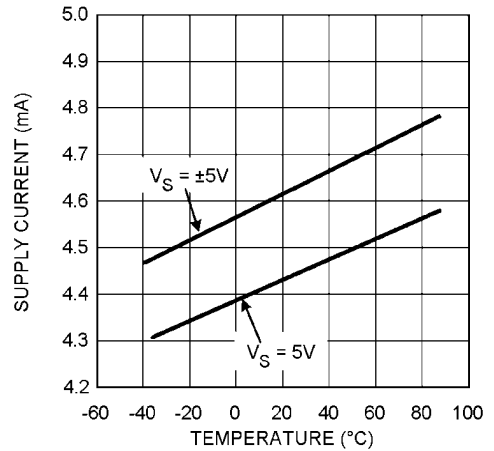

20016548

Offset Voltage vs. Supply Voltage ($V_{CM} = 0V$)

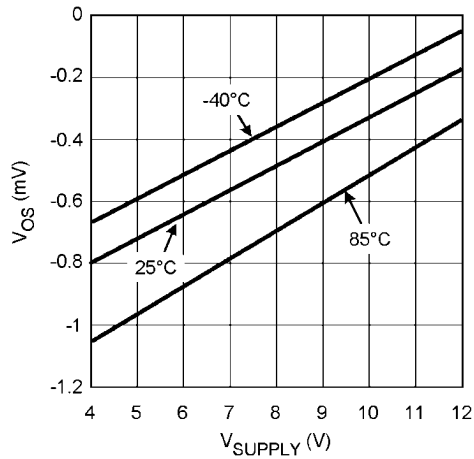

20016549

Offset Voltage vs. Common Mode

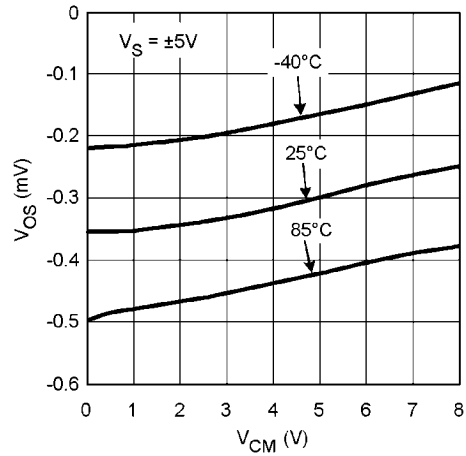

20016532

Offset Voltage vs. Common Mode

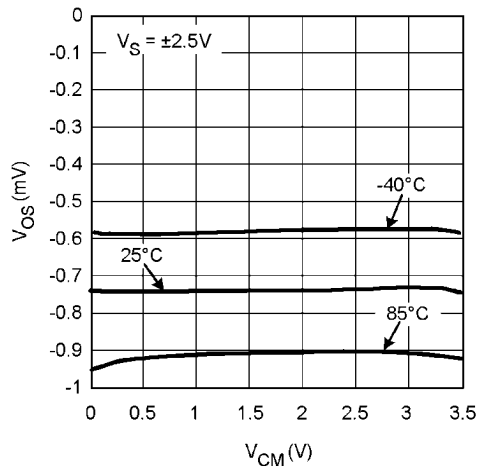

20016539

Bias Current and Offset Voltage vs. Temperature

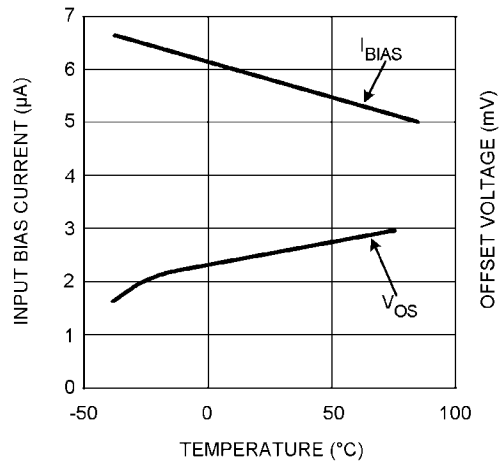

20016551

Bias Current vs. Common Mode Voltage

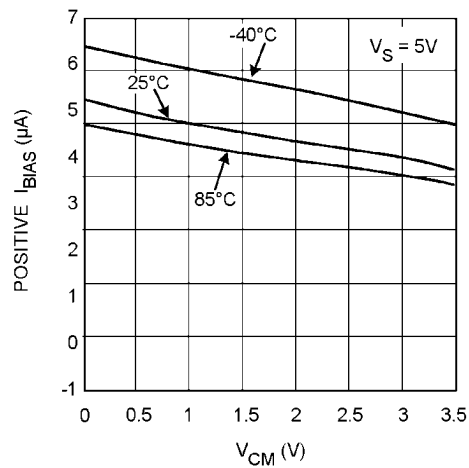

20016537

Bias Current vs. Common Mode Voltage

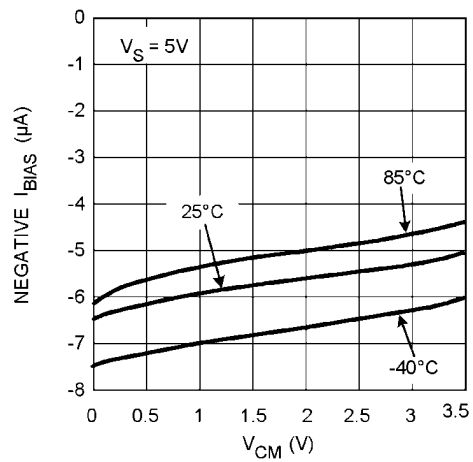

20016565

A_{OL}: PSRR and CMRR vs. Temperature

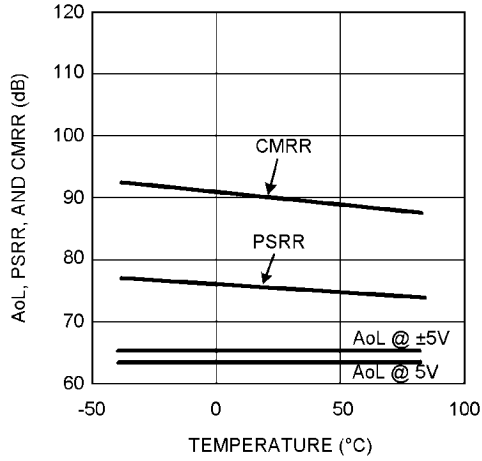

20016550

Inverting Large Signal Pulse Response ($V_S = 5V$)

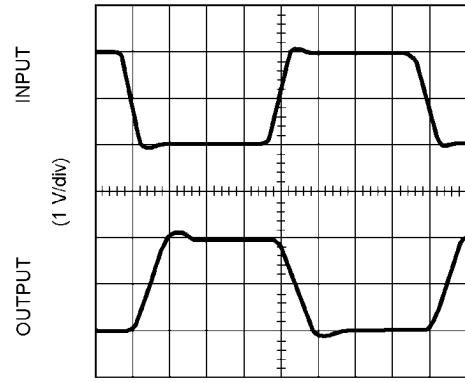

TIME (12.5 ns/div)

20016502

Inverting Large Signal Pulse Response ($V_S = \pm 5V$)

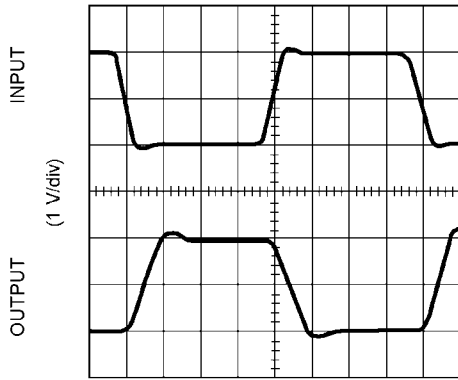

TIME (12.5 ns/div)

20016504

Non-Inverting Large Signal Pulse Response ($V_S = 5V$)

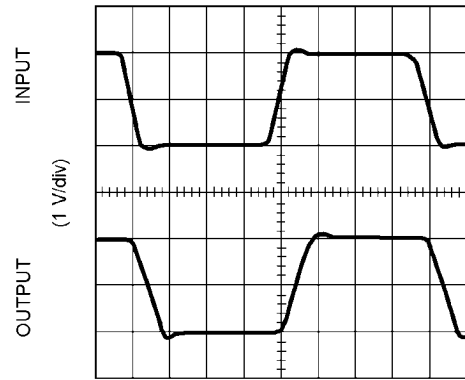

TIME (12.5 ns/div)

20016506

Non-Inverting Large Signal Pulse Response ($V_S = \pm 5V$)

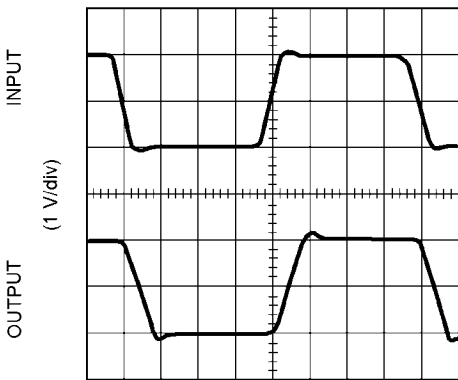

TIME (12.5 ns/div)

20016508

Non-Inverting Small Signal Pulse Response ($V_S = 5V$)

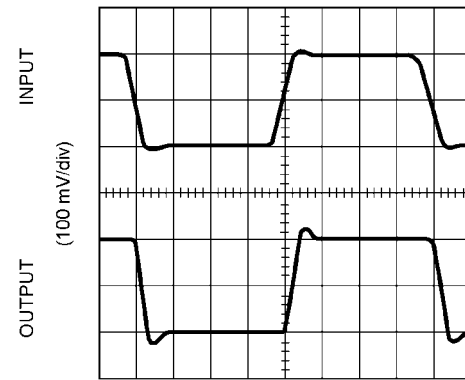

TIME (12.5 ns/div)

20016505

Non-Inverting Small Signal Pulse Response ($V_S = \pm 5V$)

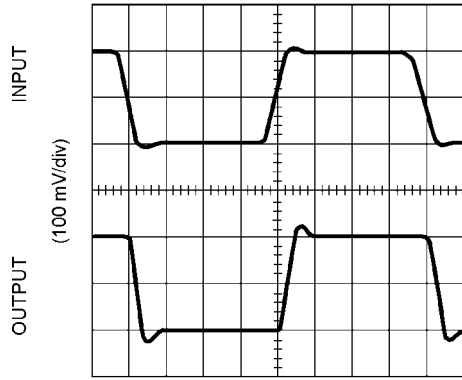

TIME (12.5 ns/div)

20016507

Inverting Small Signal Pulse Response ($V_S = 5V$)

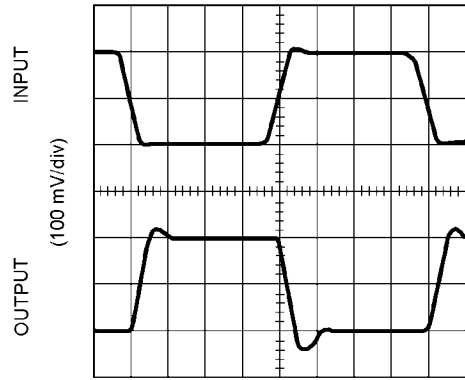

TIME (12.5 ns/div)

20016501

Inverting Small Signal Pulse Response ($V_S = \pm 5V$)

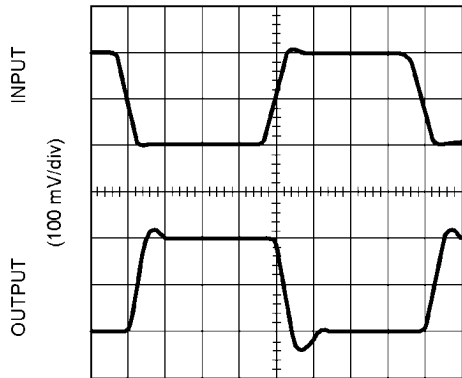

TIME (12.5 ns/div)

20016503

Input Voltage and Current Noise vs. Frequency ($V_S = 5V$)

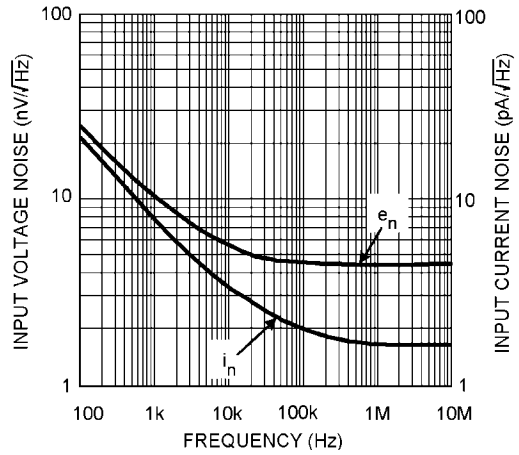

20016513

Input Voltage and Current Noise vs. Frequency ($V_S = \pm 5V$)

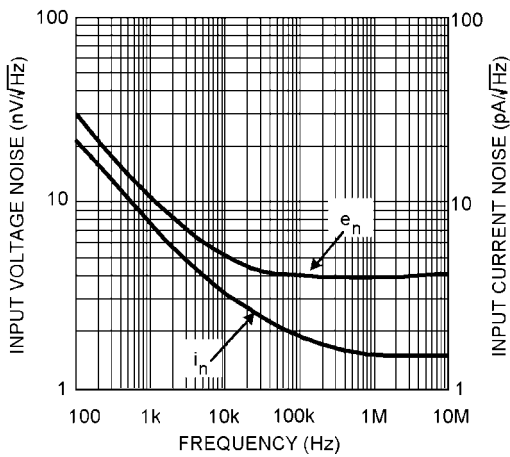

20016514

Harmonic Distortion vs. Frequency
 $G = +1, V_O = 2 V_{PP}, V_S = 5V$

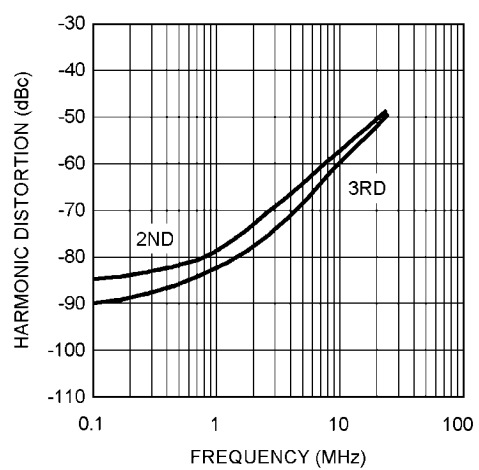

20016517

Harmonic Distortion vs. Frequency
 $G = +1, V_O = 2 V_{PP}, V_S = \pm 5V$

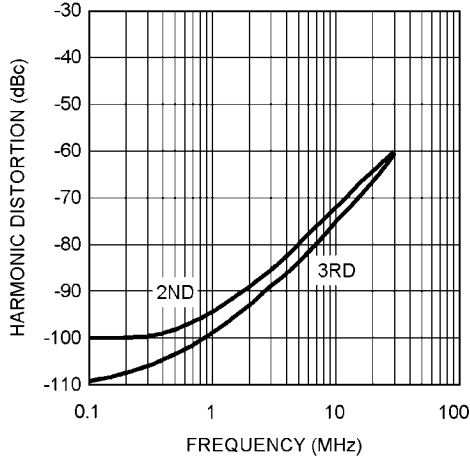

20016518

Harmonic Distortion vs. Temperature
 $V_S = 5V, f = 5 \text{ MHz}, V_O = 2 V_{PP}$

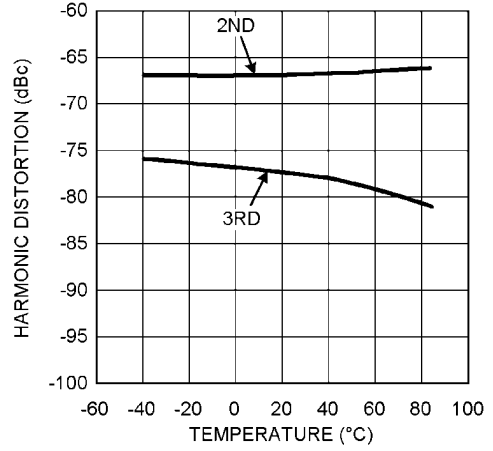

20016529

Harmonic Distortion vs. Temperature
 $V_S = \pm 5V, f = 5 \text{ MHz}, V_O = 2 V_{PP}$

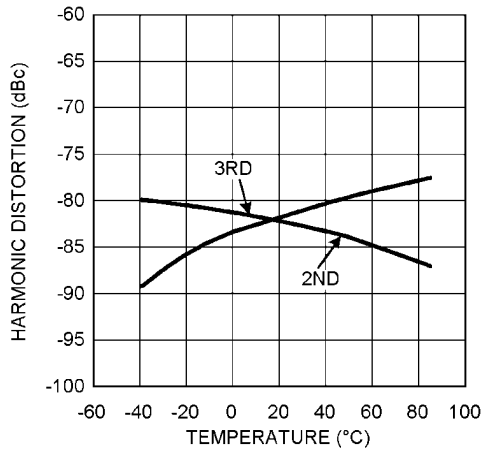

20016528

Harmonic Distortion vs. Gain
 $V_S = 5V, f = 5 \text{ MHz}, V_O = 2 V_{PP}$

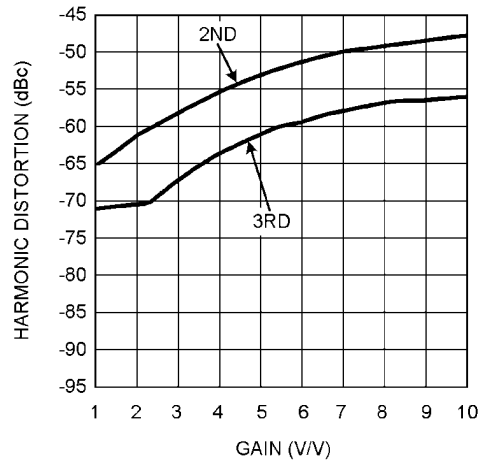

20016531

Harmonic Distortion vs. Gain
 $V_S = \pm 5V, f = 5 \text{ MHz}, V_O = 2 V_{PP}$

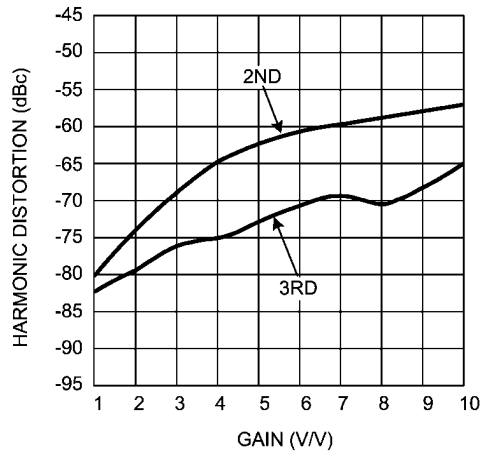

20016530

Harmonic Distortion vs. Output Swing
 $(G = +2, V_S = 5V, f = 5 \text{ MHz})$

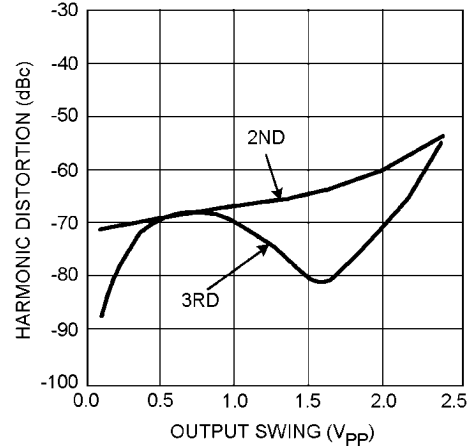

20016559

Harmonic Distortion vs. Output Swing
($G = +2$, $V_S = \pm 5V$, $f = 5\text{ MHz}$)

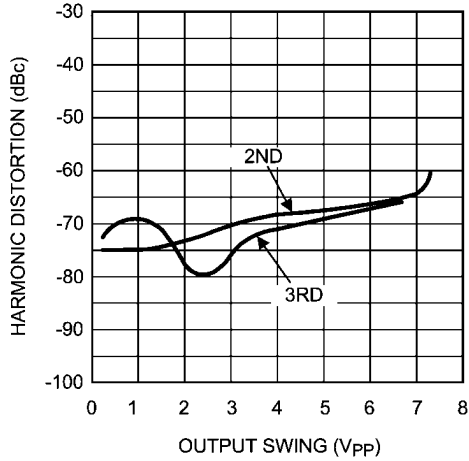

20016522

PSRR vs. Frequency

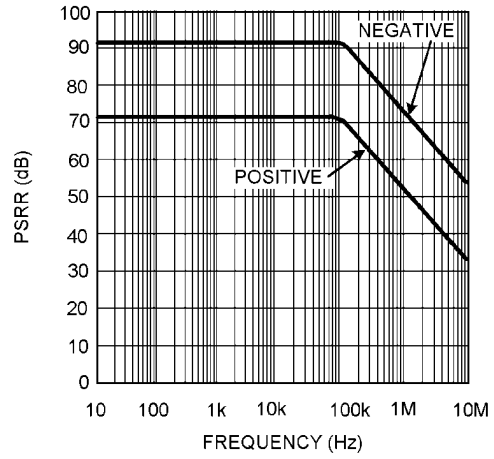

20016516

CMRR vs. Frequency

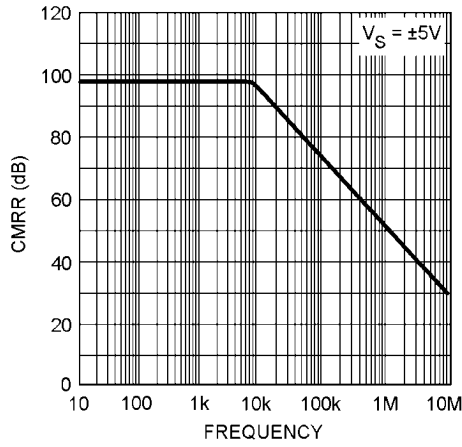

20016564

Output Sinking Current

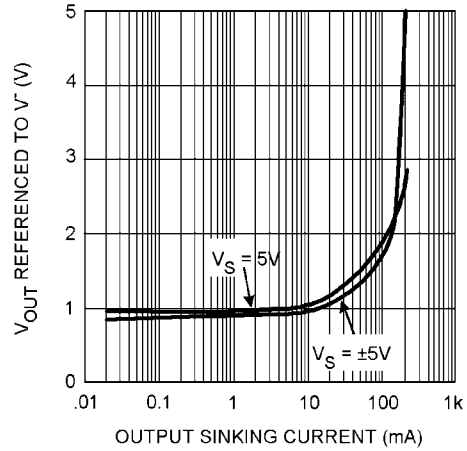

20016546

Output Sourcing Current

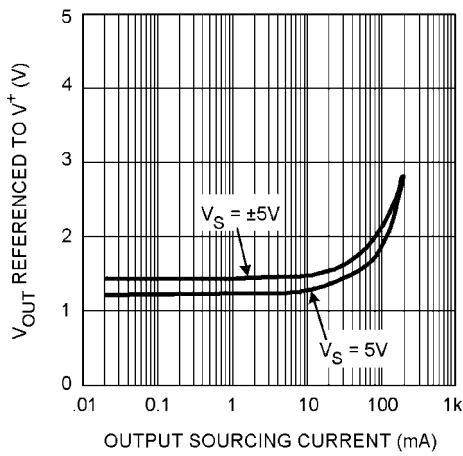

20016547

CrossTalk vs. Frequency (LMH6655 only)

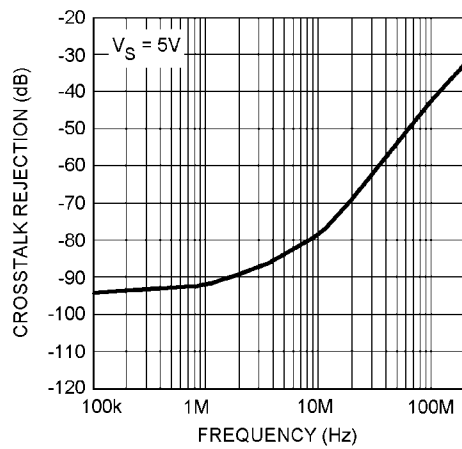

20016561

Crosstalk vs. Frequency (LMH6655 only)

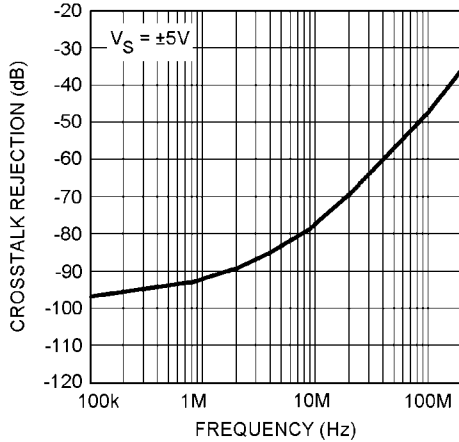

20016562

Isolation Resistance vs. Capacitive Load

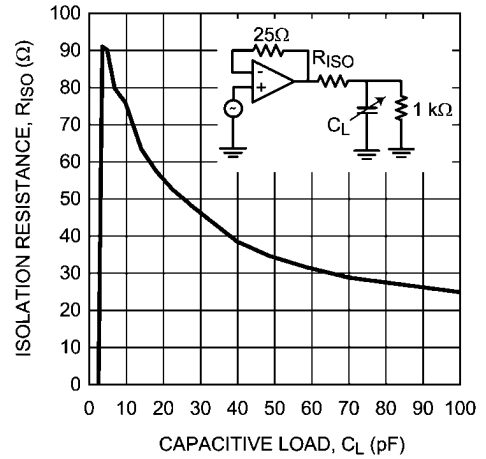

20016563

Open Loop Gain and Phase vs. Frequency

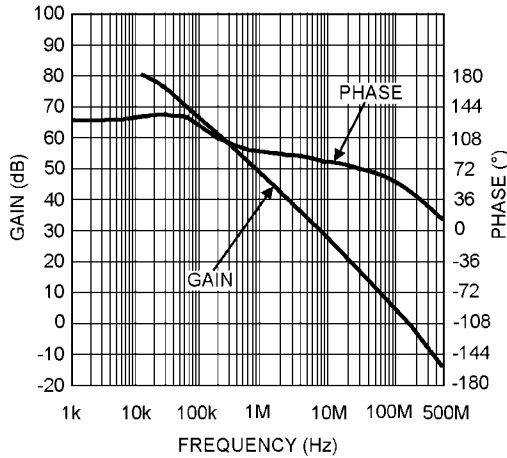

20016527

Application Information

GENERAL INFORMATION

The LMH6654 single and LMH6655 dual high speed, voltage feedback amplifiers are manufactured on National Semiconductor's new VIP10 (Vertically Integrated PNP) complementary bipolar process. These amplifiers can operate from $\pm 2.5V$ to $\pm 6V$ power supply. They offer low supply current, wide bandwidth, very low voltage noise and large output swing. Many of the typical performance plots found in the datasheet can be reproduced if 50Ω coax and 50Ω R_{IN}/R_{OUT} resistors are used.

CIRCUIT LAYOUT CONSIDERATION

With all high frequency devices, board layouts with stray capacitance have a strong influence on the AC performance. The LMH6654/LMH6655 are not exception and the inverting input and output pins are particularly sensitive to the coupling of parasitic capacitance to AC ground. Parasitic capacitances on the inverting input and output nodes to ground could cause frequency response peaking and possible circuit oscillation. Therefore, the power supply, ground traces and ground plan should be placed away from the inverting input and output pins. Also, it is very important to keep the parasitic capacitance across the feedback to an absolute minimum.

The PCB should have a ground plane covering all unused portion of the component side of the board to provide a low impedance path. All trace lengths should be minimized to reduce series inductance.

Supply bypassing is required for the amplifiers performance. The bypass capacitors provide a low impedance return current path at the supply pins. They also provide high frequency filtering on the power supply traces. It is recommended that a ceramic decoupling capacitor $0.1\ \mu F$ chip should be placed with one end connected to the ground plane and the other side as close as possible to the power pins. An additional $10\ \mu F$ tantalum electrolytic capacitor should be connected in parallel, to supply current for fast large signal changes at the output.

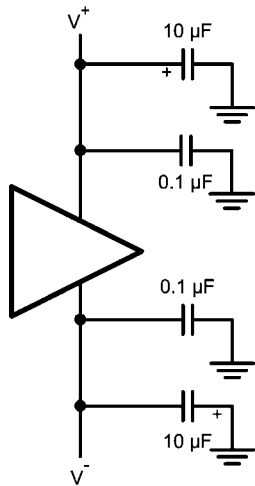

20016541

FIGURE 1.

EVALUATION BOARDS

National provides the following evaluation boards as a guide for high frequency layout and as an aid in device testing and characterization.

Device	Package	Evaluation Board PN
LMH6654MF	5-Pin SOT-23	CLC730068
LMH6654MA	8-Pin SOIC	CLC730027
LMH6655MA	8-Pin SOIC	CLC730036
LMH6655MM	8-Pin MSOP	CLC730123

The free evaluation board are shipped automatically when a device sample request is placed with National Semiconductor.

The CLC730027 datasheet also contains tables of recommended components to evaluate several of National’s high speed amplifiers. This table for the LMH6654 is illustrated below. Refer to the evaluation board datasheet for schematics and further information.

Components Needed to Evaluate the LMH6654 on the Evaluation Board:

- R_f, R_g use the datasheet to select values.
- R_{IN}, R_{OUT} typically 50Ω (Refer to the Basic Operation section of the evaluation board datasheet for details)
- R_f is an optional resistor for inverting again configurations (select R_f to yield desired input impedance = $R_g || R_f$)
- C_1, C_2 use $0.1 \mu F$ ceramic capacitors
- C_3, C_4 use $10 \mu F$ tantalum capacitors

Components not used:

1. C_5, C_6, C_7, C_8
2. R1 thru R8

The evaluation boards are designed to accommodate dual supplies. The board can be modified to provide single operation. For best performance;

- 1) do not connect the unused supply.
- 2) ground the unused supply pin.

POWER DISSIPATION

The package power dissipation should be taken into account when operating at high ambient temperature and/or high power dissipative conditions. In determining maximum operable

temperature of the device, make sure the total power dissipation of the device is considered; this power dissipated in the device with a load connected to the output as well as the nominal dissipation of the op amp.

DRIVING CAPACITIVE LOADS

Capacitive loads decrease the phase margin of all op amps. The output impedance of a feedback amplifier becomes inductive at high frequencies, creating a resonant circuit when the load is capacitive. This can lead to overshoot, ringing and oscillation. To eliminate oscillation or reduce ringing, an isolation resistor can be placed as shown in Figure 2 below. At frequencies above

$$F = \frac{1}{2 \pi R_{ISO} C_{LOAD}}$$

the load impedance of the Amplifier approaches R_{ISO} . The desired performance depends on the value of the isolation resistor. The isolation resistance vs. capacitance load graph in the typical performance characteristics provides the means for selection of the value of R_S that provides ≤ 3 dB peaking in closed loop $A_V = 1$ response. In general, the bigger the isolation resistor, the more damped the pulse response becomes. For initial evaluation, a 50Ω isolation resistor is recommended.

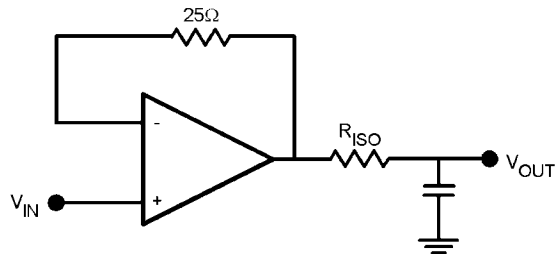

20016540

FIGURE 2.

COMPONENTS SELECTION AND FEEDBACK RESISTOR

It is important in high-speed applications to keep all component leads short since wires are inductive at high frequency. For discrete components, choose carbon composition axially leaded resistors and micro type capacitors. Surface mount components are preferred over discrete components for minimum inductive effect. Never use wire wound type resistors in high frequency applications.

Large values of feedback resistors can couple with parasitic capacitance and cause undesired effects such as ringing or oscillation in high-speed amplifiers. Keep resistors as low as possible consistent with output loading consideration. For a gain of 2 and higher, 402 Ω feedback resistor used for the typical performance plots gives optimal performance. For unity gain follower, a 25 Ω feedback resistor is recommended rather than a direct short. This effectively reduces the Q of what

would otherwise be a parasitic inductance (the feedback wire) into the parasitic capacitance at the inverting input.

BIAS CURRENT CANCELLATION

In order to cancel the bias current errors of the non-inverting configuration, the parallel combination of the gain setting R_g and feedback R_f resistors should equal the equivalent source resistance R_{seq} as defined in Figure 3. Combining this constraint with the non-inverting gain equation, allows both R_f and R_g to be determined explicitly from the following equations:

$$R_f = A_V R_{seq} \text{ and } R_g = R_f / (A_V - 1)$$

For inverting configuration, bias current cancellation is accomplished by placing a resistor R_b on the non-inverting input equal in value to the resistance seen by the inverting input ($R_f // (R_g + R_s)$). The additional noise contribution of R_b can be minimized through the use of a shunt capacitor.

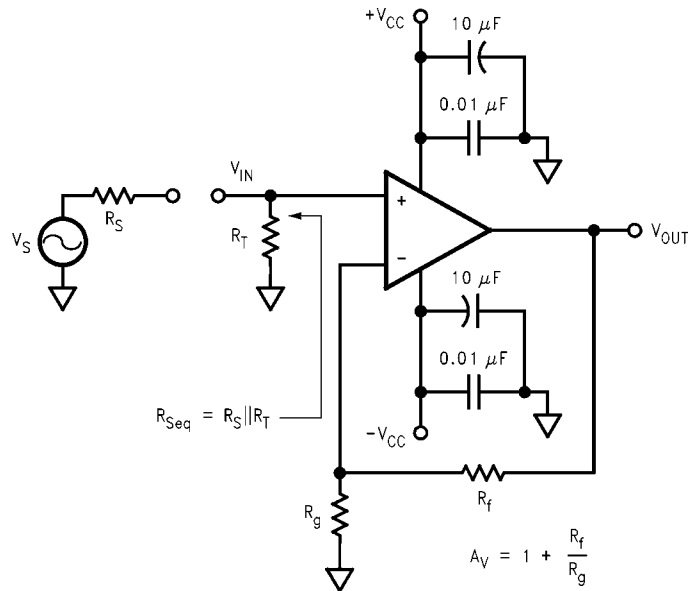

20016542

FIGURE 3. Non-Inverting Amplifier Configuration

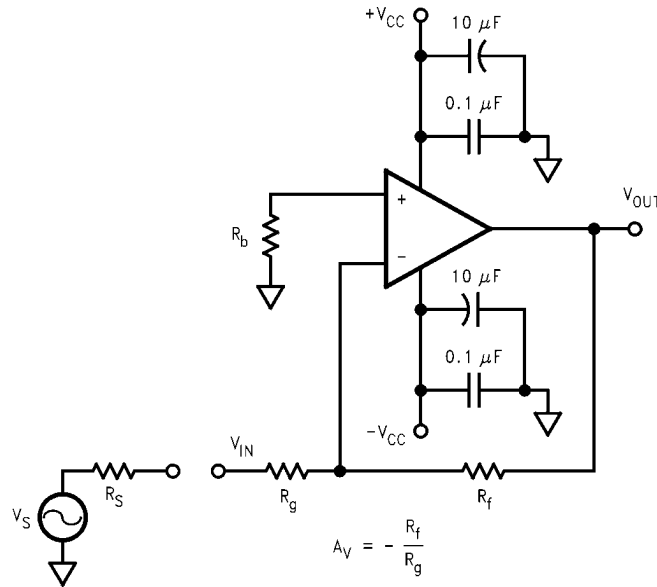

20016543

FIGURE 4. Inverting Amplifier Configuration

TOTAL INPUT NOISE VS. SOURCE RESISTANCE

The noise model for the non-inverting amplifier configuration showing all noise sources is described in Figure 5. In addition to the intrinsic input voltage noise (e_n) and current noise ($i_n = i_{n+} = i_{n-}$) sources, there also exists thermal voltage noise $e_i = \sqrt{4kTR}$ associated with each of the external resistors. Equation 1 provides the general form for total equivalent input voltage noise density (e_{ni}). Equation 2 is a simplification of Equation 1 that assumes

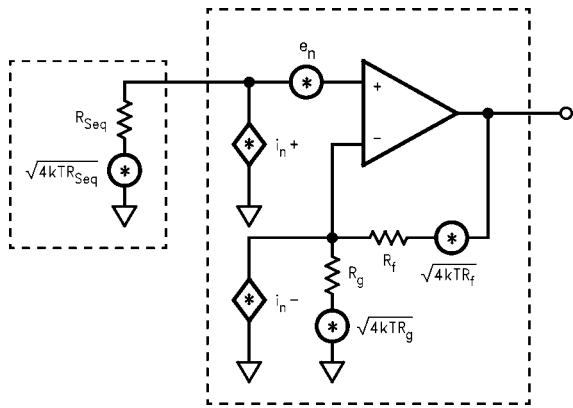

20016544

FIGURE 5. Non-Inverting Amplifier Noise Model

$$e_{ni} = \sqrt{e_n^2 + (i_n + R_{seq})^2 + 4kTR_{seq} + (i_n - (R_f \parallel R_g))^2 + 4kT(R_f \parallel R_g)} \quad (1)$$

Noise Figure

Noise Figure (NF) is a measure of the noise degradation caused by an amplifier.

$$NF = 10 \text{LOG} \left[\frac{S_f/N_f}{S_o/N_o} \right] = 10 \text{LOG} \left[\frac{e_{ni}^2}{e_t^2} \right] \quad (3)$$

$R_f \parallel R_g = R_{seq}$ for bias current cancellation. Figure 6 illustrates the equivalent noise model using this assumption. The total equivalent output voltage noise (e_{no}) is $e_{ni} * A_V$.

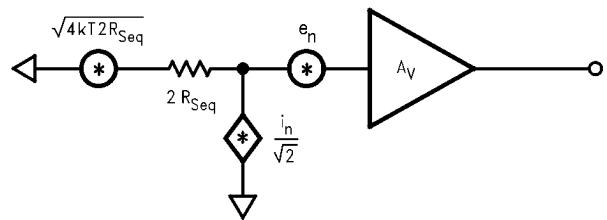

20016545

FIGURE 6. Noise Model with $R_f \parallel R_g = R_{seq}$

$$e_{ni} = \sqrt{e_n^2 + 2 (i_n R_{seq})^2 + 4kT (2R_{seq})} \quad (2)$$

If bias current cancellation is not a requirement, then $R_f \parallel R_g$ does not need to equal R_{seq} . In this case, according to Equation 1, $R_f R_g$ should be as low as possible in order to minimize noise. Results similar to Equation 1 are obtained for the inverting configuration on Figure 2 if R_{seq} is replaced by R_b and R_g is replaced by $R_g + R_s$. With these substitutions, Equation 1 will yield an e_{ni} referred to the non-inverting input. Referring to e_{ni} to the inverting input is easily accomplished by multiplying e_{ni} by the ratio of non-inverting to inverting gains.

The noise figure formula is shown as Equation 3. The addition of a terminating resistor R_T , reduces the external thermal noise but increases the resulting NF.

The NF is increased because the R_T reduces the input signal amplitude thus reducing the input SNR.

$$NF = 10 \text{ LOG} \left[\frac{e_n^2 + i_n^2 (R_{seq} + (R_f \parallel R_g)^2) + 4kTR_{seq} + 4kt (R_f \parallel R_g)}{4kTR_{seq}} \right] \quad (4)$$

The noise figure is related to the equivalent source resistance (R_{seq}) and the parallel combination of R_f and R_g . To minimize noise figure, the following steps are recommended:

1. Minimize $R_f \parallel R_g$
2. Choose the Optimum R_s (R_{OPT})

R_{OPT} is the point at which the NF curve reaches a minimum and is approximated by:

$$R_{OPT} \approx (e_n/i_n)$$

Physical Dimensions inches (millimeters) unless otherwise noted

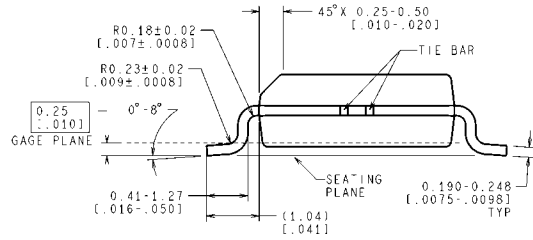
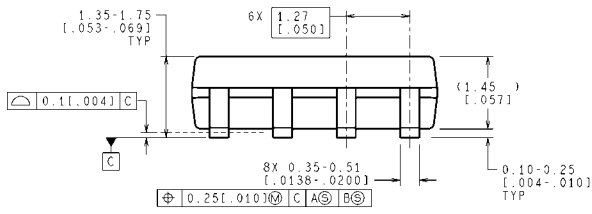
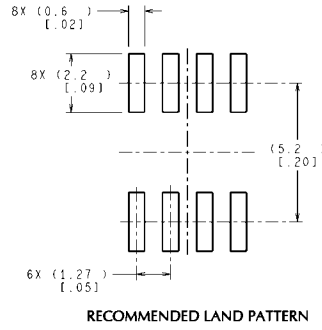
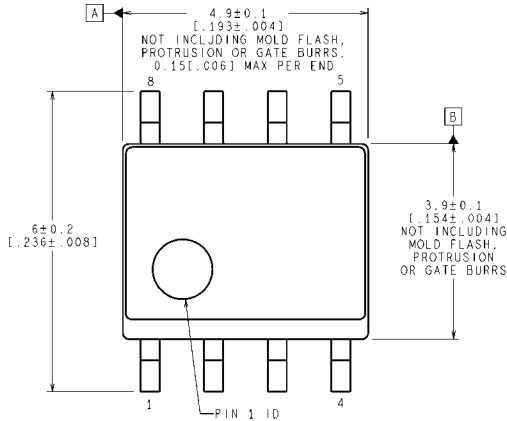

CONTROLLING DIMENSION IS MILLIMETER
VALUES IN [] ARE INCHES
DIMENSIONS IN () FOR REFERENCE ONLY

M08A (Rev M)

**8-Pin SOIC
NS Package Number M08A**

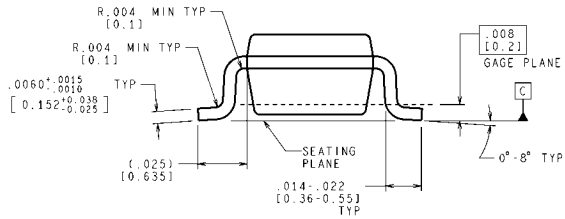
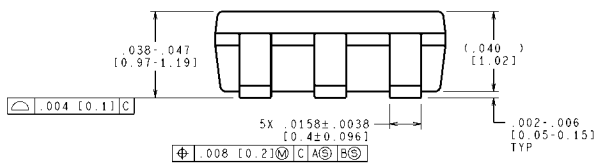
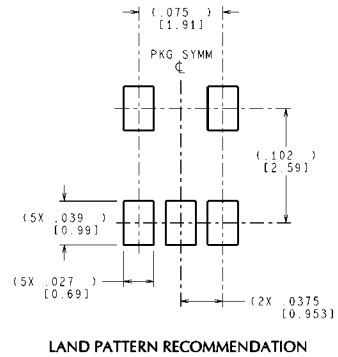
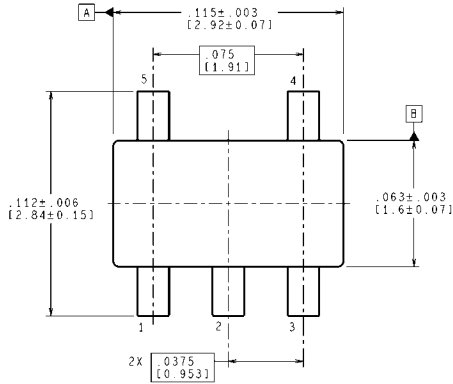

CONTROLLING DIMENSION IS INCH
VALUES IN [] ARE MILLIMETERS
DIMENSIONS IN () FOR REFERENCE ONLY

MF05A (Rev D)

**5-Pin SOT-23
NS Package Number MF05A**

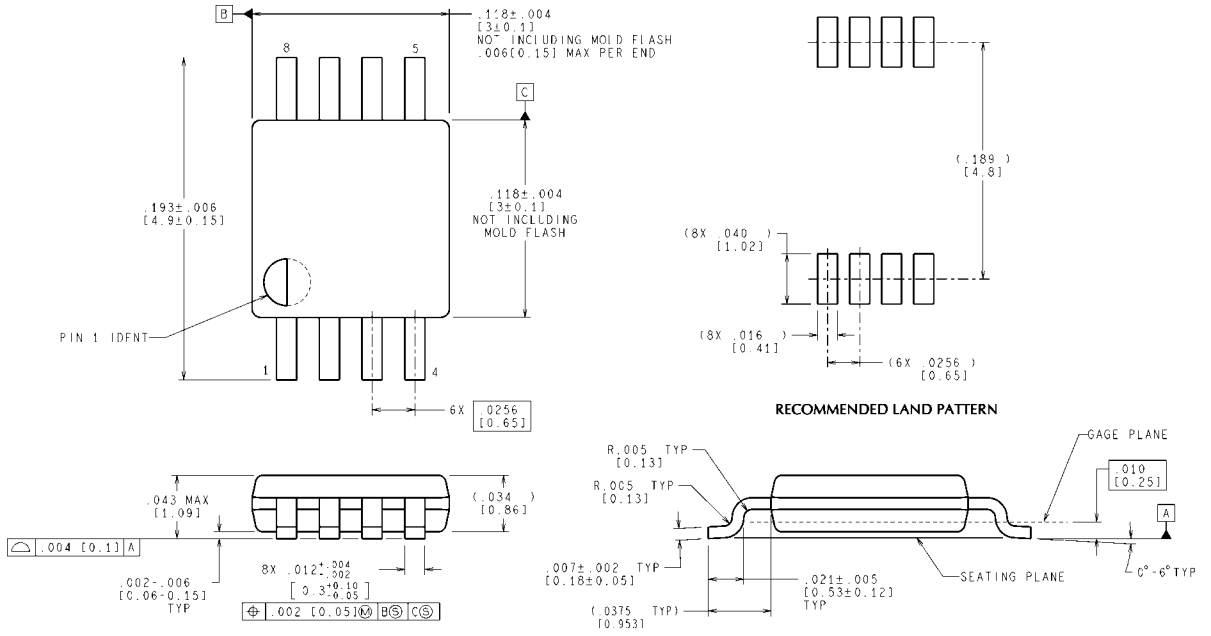

CONTROLLING DIMENSION IS INCH
 VALUES IN [] ARE MILLIMETERS

8-Pin MSOP
NS Package Number MUA08A

MUA08A (Rev F)

Notes

Notes

For more National Semiconductor product information and proven design tools, visit the following Web sites at:

Products		Design Support	
Amplifiers	www.national.com/amplifiers	WEBENCH® Tools	www.national.com/webench
Audio	www.national.com/audio	App Notes	www.national.com/appnotes
Clock and Timing	www.national.com/timing	Reference Designs	www.national.com/refdesigns
Data Converters	www.national.com/adc	Samples	www.national.com/samples
Interface	www.national.com/interface	Eval Boards	www.national.com/evalboards
LVDS	www.national.com/lvds	Packaging	www.national.com/packaging
Power Management	www.national.com/power	Green Compliance	www.national.com/quality/green
Switching Regulators	www.national.com/switchers	Distributors	www.national.com/contacts
LDOs	www.national.com/ldo	Quality and Reliability	www.national.com/quality
LED Lighting	www.national.com/led	Feedback/Support	www.national.com/feedback
Voltage Reference	www.national.com/vref	Design Made Easy	www.national.com/easy
PowerWise® Solutions	www.national.com/powerwise	Solutions	www.national.com/solutions
Serial Digital Interface (SDI)	www.national.com/sdi	Mil/Aero	www.national.com/milaero
Temperature Sensors	www.national.com/tempensors	SolarMagic™	www.national.com/solarmagic
Wireless (PLL/VCO)	www.national.com/wireless	PowerWise® Design University	www.national.com/training

THE CONTENTS OF THIS DOCUMENT ARE PROVIDED IN CONNECTION WITH NATIONAL SEMICONDUCTOR CORPORATION ("NATIONAL") PRODUCTS. NATIONAL MAKES NO REPRESENTATIONS OR WARRANTIES WITH RESPECT TO THE ACCURACY OR COMPLETENESS OF THE CONTENTS OF THIS PUBLICATION AND RESERVES THE RIGHT TO MAKE CHANGES TO SPECIFICATIONS AND PRODUCT DESCRIPTIONS AT ANY TIME WITHOUT NOTICE. NO LICENSE, WHETHER EXPRESS, IMPLIED, ARISING BY ESTOPPEL OR OTHERWISE, TO ANY INTELLECTUAL PROPERTY RIGHTS IS GRANTED BY THIS DOCUMENT.

TESTING AND OTHER QUALITY CONTROLS ARE USED TO THE EXTENT NATIONAL DEEMS NECESSARY TO SUPPORT NATIONAL'S PRODUCT WARRANTY. EXCEPT WHERE MANDATED BY GOVERNMENT REQUIREMENTS, TESTING OF ALL PARAMETERS OF EACH PRODUCT IS NOT NECESSARILY PERFORMED. NATIONAL ASSUMES NO LIABILITY FOR APPLICATIONS ASSISTANCE OR BUYER PRODUCT DESIGN. BUYERS ARE RESPONSIBLE FOR THEIR PRODUCTS AND APPLICATIONS USING NATIONAL COMPONENTS. PRIOR TO USING OR DISTRIBUTING ANY PRODUCTS THAT INCLUDE NATIONAL COMPONENTS, BUYERS SHOULD PROVIDE ADEQUATE DESIGN, TESTING AND OPERATING SAFEGUARDS.

EXCEPT AS PROVIDED IN NATIONAL'S TERMS AND CONDITIONS OF SALE FOR SUCH PRODUCTS, NATIONAL ASSUMES NO LIABILITY WHATSOEVER, AND NATIONAL DISCLAIMS ANY EXPRESS OR IMPLIED WARRANTY RELATING TO THE SALE AND/OR USE OF NATIONAL PRODUCTS INCLUDING LIABILITY OR WARRANTIES RELATING TO FITNESS FOR A PARTICULAR PURPOSE, MERCHANTABILITY, OR INFRINGEMENT OF ANY PATENT, COPYRIGHT OR OTHER INTELLECTUAL PROPERTY RIGHT.

LIFE SUPPORT POLICY

NATIONAL'S PRODUCTS ARE NOT AUTHORIZED FOR USE AS CRITICAL COMPONENTS IN LIFE SUPPORT DEVICES OR SYSTEMS WITHOUT THE EXPRESS PRIOR WRITTEN APPROVAL OF THE CHIEF EXECUTIVE OFFICER AND GENERAL COUNSEL OF NATIONAL SEMICONDUCTOR CORPORATION. As used herein:

Life support devices or systems are devices which (a) are intended for surgical implant into the body, or (b) support or sustain life and whose failure to perform when properly used in accordance with instructions for use provided in the labeling can be reasonably expected to result in a significant injury to the user. A critical component is any component in a life support device or system whose failure to perform can be reasonably expected to cause the failure of the life support device or system or to affect its safety or effectiveness.

National Semiconductor and the National Semiconductor logo are registered trademarks of National Semiconductor Corporation. All other brand or product names may be trademarks or registered trademarks of their respective holders.

Copyright© 2009 National Semiconductor Corporation

For the most current product information visit us at www.national.com



National Semiconductor Americas Technical Support Center
 Email: support@nsc.com
 Tel: 1-800-272-9959

National Semiconductor Europe Technical Support Center
 Email: europe.support@nsc.com

National Semiconductor Asia Pacific Technical Support Center
 Email: ap.support@nsc.com

National Semiconductor Japan Technical Support Center
 Email: jpn.feedback@nsc.com