

THIS DOCUMENT IS THE PROPERTY OF
KEYSTONE ELECTRONICS CORP. AND
SHALL NOT BE REPRODUCED, DISTRIBUTED
OR USED AS A BASIS FOR MANUFACTURE
WITHOUT PRIOR WRITTEN PERMISSION
FROM KEYSTONE ELECTRONICS CORP.

ACTUAL SIZE

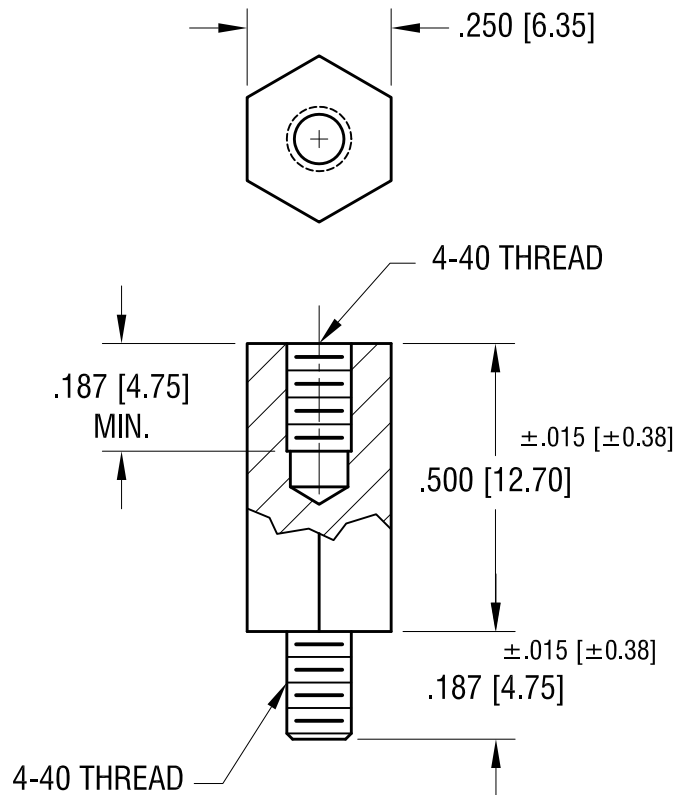
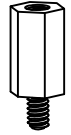

NOTE:

1. MAT'L- HIGH TEMPERATURE ,
HIGH PERFORMANCE NYLON (COLOR- BLACK)
2. TEMPERATURE RANGE: -20°F [-29°C] to +365°F [+185°C]

1.13.22	TEMP. WAS -20°F to +400°F CHANGE AS PER ECN 22-020	B
6.15.20	GENERAL TOLERANCE WAS ±.005 CHANGE AS PER ECN 20-053	A
DATE	DESCRIPTION	REV.

KEYSTONE ELECTRONICS CORP.			
www.keyelco.com • NEW HYDE PARK, NY 11040 • Tel (516) 328-7500			
PART NAME HIGH TEMPERATURE NYLON STANDOFF			
MATERIAL AS NOTED			
FINISH NONE		DRN BY NT	DATE 11.30.17
		APP'D LN	SCALE 3X
TOLERANCES	INCH [MM]	CODE	DWG NO.
DECIMAL	±.010 [±0.25]	C	4942
ANGULAR	± 1°		
UNLESS OTHERWISE SPECIFIED			