



Economy Power 2.5

TE Internal #: 2232905-1

Connector Contact, Socket, Wire-to-Board, 26 – 22 AWG Wire Size, .13 – .36 mm<sup>2</sup> Wire Size, Tin, Reel, Wire & Cable, 4.5 A, Signal, Economy Power 2.5

[View on TE.com >](#)

Connectors > PCB Connectors > Wire-to-Board Connectors > Wire-to-Board Connector Contacts



Contact Type: **Socket**

Connector System: **Wire-to-Board**

Centerline (Pitch): **2.5 mm [ .098 in ]**

Wire Size: **.13 – .36 mm<sup>2</sup>**

**Features**

**Product Type Features**

Applied Pressure	Low
Connector System	Wire-to-Board
Connector & Contact Terminates To	Wire & Cable

**Electrical Characteristics**

Operating Voltage	250 VAC
-------------------	---------

**Contact Features**

Mating Square Post Dimension	.6 mm[.023 in]
Contact Retention Within Housing	With
Wire Contact Termination Area Plating Thickness	.4 – 3.5 μm
Wire Contact Termination Area Plating Material Finish	Matte
Wire Contact Termination Area Plating Material	Pre-Tin
Contact Mating Area Plating Material Thickness	.4 – 3.5 μm[15.74 – 137.79 μin]
Contact Mating Area Plating Material Finish	Matte
Contact Length	1.8 mm[.071 in]
Contact Base Material	Phosphor Bronze

Contact Type	Socket
Contact Mating Area Plating Material	Tin
Contact Current Rating (Max)	4.5 A

#### Termination Features

Termination Method to Wire & Cable	Crimp
------------------------------------	-------

#### Mechanical Attachment

Contact Retention Type Within Housing	Locking Lance
Wire Insulation Support	With
Connector Mounting Type	Cable Mount (Free-Hanging)

#### Housing Features

Centerline (Pitch)	2.5 mm[.098 in]
--------------------	-----------------

#### Dimensions

Compatible Insulation Diameter Range	1.3 – 1.91 mm[.051 – .075 in]
Wire Size	.13 – .36 mm <sup>2</sup>

#### Usage Conditions

Operating Temperature Range	-55 – 105 °C[-67 – 221 °F]
-----------------------------	----------------------------

#### Operation/Application

Circuit Application	Signal
---------------------	--------

#### Packaging Features

Packaging Quantity	8000
Packaging Method	Reel

#### Product Compliance

[For compliance documentation, visit the product page on TE.com>](#)

EU RoHS Directive 2011/65/EU	Compliant
EU ELV Directive 2000/53/EC	Compliant
China RoHS 2 Directive MIIT Order No 32, 2016	No Restricted Materials Above Threshold
EU REACH Regulation (EC) No. 1907/2006	Current ECHA Candidate List: JUNE 2023 (235) Candidate List Declared Against: JAN 2023 (233) Does not contain REACH SVHC
Halogen Content	Low Halogen - Br, Cl, F, I < 900 ppm per

homogenous material. Also BFR/CFR/PVC Free

Solder Process Capability

Not reviewed for solder process capability

Product Compliance Disclaimer

This information is provided based on reasonable inquiry of our suppliers and represents our current actual knowledge based on the information they provided. This information is subject to change. The part numbers that TE has identified as EU RoHS compliant have a maximum concentration of 0.1% by weight in homogenous materials for lead, hexavalent chromium, mercury, PBB, PBDE, DBP, BBP, DEHP, DIBP, and 0.01% for cadmium, or qualify for an exemption to these limits as defined in the Annexes of Directive 2011/65/EU (RoHS2). Finished electrical and electronic equipment products will be CE marked as required by Directive 2011/65/EU. Components may not be CE marked. Additionally, the part numbers that TE has identified as EU ELV compliant have a maximum concentration of 0.1% by weight in homogenous materials for lead, hexavalent chromium, and mercury, and 0.01% for cadmium, or qualify for an exemption to these limits as defined in the Annexes of Directive 2000/53/EC (ELV). Regarding the REACH Regulation, the information TE provides on SVHC in articles for this part number is based on the latest European Chemicals Agency (ECHA) 'Guidance on requirements for substances in articles' posted at this URL: <https://echa.europa.eu/guidance-documents/guidance-on-reach>

## Compatible Parts



TE Part # 1969443-6  
EP 2.5 TPA Retainer, 6 Pos



TE Part # 2305570-1  
Strip Terminal Cutter-Side Feed-No Crimp



TE Part # CAT-G7534A-H342  
STD Temp Sig GRACE INERTIA Header



TE Part # 1969442-8  
EP 2.5 TPA Housing, 8 Pos



TE Part # 1-1969442-2  
EP 2.5 TPA Housing, 12 Pos



TE Part # 1-1744426-0  
Header Housing Assy, EP 2.5 RA, 10 Pos.



TE Part # 1-2299683-4  
EP2.5 HDR 4P VERT W/O BOSS, TAPING,RED



TE Part # 1-1969443-0  
EP 2.5 TPA Retainer, 10 Pos



TE Part # 1744426-2  
Header Housing Assy, EP 2.5 RA, 2 Pos.



TE Part # 1744418-4  
4 POS EP 2.5 HDR, GLOW WIRE



TE Part # 1-1969443-2  
EP 2.5 TPA Retainer, 12 Pos



TE Part # 1-2132230-3  
EP2.5 Shrouded HDR ASSY 13P VE



TE Part # 1744439-2  
EP2.5 Shrd HDR ASSY 2P VERT, GW



TE Part # 2-1744417-0  
20 POS EP 2.5 HSG, GLOW WIRE



TE Part # 2299683-2  
EP2.5 HDR ASSY 2P VERT W/O BOSS, TAPING



TE Part # 2299683-5  
EP2.5 HDR 5P VERT W/O BOSS, TAPING



TE Part # 1-1744439-8  
EP2.5 Shrd HDR ASSY 18P VERT, GW



TE Part # 1-1744446-3  
Hdr Assy, EP 2.5 RA, 13 Pos., GW



TE Part # 1-2299683-1  
EP2.5 HDR 2P VERT W/O BOSS, TAPING, RED



TE Part # 1-2299683-2  
EP2.5 HDR 2P VERT W/O BOSS, TAPING, RED

## Also in the Series | Economy Power 2.5

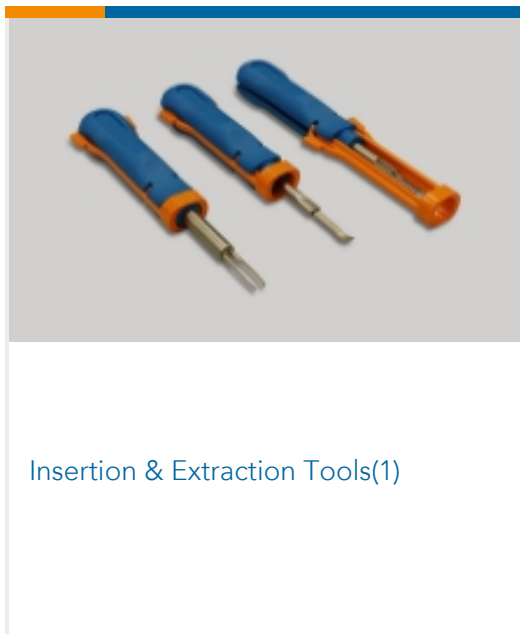

Insertion & Extraction Tools(1)



PCB Headers & Receptacles(494)



PCB Latches, Locks & Retainers(49)

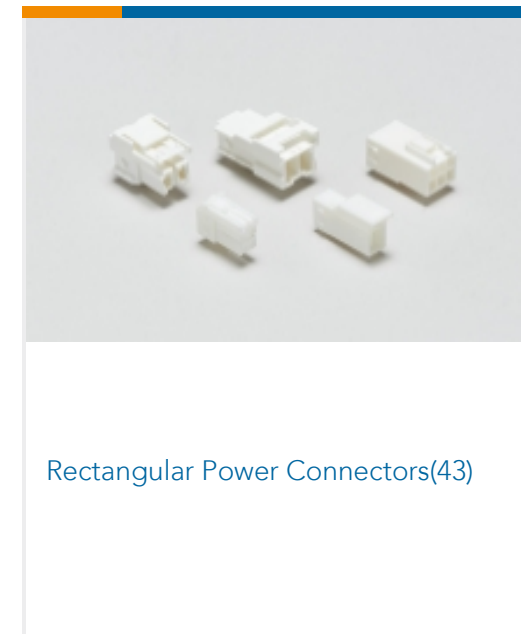

Rectangular Power Connectors(43)

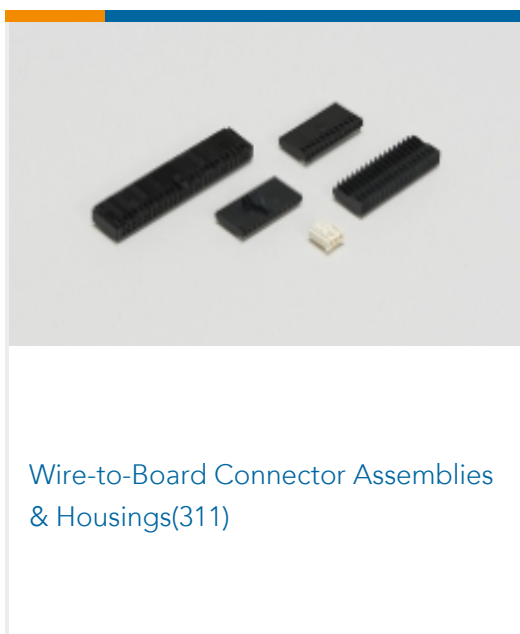

Wire-to-Board Connector Assemblies & Housings(311)

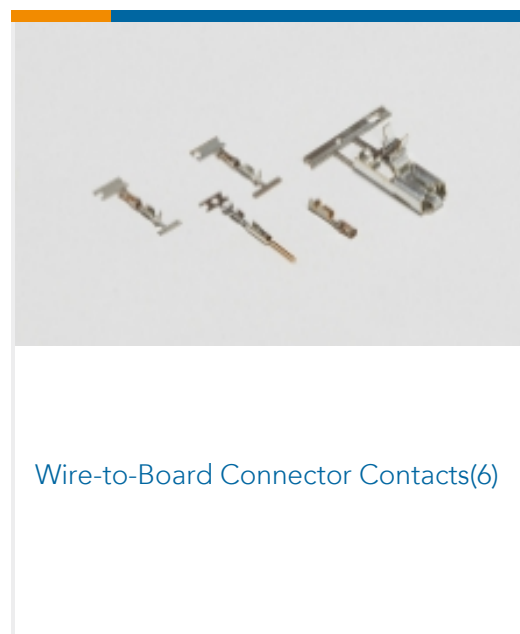

Wire-to-Board Connector Contacts(6)

## Customers Also Bought



TE Part #1565084-1  
GRACE INERTIA CONNECTOR 3.5 6P



TE Part #1746973-1  
GRACE INERTIA CONNECTOR 6.2 MM PITCH TAB

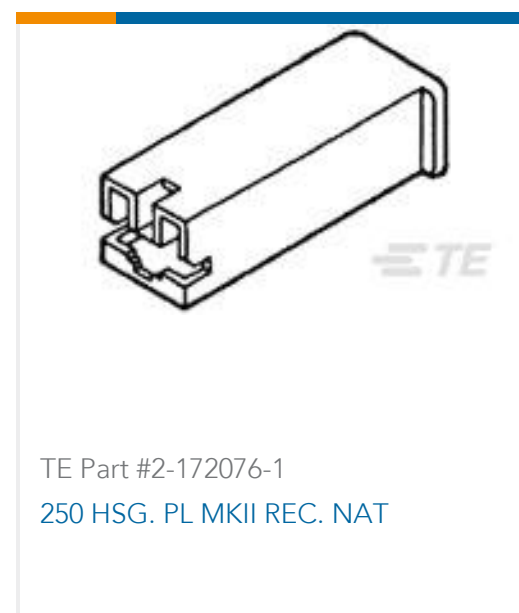

TE Part #2-172076-1  
250 HSG. PL MKII REC. NAT



TE Part #917707-1  
2.5 SIGNAL D.LOCK D.L.P 11P



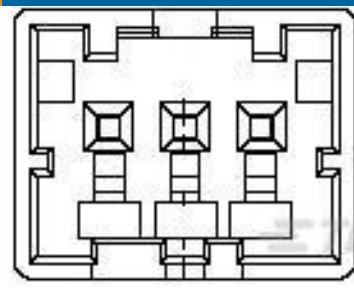

TE Part #1903392-1  
GIC 2.5 W CAP HSG 3P NATURAL



TE Part #1-1969541-2  
RETAINER, TPA, DUAL ROW, EP2.5

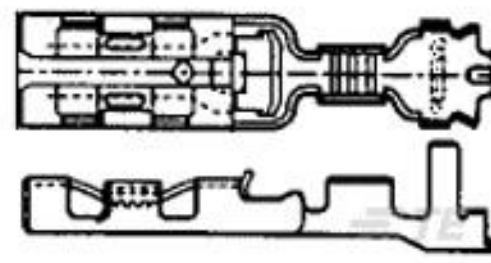

TE Part #353249-2  
110 PL EX REC. 26-22AWG PTPHBZ



TE Part #1-2323743-2  
HOUSING, PLUG, GWT, 12P, DUAL ROW, EP2.5



TE Part #2-1969541-6  
RETAINER, TPA, DUAL ROW, EP2.5



TE Part #2-2323743-6  
HOUSING, PLUG, GWT, 26P, DUAL ROW, EP2.5

## Documents

### Product Drawings

[EP 2.5 LIF RCPT CONTACT, 26-22 AWG](#)

English

### CAD Files

[3D PDF](#)

3D

Customer View Model

[ENG\\_CVM\\_CVM\\_2232905-1\\_A.2d\\_dxf.zip](#)

English

Customer View Model

[ENG\\_CVM\\_CVM\\_2232905-1\\_A.3d\\_igs.zip](#)

English

Customer View Model

[ENG\\_CVM\\_CVM\\_2232905-1\\_A.3d\\_stp.zip](#)

English

By downloading the CAD file I accept and agree to the [Terms and Conditions](#) of use.

### Datasheets & Catalog Pages

[7-1773461-6\\_EP2.5\\_Connector\\_Series](#)

English

### Product Specifications

[Application Specification](#)

English

### Product Environmental Compliance

[MD\\_2232905-1\\_09062018102\\_dmtec](#)

2232905-1

Connector Contact, Socket, Wire-to-Board, 26 – 22 AWG Wire Size, .13 – .36 mm<sup>2</sup>  
Wire Size, Tin, Reel, Wire & Cable, 4.5 A, Signal, Economy Power 2.5



English

[MD\\_2232905-1\\_09062018102\\_dmtec](#)

English