

KHS

KHAU

KHA series

General Purpose Dry Circuit to 5A Multicontact AC or DC Relay

File E22575

File LR15734

Features

- Miniature size from 2 pole to 4 pole.
- KHAU is produced on an automated line, while KHU is produced manually. Form, fit and function of the two versions are identical.
- KHS hermetically sealed version UL Approved for Class 1 Division 2 hazardous locations.
- Various applications include process control, photocopier, and data processing.
- Push-to-test and indicator options available.
- Various contact materials available for specific load requirements.

Contact Data @25°C

Arrangements: 2 Form C (DPDT), 4 Form C (4PDT).

Expected Life: 10 million operations, mechanical; 100,000 operations min. at rated loads. Ratings are based on tests of relays with ungrounded frames.

Initial Breakdown Voltage: 500V rms, 60 Hz., between open contacts.
1240V rms, 60 Hz., between all other elements.

Contact Ratings

Contact Code	Material	Resistive Rating	
		Minimum	Maximum
1	Silver	100mA @ 12VAC/12VDC	3A @ 120VAC/28VDC
2*	Silver-cadmium oxide	500mA @ 12VAC/12VDC	5A @ 120VAC/28VDC
3	Gold-silver-nickel	10mA @ 12VAC/12VDC	2A @ 120VAC/28VDC
6	Bifurcated cross bar, gold overlay silver	Dry circuit	1A @ 120VAC/28VDC
8	Gold diffused silver	50mA @ 12VAC/12VDC	3A @ 120VAC/28VDC

Note: Relays should only carry a maximum of 15 amps continuously for all poles combined.

KHS Contact Ratings

Class I Division II Hazardous Location:

5A@28VDC/120VAC

UL 508 (Industrial Control):

3A@28VDC/120VAC; 1/10 HP @ 120VAC.

Coil Data @25°C

Voltage: From 6 to 120VDC, and 6 to 240VAC, 50/60 Hz.

Nom. Power: DC coils - 0.9 watt; 0.5 watt minimum operate @25°C.

AC coils - 1.2 VA; 0.55 VA minimum operate @25°C.

Max. Power: DC coils - 2.0 watts @25°C.

Duty Cycle: Continuous.

Initial Breakdown Voltage: 500V rms, 60 Hz.

Coil Data

Nominal Voltage	DC Coils		AC Coils	
	Resistance in Ohms ±10% @ 25°C	Nominal Inductance in Henrys	Resistance in Ohms ±15%	Nominal AC Current in mA
5	32	.072	—	—
6	40	.08	10.5	200
12	160	.28	43	100
24	650	1.0	160	52
48	2,600	4.5	668	25
110 *	11,000	17.0	—	—
120 *	—	—	3,900	11.0
240	—	—	12,000	6.0

* Note: For 220 and 240VDC, use series dropping 5W resistor of 11,000Ω.

Operate Data @25°C

Must-Operate Voltage: DC: 75% of nominal voltage.

AC: 85% of nominal voltage.

Operate Time: 13 milliseconds typical @ nominal voltage (excluding bounce).

Release Time: 6 milliseconds typical @ nominal voltage (excluding bounce).

Environmental Data

Temperature Range: -45°C to +70°C operate.

-60°C to +130°C storage.

Mechanical Data

Mountings: #3-48 stud, sockets with printed circuit or solder terminals, or bracket plate with #6-32 threaded stud.

Termination: Printed circuit or solder/socket terminals.

Printed circuit terminals are available for KHS on a special order basis.

Enclosures: See Ordering Information table.

Weight: 1.6 oz. approx. (45g).

Outline Dimensions

Mounting Code 1 - KHAU only.

2 & 4 Pole

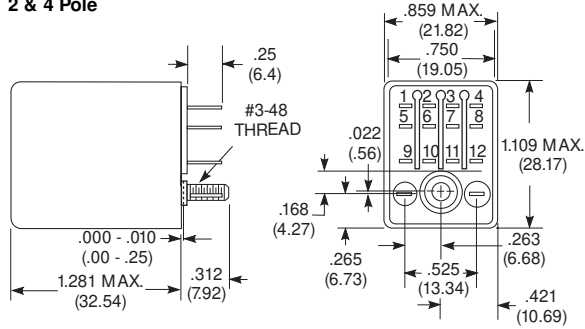

PC terminal models have rivet, not stud.
Max. seated height in 27E006 socket is 1.37" (34.8mm).

Mounting Code 1 - KHS only.

2 & 4 Pole

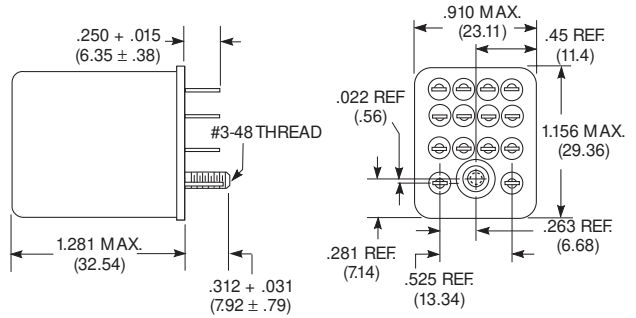

Class 1 Div. 2 Group A, B, C & D Hazards

Mounting Code 1 - Neon Indicator, Push-To-Test.

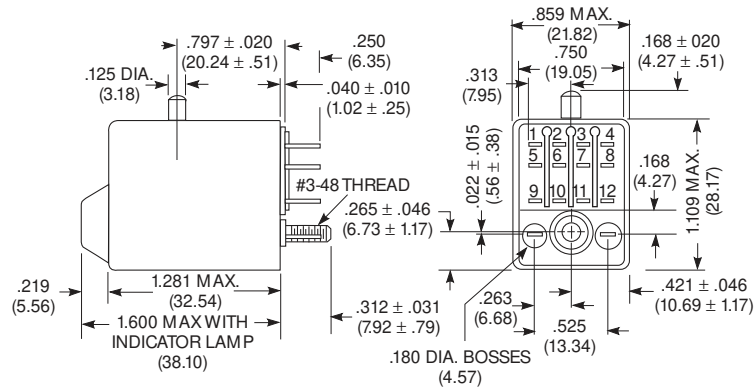

Printed Circuit Terminals

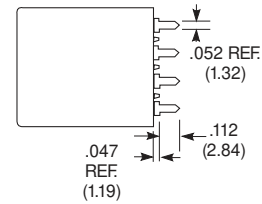

Printed circuit terminal thickness .022 (.558)

Wiring Diagrams (Bottom Views)

2 Pole

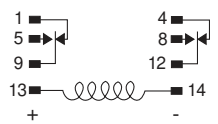

+ = Polarity for LED indicator.

4 Pole

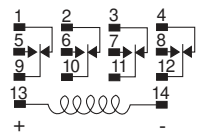

PC Board Layout (Bottom View)

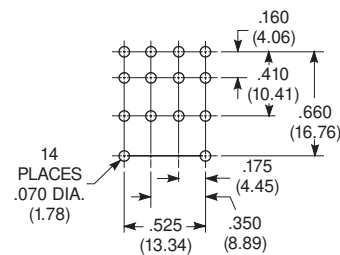

For KHAE Relays with PC terminals and sockets with PC terminals

Sockets For KHA And KHS Series

All sockets are normally maintained in stock for immediate delivery.

For KHAU, KHAX, KHS Relays.

Relays with solder terminals are required for use with sockets.

Socket Description

Industrial Part No.	No. of Poles	Terminal and Length	Grounding Provision	Socket Material
27E006*	4	Solder .375" (9.53mm)	Yes	Nylon
27E007*	4	P.C. .218" (5.54mm)	Yes	Nylon
27E023*	4	P.C. .218" (5.54mm)	No	Nylon
27E220*	2	P.C. .218" (5.54mm)	No	Nylon
27E166**	4	Screw	Yes	Glass-filled Polyester
27E894**	4	Screw	No	Glass-filled Polyester
20C217 20C297		Relay Hold Down Spring Relay Hold Down Spring (use with 27E166 & 27E894)		

* UL Recognized, file E22575

** UL Recognized, file E59244

Pierced Solder Terminals

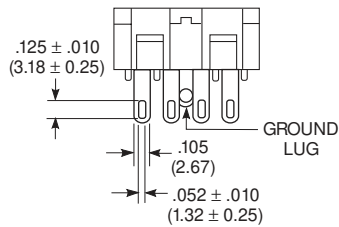

Mounting Strip 37D633

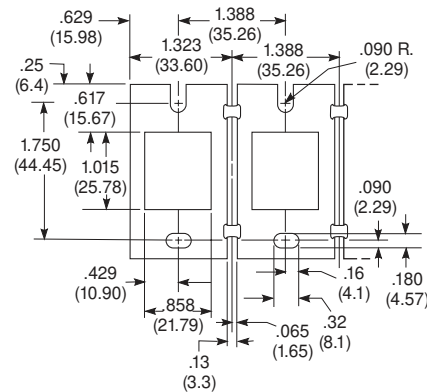

37D633 will mount eight solder terminal sockets in one length of aluminum strip measuring 10.97" x 2.25" x .062 (278.6 x 57.15 x 1.57)

Screw Terminal Socket 27E166

Relays with solder terminals are required for use with screw terminal sockets.

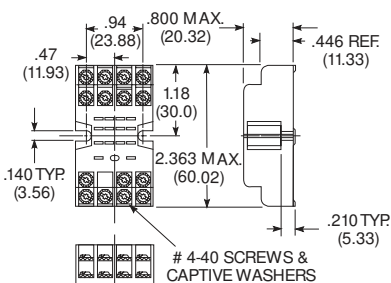

27E166 Terminal Location

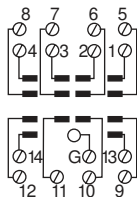

Screw Terminal DIN Rail, Snap-Mount Socket 27E894

(Use with mounting track 24A110)

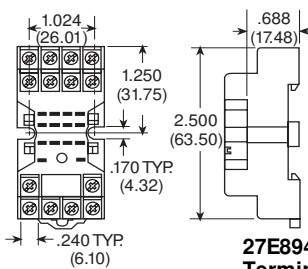

27E894 Terminal Location

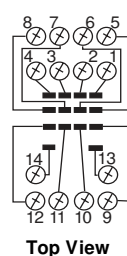

Top View

4-Pole Socket

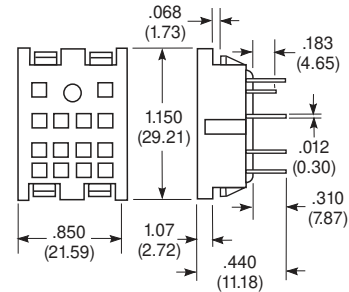

Recommended Chassis Cutouts For Mounting Sockets

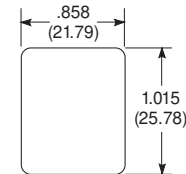

Recommended Chassis Thickness .031 (.79) to .062 (1.57)

Socket punch Greenlee part 5015115.0, Type 731R available from Greenlee Tool Co., Rockford, Illinois, (4-pole)

Printed Circuit Terminals With Grounding Lug

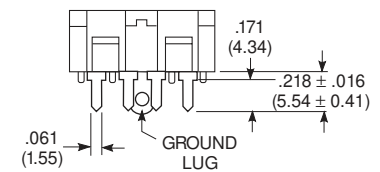

Without Grounding Lug

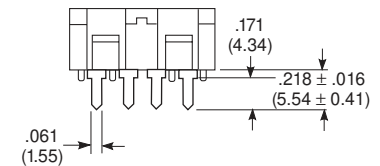

Caution: Printed circuit sockets are manufactured with "floating" (Loose) terminals. This permits them to align with holes in the circuit board and with the relay terminals. During the mounting and soldering of the socket, vertical float should be eliminated and the terminals seated on the board. (This may be accomplished by inserting a dummy relay in the socket.) Failure to eliminate float may cause fracture of the solder joint or separation of the copper conductor from the printed circuit board when a relay is inserted in the socket after soldering.

Hold Down Spring 20C217

