

## E2 Features

- Quick, simple assembly, and disassembly
- Rugged screw-together housing
- Accepts .010 in. axial shaft play
- 32 to 5,000 cycles per revolution (CPR)
- 128 to 20,000 pulses per revolution (PPR)
- 2 channel quadrature TTL squarewave outputs
- Optional index (3rd channel)
- Mounting compatibility with HEDS-5500



## E2 Product Description

The E2 is a rotary encoder with a rugged glass-filled polymer enclosure, which utilizes either a 5-pin locking or standard connector. The internal components consist of a mylar disk mounted to a precision machined aluminum hub and an encoder module. The module contains a highly collimated solid-state light source and monolithic phased array sensor, which together provide a system extremely tolerant to mechanical misalignments.



The E2 is normally designed for applications of 10 feet or less. For longer cable lengths, adding a PC4 (<https://www.usdigital.com/pc4/>) / PC5 (<https://www.usdigital.com/pc5/>) differential line driver is recommended.

Attachment of the base to a surface may be accomplished by utilizing one of several machine screw bolt circle options. Positioning of the base to the centerline of a shaft is ensured by the use of our centering tool. The cover is securely attached to the base with two 4-40 pan head screws to provide a resilient package protecting the internal components.

Connection to the E2 product is made through either a 5-pin locking or standard connector. The mating connectors are available from US Digital with several cable options and lengths.

### BROADCOM/AVAGO REPLACEMENTS:

US Digital's E2 encoder may be used as direct replacements (<https://www.usdigital.com/support/resources/reference/compatibility-guides/avago-compatibility-heds-5xxx/>) for Avago HEDM-5500, HEDM-5600, (<https://www.usdigital.com/support/resources/reference/compatibility-guides/avago-compatibility-hedm-5x0x/>) HEDS-5500, HEDS-5600 (<https://www.usdigital.com/support/resources/reference/compatibility-guides/avago-compatibility-heds-5xxx/>).

## Mechanical Drawings

## E2 Optical Kit Encoder (Default)

RELEASE DATE: 7/19/2019

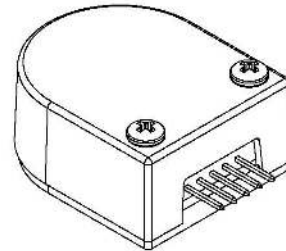
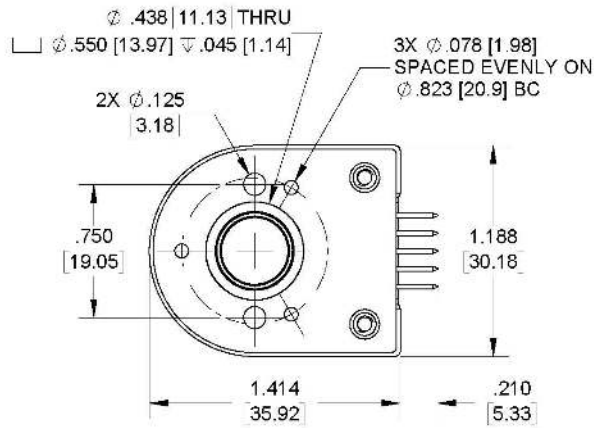
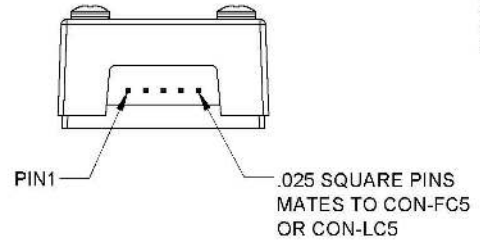
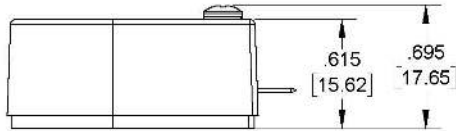

**US DIGITAL**  
 1400 NE 136th Avenue  
 Vancouver, Washington 98684, USA

info@usdigital.com  
 www.usdigital.com

Local: 360.260.2468  
 Toll-free: 800.736.0194

UNITS: INCHES [MM]  
 METRIC SHOWN FOR REFERENCE ONLY

## E2 Optical Kit Encoder (Base and Cover Options)

**E-OPTION COVER**  
(EXTENSION FOR SHAFT LENGTHS UP TO .805 [20.45])

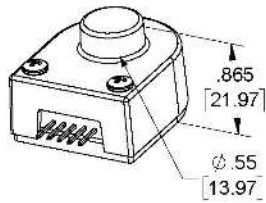

**H-OPTION COVER**  
(HOLE FOR SHAFT LENGTHS OVER .805 [20.45])

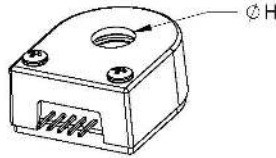

H = .375 [9.53] FOR SHAFT SIZES ≤  $\phi$ .315 [8]  
H = .500 [12.70] FOR BORE SIZES >  $\phi$ .315 [8]

**3-OPTION BASE**  
(LARGER MOUNTING HOLES)

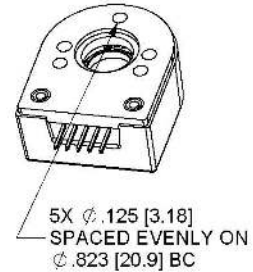

**A-OPTION BASE**  
(ALIGNMENT BOSS)

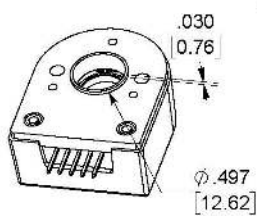

**G-OPTION BASE**  
(1.812 MOUNTING)

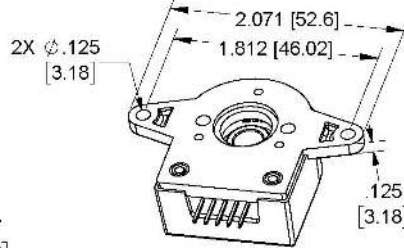

**R-OPTION BASE**  
(ROTATIONAL MOUNTING)

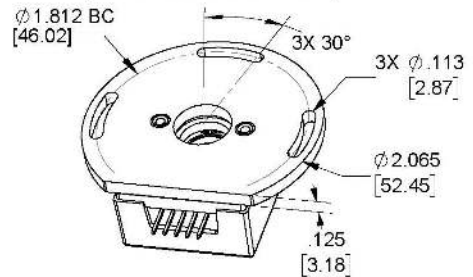

REQUIRES ADDITIONAL .125 [3.18] SHAFT LENGTH

**US DIGITAL** 1400 NE 136th Avenue  
Vancouver, Washington 98684, USA

info@usdigital.com  
www.usdigital.com

Local: 360.260.2468  
Toll-free: 800.736.0194

UNITS: INCHES [MM]  
METRIC SHOWN FOR REFERENCE ONLY

## Specifications

### ENVIRONMENTAL

PARAMETER	VALUE	UNITS
Operating Temperature, CPR < 2000	-40 to 100	C
Operating Temperature, CPR ≥ 2000	-25 to 100	C
Vibration (5Hz to 2kHz)	20	G
Electrostatic Discharge, IEC 61000-4-2	± 4	kV

### MECHANICAL



# E2 OPTICAL KIT ENCODER

PARAMETER	VALUE	UNITS
Max. Shaft Axial Play	±0.010	in.
Max. Shaft Runout	0.004 T.I.R.	in.
Max. Acceleration	250000	rad/sec <sup>2</sup>
For CPR < 2000 Max. RPM (1) (300 kHz) e.x. CPR=1250, max. rpm=14400 e.x. CPR=100, max. rpm=60000	minimum value of $((18 \times 10^6) / \text{CPR})$ and (60000)	RPM
For CPR ≥ 2000 and < 4000 Max. RPM (2) (360 kHz)	minimum value of $((21.6 \times 10^6) / \text{CPR})$ and (60000)	RPM
For CPR ≥ 4000 Max. RPM (2) (720 kHz)	minimum value of $((43.2 \times 10^6) / \text{CPR})$ and (60000)	RPM
Typical Product Weight	0.56	oz.
Codewheel Moment of Inertia	$8.0 \times 10^{-6}$	oz-in-s <sup>2</sup>
Hub Set Screw	#4-48	
Hex Wrench Size	0.050	in.
Encoder Base plate Thickness	0.135	in.
3 Mounting Screw Size	#0-80	
2 Mounting Screw Size	#2-56 or #4-40	
3 Screw Bolt Circle Diameter	$0.823 \pm 0.005$	in.
2 Screw Bolt Circle Diameter	$0.750 \pm 0.005$	in.
Required Shaft Length (2)(3) With E-option (3) With H-option	0.445 to 0.575 0.445 to 0.805 > 0.445	in. in. in.
Index Alignment to Hub Set Screw	180 Typical	degrees
Technical Bulletin TB1001 - Shaft and Bore Tolerances		Download <a href="https://www.usdigital.com/media/yyvb4qsy/tb_1001.pdf">https://www.usdigital.com/media/yyvb4qsy/tb_1001.pdf</a>

(1) 60000 rpm is the maximum rpm due to mechanical considerations. The maximum RPM due to the module's maximum frequency response is dependent upon the module's resolution (CPR). For resolutions of 32 to 1999 CPR the frequency response is 300 kHz, 2000 to 3999 CPR the frequency response is 360 kHz and 4000 CPR and greater the frequency response is 720 kHz

(2) Add 0.125" to the required shaft length when using R-option.

(3) Including Axial play.

## TORQUE SPECIFICATIONS

PARAMETER	VALUE	TORQUE
Hub Set Screw	2-3	in-lbs
Cover Screw	2-4	in-lbs
Base Mounting Screw (#0-80)	1-2	in-lbs
Base Mounting Screw (#2-56)	2-3	in-lbs
Base Mounting Screw (#4-40)	4-6	in-lbs
Adapter Plate Mounting Surface (#2-56 screws)	2-3	in-lbs
Adapter Plate Mounting Surface (#4-40 screws)	4-6	in-lbs

## PHASE RELATIONSHIP

B leads A for clockwise shaft rotation, and A leads B for counterclockwise rotation viewed from the cover side of the encoder.

## ELECTRICAL

- Specifications apply over the entire operating temperature range.
- Typical values are specified at  $V_{cc} = 5.0V_{dc}$  and  $25^{\circ}C$ .
- For complete details, see the EM1 (<https://www.usdigital.com/products/encoders/incremental/modules/em1/>) or EM2 (<https://www.usdigital.com/products/encoders/incremental/modules/em2/>) product pages.

PARAMETER	MIN.	TYP.	MAX.	UNITS	CONDITIONS
Supply Voltage	4.5	5.0	5.5	V	
Supply Current		27	33	mA	CPR < 500, no load
		54	62	mA	CPR ≥ 500 and < 2000, no load
		72	85	mA	CPR ≥ 2000, no load
Low-level Output			0.5	V	I <sub>OL</sub> = 8mA max., CPR < 2000
			0.5	V	I <sub>OL</sub> = 5mA max., CPR ≥ 2000
		0.25		V	no load, CPR ≥ 2000
High-level Output	2.0			V	I <sub>OH</sub> = -8mA max. and CPR < 2000
	2.0			V	I <sub>OH</sub> = -5mA max. and CPR ≥ 2000
		4.8		V	no load and CPR < 2000
		3.5		V	no load and CPR ≥ 2000
Output Current Per Channel	-8		8	mA	CPR < 2000
	-5		5	mA	CPR ≥ 2000
Output Rise Time		110		nS	CPR < 2000
		50		nS	CPR ≥ 2000, ± 5mA load
Output Fall Time		100		nS	CPR < 2000
		50		nS	CPR ≥ 2000, ± 5mA load

## PIN-OUT

PIN	DESCRIPTION
1	Ground
2	Index
3	A channel
4	+5VDC power
5	B channel

**Note:** 5-pin single-ended mating connector is CON-C5 (<https://www.usdigital.com/products/accessories/connectors/con-c5/>) or CON-LC5 (<https://www.usdigital.com/products/accessories/connectors/con-lc5/>)

## ACCESSORIES

### 1. Centering Tool

**Part #: CTOOL - (Shaft Diameter)**

**Description:** This reusable tool provides a simple method for accurately centering the **E2** base onto the shaft, promoting hub to base

concentricity and thus accuracy.

It is recommended for the following situations:

- When using mounting screws smaller than #4-40.
- When the position of the mounting holes is in question.
- When using the 3-hole mounting pattern.

## 2. Hex Tool

Depending on the order packaging option, either a hex driver or hex wrench is included.

**Part #: HEXD-050** (only included with **-B** or **-1** packaging options)

**Description:** Hex driver, 0.050" flat-to-flat for #4-48 set screws.

## 3. Spacer Tool

A spacer tool is included for all packaging options.

**Part #: SPACER-E2**

## 4. Screws

### Part #: SCREW-080-250-PH

Description: Pan Head, Philips #0-80 UNF x 1/4"

Use: Base Mounting

Quantity Required: 3

Screws are not included

### Part #: SCREW-256-250-PH

Description: Pan Head, Philips #2-56 UNC x 1/4"

Use: Base Mounting

Quantity Required: 2

Screws are not included

### Part #: SCREW-440-250-PH

Description: Pan Head, Philips #4-40 UNC x 1/4"

Use: Base Mounting

Quantity Required: 2

Screws are not included

### Part #: SCREW-440-625-PH

Description: Pan Head, Phillips 4-40 UNC x 5/8"

Use: Cover Mounting

Quantity Required: 2

Screws are included

### Part #: SCREW-448-063-SS

Description: Socket Head Set Screw, 4-48 UNC x 1/16"

Use: Hub/Disk Mounting for 5/16" - 10mm Bore

Quantity Required: 1

Screw is included

### Part #: SCREW-448-125-SS

Description: Socket Head Set Screw, 4-48 UNC x 1/8"

Use: Hub/Disk Mounting for 2mm - 1/4" Bore

Quantity Required: 1

Screw is included

## OUTPUT WAVEFORMS

### SINGLE-ENDED

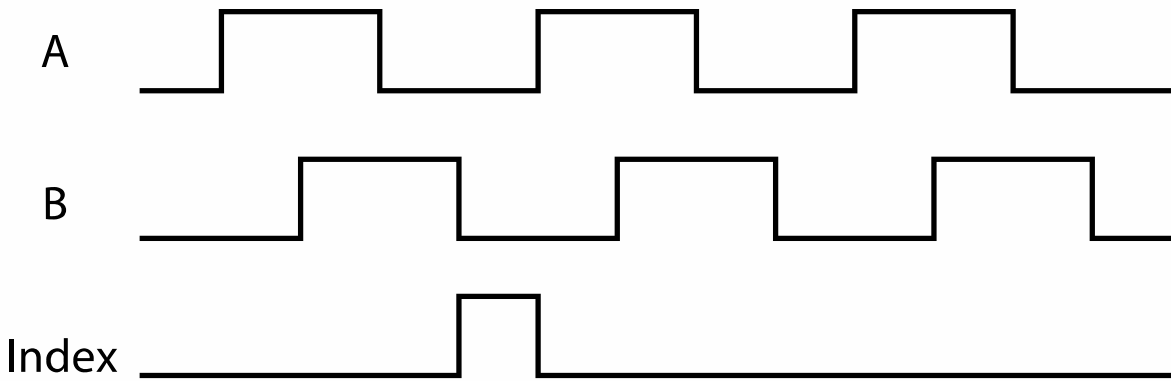

## PRODUCT CHANGE NOTIFICATIONS

Title	Date	Description	Download
E2, E5 Packaging - PCN 7190	8/31/2021	As part of our ongoing continuous improvement efforts, US Digital is implementing a change to the individual packaging options of our E2 and E5 kit encoders. It is important to note that this change will not affect the bulk packaging option, also known as our "B" packaging option.	Download ( <a href="https://www.usdigital.com/media/ynclhhlf/e2-e5-packaging-pcn-7190.pdf">https://www.usdigital.com/media/ynclhhlf/e2-e5-packaging-pcn-7190.pdf</a> )
HUBDISK-1 Packaging Change Notification - PCN 6297	4/30/2018	<p>As part of our ongoing continuous improvement efforts, US Digital is implementing a change to the packaging of our 1-inch Hubdisk assemblies.</p> <p>We are replacing the current plastic tube packaging with a 25-count plastic tray. The tray is a two-piece design with a snap-on lid and anti-static coated for ESD-sensitive environments. This change is designed to enhance the ease of handling for our customers, easy removal of the individual hubdisk, and protection against potential damage due to long-term storage of hubdisk assemblies.</p> <p>This change does not affect the form, fit, or function of the final product.</p>	Download ( <a href="https://www.usdigital.com/media/oetpzqhe/pcn-6297-hubdisk-1-packaging.pdf">https://www.usdigital.com/media/oetpzqhe/pcn-6297-hubdisk-1-packaging.pdf</a> )



<p>Hub Set Screw Production Change - PCN 5367</p>	<p>7/20/2015</p>	<p>As part of our ongoing continuous improvement efforts, US Digital is implementing a change related to the production of our 5/16" (.313), 8mm (.315), 3/8" (.375), and 10mm (.394) HUBDISK assemblies. We are adding a low-strength threadlocker to the set screw during our assembly process to assist in securing the set screw in the hub during transportation. This will aid in the set screw retention of these specific hub sizes; ensuring the retention is sufficient and avoid the potential of them backing out of the hub assembly during transit. This change does not affect form, fit, or function.</p>	<p>Download (<a href="https://www.usdigital.com/media/ctrc03di/hub-set-screw-pcn-5367.pdf">https://www.usdigital.com/media/ctrc03di/hub-set-screw-pcn-5367.pdf</a>)</p>
<p>E2 Mold Update - PCN 5258</p>	<p>4/22/2015</p>	<p>As part of our ongoing continuous improvement efforts, and in order to enhance both function and appearance of the E2 product line, multiple improvements are being incorporated into a plastic component redesign.</p> <ul style="list-style-type: none"> <li>• Download the revised E2 Assembly Instructions (<a href="https://www.usdigital.com/media/uouc5ewg/e2-assembly-instructions.pdf">https://www.usdigital.com/media/uouc5ewg/e2-assembly-instructions.pdf</a>)</li> <li>• Download the revised E2 Mechanical Drawing (<a href="https://www.usdigital.com/media/4ucf1z1r/29625.pdf">https://www.usdigital.com/media/4ucf1z1r/29625.pdf</a>)</li> <li>• Download the revised E2 Mechanical Drawing (options) (<a href="https://www.usdigital.com/media/lf5pbem0/24916.pdf">https://www.usdigital.com/media/lf5pbem0/24916.pdf</a>)</li> <li>• Download the revised 3D models (samples)</li> </ul>	<p>Download (<a href="https://www.usdigital.com/media/xyobebhl/e2-mold-update-pcn5258_v2.pdf">https://www.usdigital.com/media/xyobebhl/e2-mold-update-pcn5258_v2.pdf</a>)</p>
<p>EM1 &amp; EM2 Update - PCN 4199</p>	<p>1/14/2014</p>	<p>Based on our continuous process improvement program, US Digital is changing the current marking method for our EM1 and EM2 encoder modules to a serialization method. This change will allow for each module to have a unique code; the current marking method is based on a date code system that includes all encoder modules produced within a specific week/year. The serialization system will be based on a hexadecimal system.</p>	<p>Download (<a href="https://www.usdigital.com/support/resources/product-change-notifications/pcn-4199-em1-em2-update/">https://www.usdigital.com/support/resources/product-change-notifications/pcn-4199-em1-em2-update/</a>)</p>
<p>EM1 LED Die - PCN 1016</p>	<p>2/7/2013</p>	<p>As part of US Digital's continual assurance of supply strategy, we have qualified additional sources for our LED die used in our EM1 encoder module, which in turn impacts all of the following products:</p> <p>EM1, E2, E3, E5, E6, H1, H15, H3, H5, H6, HB5M, HB6M, HD25, PE, S1, S2, S5, S6, T5 and T6</p> <p>The device specification will remain the same, i.e. there will be no change to form, fit, or function of the product(s) as specified by US Digital. The appropriate quality and reliability testing have been performed on representative products to ensure normal parametric distribution, consistent with US Digital's quality and reliability standards.</p>	<p>Download (<a href="https://www.usdigital.com/support/resources/product-change-notifications/pcn-1016-em1-led-die/">https://www.usdigital.com/support/resources/product-change-notifications/pcn-1016-em1-led-die/</a>)</p>

## Notes

- US Digital® warrants its products against defects in materials and workmanship for two years. See complete warranty (<https://www.usdigital.com/company/warranty>) for details.
- Cables and connectors are not included and must be ordered separately.