

Integrated Transceiver Modules for ZigBee / 802.15.4 (900 MHz) Development Kit Available

FEATURES

- 250mW output power
- Long range: 2 miles
- Up to 1Mbps RF data rate
- Miniature footprint: 0.9" x 1.63"
- Multiple antenna options
- Agency Approvals: FCC and IC
- Powerful Atmel 256k ATXMEGA256A3 with 802.15.4 MAC or ZigBee Stack
- LSR serial interface based on 802.15.4 MAC
- Low power operation
- RoHS compliant
- Streamlined development with LSR design services.
- License options available to purchase design or integrate design.

APPLICATIONS

- Security
- Lighting Control
- HVAC Control
- Sensor Networks
- Medical
- Industrial Automation

DESCRIPTION

The SiFLEX02 module is a high performance 900MHz IEEE 802.15.4 radio (AT86RF212 & RF amplifier circuit) and microcontroller (ATXMEGA256A3) in a cost effective, pre-certified footprint.



The module comes preloaded with the LSR host serial interface running on top of the Atmel 802.15.4 MAC.

Full debug and programming capabilities are included to develop custom applications. Easily load the ZigBee stack or 802.15.4 MAC onto the module and create your own network.

Need to get to market quickly? Not an expert in 802.15.4 or ZigBee? Need a custom antenna? Would you like to own the design? Would you like a custom design? Not quite sure what you need? Do you need help with your host board? LS Research Design Services will be happy to develop custom hardware or software, integrate the design, or license the design so you can manufacture yourself. Contact us at sales@lsr.com or call us at 262-375-4400.

ORDERING INFORMATION

Order Number	Description
450-0016	SiFLEX02 Module with U.FL connector for external antenna. (Tray) SPQ = 25, MOQ = 50
450-0017	SiFLEX02 Module with wire antenna. (Tray) SPQ = 25, MOQ = 50
450-0018	SiFLEX02 Module with helical antenna. (Tray) SPQ = 25, MOQ = 50
450-0019	SiFLEX02 Module with RF castellation for off board antenna. Note: See Antenna Options section for more details. (Tray) SPQ = 25, MOQ = 50
450-0021	SiFLEX02 Development Kit with wire antenna.

Table 1 Orderable SiFLEX02 Model Numbers

The information in this document is subject to change without notice.

MODULE ACCESSORIES



	Order Number	Description
	001-0002	900 MHz Dipole Antenna with Reverse Polarity SMA Connector
	080-0001	U.FL to Reverse Polarity SMA Bulkhead Cable 105mm

Table 2 Module Accessories

BLOCK DIAGRAM

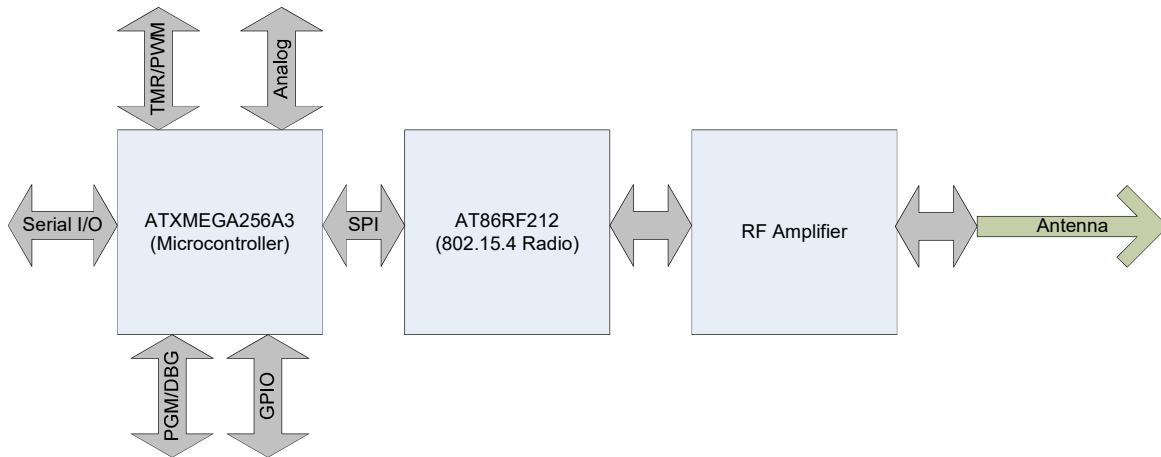

Figure 1 SiFLEX02 Module Block Diagram – High-Level

DEVELOPMENT KIT

The SiFLEX02 Development Kit can be used out of the box to evaluate RF range performance with the simple press of a button.

Users interested in further investigating the performance and capabilities of the SiFLEX02 Module can use the ModFLEX™ Test Tool. This PC-based software can demonstrate just how easy it is to send & receive data, collect performance data, change channels, power levels, or addresses using the LSR Serial Host Protocol with another microcontroller.

More advanced users can use the development board to create and debug their own software for the SiFLEX02 module using the 802.15.4 MAC or ZigBee stack from Atmel.

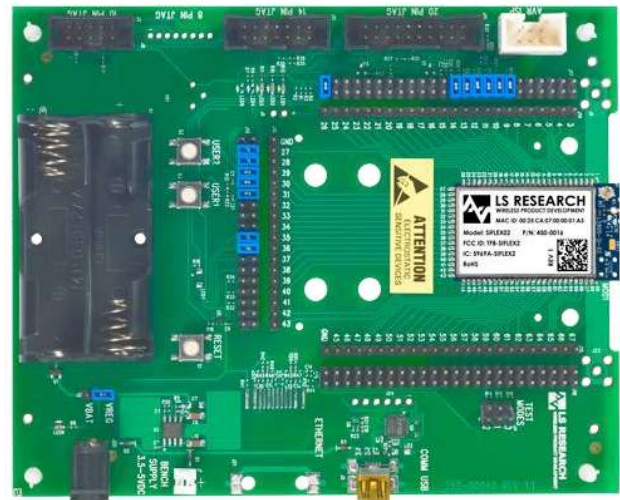

Figure 2 SiFLEX02 Development Board

Part Number	Description
450-0021	SiFLEX02 Development Kit

Kit Contents

- ModFLEX™ Development Board with SiFLEX02 Module with Wire antenna (x2)
- USB Cable (x2)
- AA Batteries (x4)
- Quick Start Guide

TABLE OF CONTENTS

FEATURES	1
APPLICATIONS.....	1
DESCRIPTION	1
ORDERING INFORMATION	1
MODULE ACCESSORIES	2
BLOCK DIAGRAM.....	3
DEVELOPMENT KIT.....	3
Kit Contents	3
MODULE PINOUT AND PIN DESCRIPTIONS	6
MODULE OVERVIEW.....	10
Microcontroller	10
Radio	12
RF Power Amplifier	13
Antenna Options	14
MODES OF OPERATION	15
Host Microcontroller	15
Software Stacks	15
DEVELOPMENT TOOLS	17
AVR Studio.....	17
WinAVR	17
AVR JTAGICE mkII.....	17
AVRISP mkII.....	17
IAR Embedded Workbench for Atmel AVR	17
ELECTRICAL SPECIFICATIONS	18
Absolute Maximum Ratings.....	18
Recommended Operating Conditions	18
General Characteristics	19
RF Characteristics	20
SOLDERING RECOMMENDATIONS	22

The information in this document is subject to change without notice.

Recommended Reflow Profile for Lead Free Solder	22
CLEANING	23
OPTICAL INSPECTION	23
REWORK	23
SHIPPING, HANDLING, AND STORAGE	23
Shipping	23
Handling	23
Moisture Sensitivity Level (MSL)	23
Storage	23
Repeating Reflow Soldering	24
AGENCY STATEMENTS	25
ANTENNA INFORMATION	29
Wire Antenna (Perpendicular to Board as in Figure 16)	29
Helical Antenna	30
MECHANICAL DATA.....	31
PCB Footprint	31
General Module Dimensions.....	32
Module with Wire Antenna	33
Module with Helical Antenna	34
COMPATIBILITY.....	35
MODULE REVISION HISTORY	36
Rev 1.0.....	36
Rev 1.1.....	36
Rev 1.3.....	37
Rev 2.0.....	38
Rev 3.0.....	39
CONTACTING LS RESEARCH	40

Module Pin	Name	MCU Pin	Type	Description
1	GND	N/A	GND	Ground
2	GND	N/A	GND	Ground
3	GND	N/A	GND	Ground
4	NC	N/A	NC	No Connect
5	NC	N/A	NC	No Connect
6	NC	N/A	NC	No Connect
7	NC	N/A	NC	No Connect
8	NC	N/A	NC	No Connect
9	JTAG TMS	10	I/O	General-purpose digital I/O (PB4), Analog input, JTAG TMS
10	JTAG TDI	11	I/O	General-purpose digital I/O (PB5), Analog input, JTAG TDI
11	JTAG TCK	12	I/O	General-purpose digital I/O (PB6), Analog input, JTAG TCK
12	JTAG TDO	13	I/O	General-purpose digital I/O (PB7), Analog input, JTAG TDO
13	JTAG/PDI/JRST	56	I/O	PDI/PDI_DATA
14	nRESET	57	Input	RESET/PDI_CLOCK
15	PA0	62	I/O	General-purpose digital I/O, Analog input, Analog REF A
16	PB0	6	I/O	General-purpose digital I/O, Analog input, Analog REF B
17	PA2	64	I/O	General-purpose digital I/O, Analog input, Analog comparator 2
18	PA1	63	I/O	General-purpose digital I/O, Analog input, Analog comparator 1
19	PA7	5	I/O	General-purpose digital I/O, Analog input, Analog comparator output
20	PA4	2	I/O	General-purpose digital I/O, Analog input
21	PA5	3	I/O	General-purpose digital I/O, Analog input
22	PA6	4	I/O	General-purpose digital I/O, Analog input
23	PB1	7	I/O	General-purpose digital I/O, Analog input
24	PB2	8	I/O	General-purpose digital I/O, Analog input
25	PB3	9	I/O	General-purpose digital I/O, Analog input
26	VCC - 3V3DC	VCC	VCC	Supply Voltage
27	PF3	49	I/O	General-purpose digital I/O, Output Compare, UART Tx
28	PF2	48	I/O	General-purpose digital I/O, Output Compare, UART Rx
29	PF1	47	I/O	General-purpose digital I/O, Output Compare, UART XCK0
30	PF0	46	I/O	General-purpose digital I/O, Output Compare

The information in this document is subject to change without notice.

Module Pin	Name	MCU Pin	Type	Description
31	PE5	41	I/O	General-purpose digital I/O, Output Compare, UART XCK1, SPI MOSI
32	PE4	40	I/O	General-purpose digital I/O, Output Compare, SPI SS
33	PE3	39	I/O	General-purpose digital I/O, Output Compare, UART Tx
34	PE2	38	I/O	General-purpose digital I/O, Output Compare, UART Rx
35	PC3, UART TX	19	I/O	General-purpose digital I/O, Output Compare, UART Tx
36	PC2, UART RX	18	I/O	General-purpose digital I/O, Output Compare, UART Rx
37	PC1	17	I/O	General-purpose digital I/O, Output Compare, IIC SCL
38	PC0	16	I/O	General-purpose digital I/O, Output Compare, IIC SDA
39	PF5	51	I/O	General-purpose digital I/O
40	PF6	54	I/O	General-purpose digital I/O
41	PF7	55	I/O	General-purpose digital I/O
42	PA3	1	I/O	General-purpose digital I/O, Analog input
43	NC	N/A	NC	No Connect
44	GND	N/A	GND	Ground
45	NC	N/A	NC	No Connect
46	NC	N/A	NC	No Connect
47	NC	N/A	NC	No Connect
48	NC	N/A	NC	No Connect
49	NC	N/A	NC	No Connect
50	NC	N/A	NC	No Connect
51	NC	N/A	NC	No Connect
52	NC	N/A	NC	No Connect
53	NC	N/A	NC	No Connect
54	NC	N/A	NC	No Connect
55	NC	N/A	NC	No Connect
56	PE1	37	I/O	General-purpose digital I/O, Output Compare, IIC SCL
57	PE0	36	I/O	General-purpose digital I/O, Output Compare, IIC SDA
58	PC4	20	I/O	General-purpose digital I/O, Output Compare, SPI SS
59	PC7	23	I/O	General-purpose digital I/O, Output Compare, UART Tx, SPI SCK
60	PC6	22	I/O	General-purpose digital I/O, Output Compare, UART Rx, SPI MISO

The information in this document is subject to change without notice.

Module Pin	Name	MCU Pin	Type	Description
61	PC5	21	I/O	General-purpose digital I/O, Output Compare, UART XCK1, SPI MOSI
62	NC	N/A	NC	No Connect
63	NC	N/A	NC	No Connect
64	NC	N/A	NC	No Connect
65	NC	N/A	NC	No Connect
66	NC	N/A	NC	No Connect
67	GND	N/A	GND	Ground
68	GND	N/A	GND	Ground
69	GND	N/A	GND	Ground

Table 3 SiFLEX02 Module Pin Descriptions

MODULE OVERVIEW

Figure 4 shows the internal interconnects of the ICs on the SiFLEX02 module. Consult the respective IC datasheets for details, or contact LSR sales to purchase the SiFLEX02 module schematics as part of LSR’s ModFLEX™ design program. For a high-level block diagram of the SiFLEX02 module, see Figure 1.

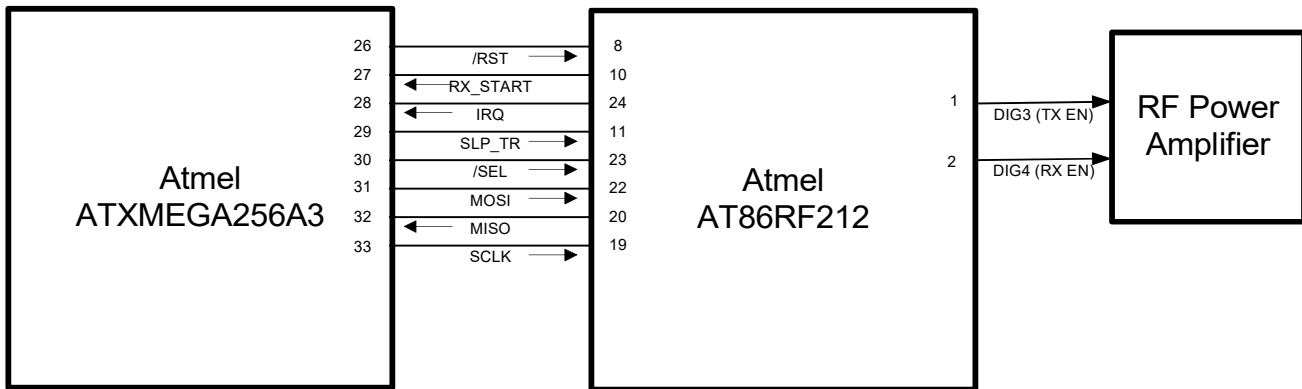

Figure 4 SiFLEX02 Module Block Diagram – Internal Interconnects

Microcontroller

The XMEGA A3 is a family of low power, high performance and peripheral rich CMOS 8/16-bit microcontrollers based on the AVR® enhanced RISC architecture. By executing powerful instructions in a single clock cycle, the XMEGA A3 achieves throughputs approaching 1 Million Instructions Per Second (MIPS), thus allowing the system designer to optimize power consumption versus processing speed. Figure 5 shows a block diagram of the ATXMEGA256A3.

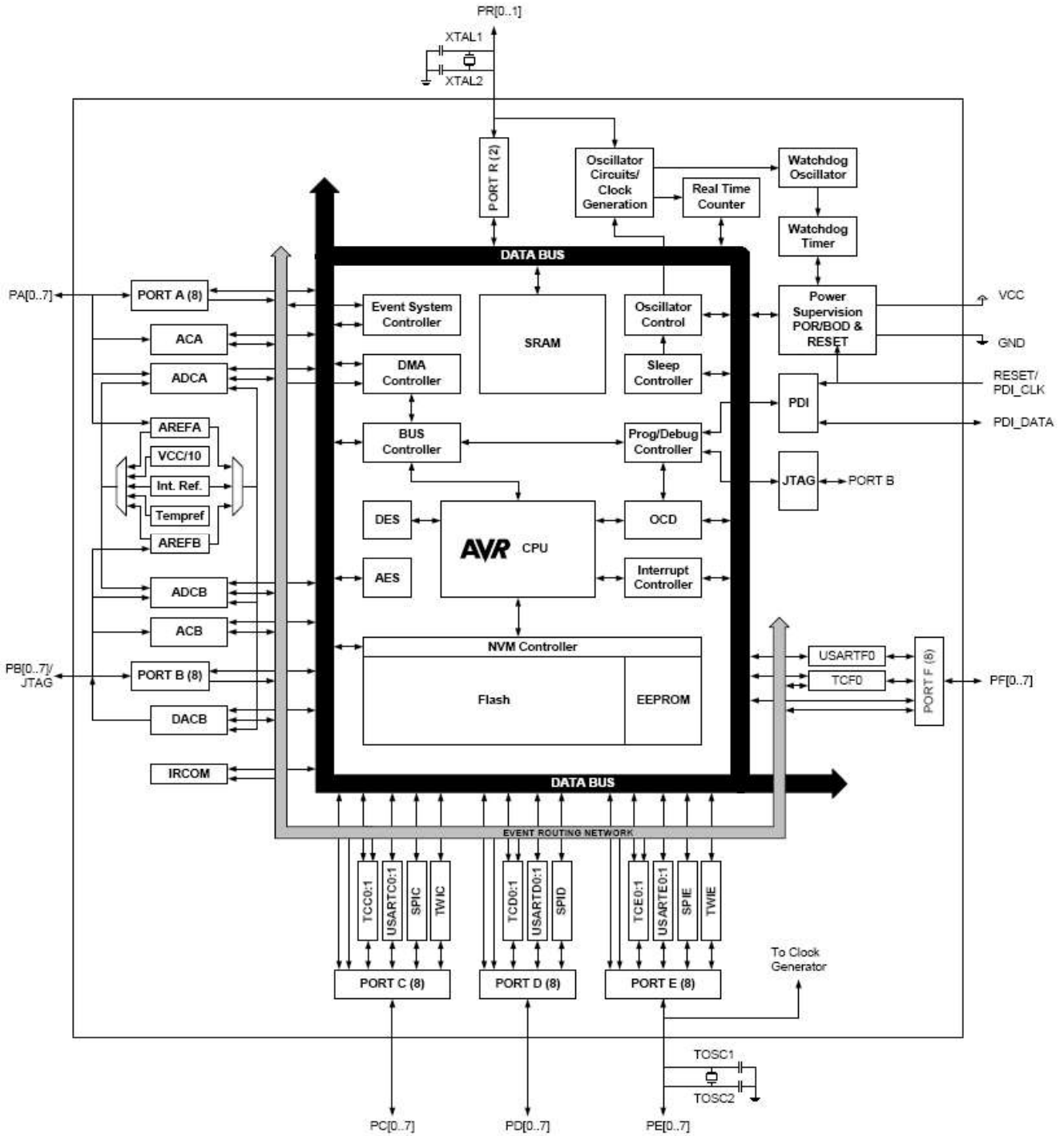

Figure 5 ATXMEGA256A3 Block Diagram

The AVR CPU combines a rich instruction set with 32 general purpose working registers. All the 32 registers are directly connected to the Arithmetic Logic Unit (ALU), allowing two independent registers to be accessed in one single instruction, executed in one clock cycle. The resulting architecture is more code efficient while achieving throughputs many times faster than conventional single-accumulator or CISC based microcontrollers.

The XMEGA A3 devices have five software selectable power saving modes. The Idle mode stops the CPU while allowing the SRAM, DMA Controller, Event System, Interrupt Controller and all peripherals to continue functioning. The Power-down mode saves the SRAM and register contents but stops the oscillators, disabling all other functions until the next TWI or pin-change interrupt, or Reset. In Power-save mode, the asynchronous Real Time Counter continues to run, allowing the application to maintain a timer base while the rest of the device is sleeping. In Standby mode, the Crystal/Resonator Oscillator is kept running while the rest of the device is sleeping. This allows very fast start-up from external crystal combined with low power consumption. In Extended Standby mode, both the main Oscillator and the Asynchronous Timer continue to run. To further reduce power consumption, the peripheral clock for each individual peripheral can optionally be stopped in Active mode and Idle sleep mode.

Radio

The AT86RF212 is a low-power, low-voltage 800/900 MHz transceiver specially designed for low-cost IEEE 802.15.4, ZigBee™, and high data rate ISM applications. For the sub-1 GHz bands, it supports a low data rate of 40kbps of the IEEE 802.15.4-2003 standard [2] and provides an optional data rate 250kbps using O-QPSK, according to IEEE 802.15.4-2006. Furthermore hardware accelerators improve overall system power efficiency and timing.

The receiver path is based on a low-IF architecture. After channel filtering and down conversion the low-IF signal is sampled and applied to the digital signal processing part. Communication between transmitter and receiver is based on direct sequence spread spectrum with different modulation schemes and spreading codes. The AT86RF212 supports the IEEE 802.15.4-2006 standard mandatory BPSK modulation and optional O-QPSK modulation in the 800 and 900 MHz band. For applications not necessarily targeting IEEE compliant networks the radio transceiver supports proprietary High Data Rate Modes based on O-QPSK.

The AT86RF212 features hardware supported 128 bit security operation. The standalone AES encryption/decryption engine can be accessed in parallel to all PHY operational modes. Configuration of the AT86RF212, reading, and writing of data memory as well as the AES hardware engine are controlled by the SPI interface and additional control signals.

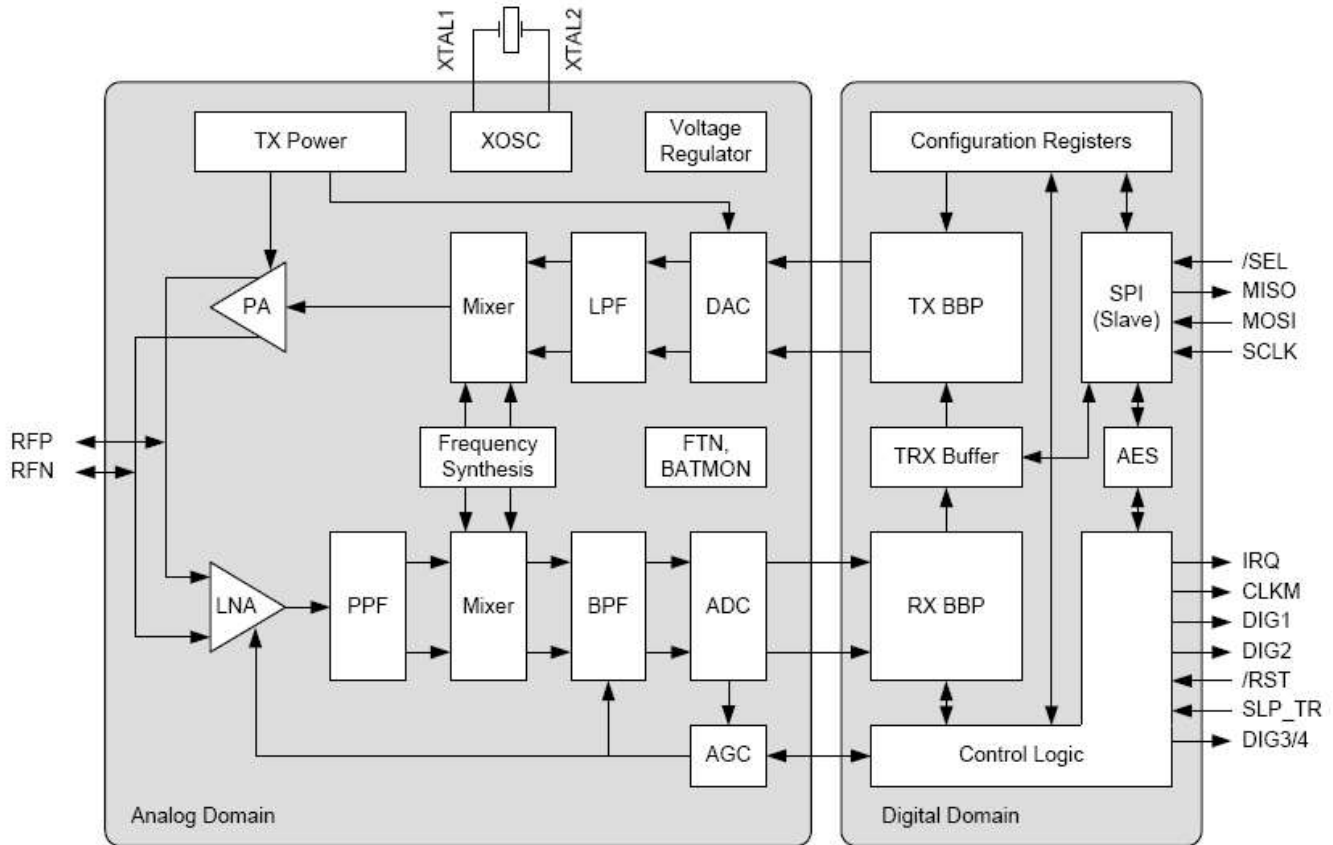

Figure 6 AT86RF212 Block Diagram

RF Power Amplifier

The SiFLEX02 module contains a discrete high performance RF Front End for low-power and low-voltage 900MHz wireless applications. It is capable of 250mW output power, providing miles of range in outdoor applications.

The signals DIG3 and DIG4 from the RF212 radio are used for transmit enable (TXEN) and receive enable (RXEN) respectively. When transmitting the DIG3 signal will be high and DIG4 will be low, which is controlled by the RF212. When receiving DIG3 will be low and DIG4 is high. In order to configure this functionality, the PA_EXT_EN bit in register TRX_CTRL_1 (0x04) of the RF212 needs to be set as a one. In addition the bits PA_LT[1] and PA_LT[0] in register RF_CTRL_0 (0x16) should both be set to one to maximize the PA lead time to 8usec.

When putting the module to sleep the PA_EXT_EN bit should be set as zero. Upon wakeup the PA_EXT_EN should be set back to one.

Antenna Options

The SiFLEX02 module includes multiple antenna options. The module's regulatory certification has been completed with the following antennas:

- Integrated 3.2-inch wire monopole soldered to the board.
- Pulse W3112A helical antenna
- LSR 001-0002 900 MHz Dipole Antenna with Reverse Polarity SMA Connector and LSR 080-0001 u.fl to Reverse Polarity SMA Bulkhead Cable 105mm
- Nearson S467AH-915 dipole antenna attached to the board via 6-inch cable with connector.

The SiFLEX02 RF castellation for off board antenna is not covered in the modular certification. If a host board is designed that will utilize an off board antenna via the castellated antenna connection an additional certification will be required. LS Research is equipped with a certification lab and can assist in getting this done at a very reasonable cost in a short period of time.

An adequate ground plane is necessary to provide good efficiency. The ground plane of the host board on which the module is mounted increases the effective antenna ground plane size and improves the antenna performance.

The environment the module is placed in will dictate the range performance. The non-ideal characteristics of the environment will result in the transmitted signal being reflected, diffracted, and scattered. All of these factors randomly combine to create extremely complex scenarios that will affect the link range in various ways.

It is also best to keep some clearance between the antenna and nearby objects. This includes how the module is mounted in the product enclosure. Unless the items on the following list of recommendations are met, the radiation pattern can be heavily distorted.

Whichever antenna is used, it is best to keep a few things in mind when determining its location.

- Never place ground plane or copper trace routing underneath the antenna.
- LSR recommends keeping metal objects as far away from the antenna as possible. At a very minimum keep the antenna at least 5 cm from any metallic objects, components, or wiring. The farther the antenna is placed from these interferers, the less the radiation pattern and gain will be perturbed.
- Do not embed the antenna in a metallic or metalized plastic enclosure.
- If located within a plastic enclosure, keep the enclosure at least 1 cm from the antenna.

MODES OF OPERATION

- With a host microcontroller
- With the Atmel 802.15.4 MAC
- With the Atmel ZigBee stack

Host Microcontroller

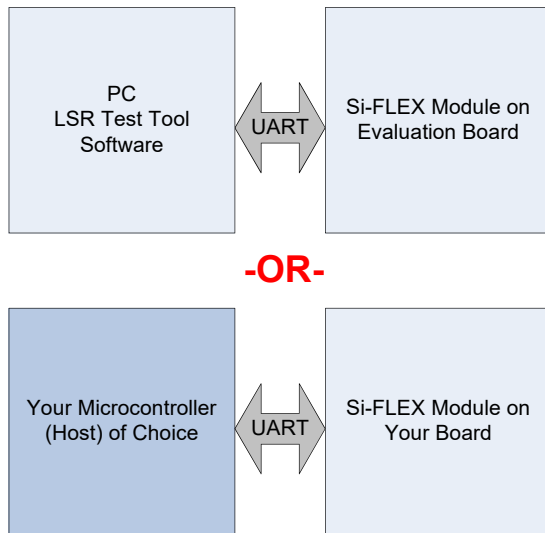

Figure 7 Host Microcontroller Modes of Operation

Out of the box the SiFLEX02 module contains an 802.15.4 based application that uses a host serial processor. This allows features of the module to be explored with the LSR PC based test tool, or controlled with a host microcontroller. The advantage of this method is simplicity; all major features of using the radio are simplified into a simple serial message, taking the burden of becoming a radio expert off the developer.

Use the Communications Log in the ModFLEX™ Test Tool software and serial host protocol documents to see the messages in action. It will help you become familiar with the serial commands and how to implement them on your own microcontroller.

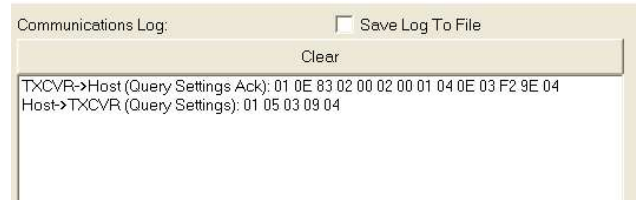

Figure 8 ModFLEX™ Test Tool Communications Log

Some examples of serial commands that can be used with the SiFLEX02 Module:

- Set/Query RF channel
- Set/Query RF power
- Set/Query device address
- Transmit RF data or notification RF data received
- Go to Sleep

Software Stacks

There are two software stacks provided by Atmel to streamline development:

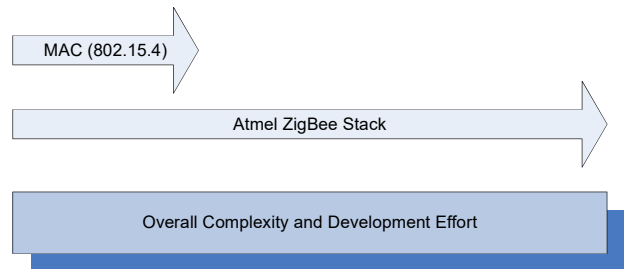

Figure 9 SiFLEX02 Compatible Stacks

802.15.4 MAC

- Use for applications requiring point-to-point or star network topology.
- Advantages: Quick learning curve, minimize software development, easy to deploy in the field
- Disadvantages: No mesh networking

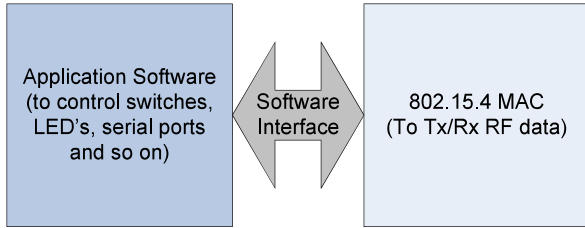

Figure 10 SiFLEX02 with 802.15.4 MAC

Atmel ZigBee Stack

- Use when mesh networking is required.

- Advantages: Covers a large area with a ZigBee network.
- Disadvantages: Large learning curve, more software development, complexity

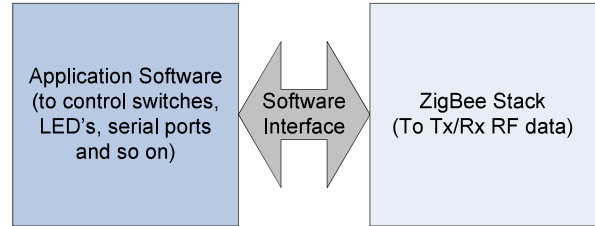

Figure 11 SiFLEX02 with Atmel ZigBee Stack

DEVELOPMENT TOOLS

AVR Studio

AVR Studio® is an Integrated Development Environment (IDE) for writing and debugging AVR® applications. AVR Studio includes an assembler, simulator, and in-circuit debugger.

AVR Studio is the Integrated Development Environment (IDE) developed by Atmel for writing and debugging Atmel AVR applications.

WinAVR

WinAVR is a suite of executable, open source software development tools for the Atmel AVR series of RISC microprocessors hosted on the Windows platform. It includes the GNU GCC compiler for C/C++.

WinAVR contains all the tools for developing on AVR family microcontrollers from Atmel. This includes avr-gcc (compiler), avrdude (programmer), avr-gdb (debugger), and more.

AVR JTAGICE mkII

Custom firmware development can be done on the SiFLEX02 module using development tools available through Atmel. Shown in Figure 12, a JTAGICE mkII interface is required. It plugs into the ModFLEX™ Development Board, and can easily be adapted to other hardware. See the Atmel website for more information and ordering options.



Figure 12 JTAGICE mkII

AVRISP mkII

Another option for in-circuit programming is the AVRISP mkII from Atmel, Figure 13. The AVRISP mkII combined with AVR Studio® can program new AVR 8-bit RISC microcontrollers with ISP Interface.



Figure 13 AVRISP mkII

IAR Embedded Workbench for Atmel AVR

Another option is IAR Embedded Workbench for Atmel AVR. IAR Embedded Workbench for AVR is an integrated development environment for building and debugging embedded applications. Visit the IAR Systems website for additional information.

ELECTRICAL SPECIFICATIONS

The majority of these characteristics are based on the use of the Atmel IEEE 802.15.4 MAC loaded with the generic application firmware written by LSR. Custom firmware may require these values to be re-characterized by the customer.

Absolute Maximum Ratings

Rating	Min	Max	Unit
Power supply voltage	0	3.6	V
Voltage on any pin with respect to ground	-0.3	$V_{CC} + 0.3$	V
RF input power		+10	dBm
Operating temperature range	-40	+85	°C
Storage temperature	-50	+150	°C

Table 4 Absolute Maximum Ratings¹

Recommended Operating Conditions

Characteristic	Min	Typ	Max	Unit
Power supply voltage (V_{CC})	2.0	3.3	3.45	Vdc
Ambient temperature range	-40	25	85	°C

Table 5 Recommended Operating Conditions

Module will NOT transmit, if $V_{CC} > 3.5V$.

¹ Under no circumstances should exceeding the maximum ratings specified in the Absolute Maximum Ratings section be allowed. Stressing the module beyond these limits may result permanent damage to the module that is not covered by the warranty.

General Characteristics

Parameter	Min	Typ	Max	Unit
RF frequency range	906		924	MHz
RF data rate	40		1000	kbps
Host data rate	1.2	19.2	921.6	kbps
Flash memory		256		kBytes
RAM		16		kBytes
EEPROM		4		kBytes

Table 6 General Characteristics

Power Consumption

($T_A = 25^\circ\text{C}$, $V_{CC} = 3.3\text{V}$, $f_c = 906\text{-}924\text{MHz}$, $R_{load} = 50\Omega$)

Parameter	Test Conditions	Min	Typ	Max	Unit
Transmit mode	Maximum power step	270	285	300	mA
Receive mode		27	30	33	mA
Sleep mode			2	5	μA

Table 7 Power Consumption

DC Characteristics – General Purpose I/O

Parameter	Test Conditions	Min	Typ	Max	Unit
Logic input low		-0.3		$0.2 * V_{CC}$	V
Logic input high		$0.8 * V_{CC}$		$V_{CC} + 0.3$	V
Logic output low	$I_{OUT} = 15\text{mA}$ $V_{CC} = 3.3\text{V}$		0.4		V
Logic output high	$I_{OUT} = -8\text{mA}$ $V_{CC} = 3.3\text{V}$		2.9		V

Table 8 DC Characteristics – General Purpose I/O

RF Characteristics

Transmitter Characteristics

($T_A = 25^\circ\text{C}$, $V_{CC} = 3.3\text{V}$, $f_c = 906\text{-}924\text{ MHz}$)

Parameter	Test Conditions	Min	Typ	Max	Unit
Nominal max output power	250mW	22	24.0	25	dBm
Programmable output power range	22 Steps	-6.0		25	dBm
Harmonics (2fo)			-34		dBm
Harmonics (3fo)			-38		dBm
Error vector magnitude			10	35	% rms

Table 9 Transmitter RF Characteristics

Host Protocol RF Power Level	AT86RF212 PHY_TX_PWR Register Value	BPSK into 50 ohms at u.fl		OQPSK into 50 ohms at u.fl	
		RF Output Power (dBm)	Typical Current Consumption (mA)	RF Output Power (dBm)	Typical Current Consumption (mA)
21	0xE0	23.9	260	24.4	285
20	0xE1	23.8	255	24.3	275
19	0xE2	23.4	245	24.0	270
18	0xE3	23.0	235	23.5	260
17	0x83	21.8	200	22.0	220
16	0x60	20.7	185	20.7	195
15	0x61	20.0	175	20.0	185
14	0x41	19.5	165	19.5	175
13	0x42	18.6	150	18.5	160
12	0x22	17.6	140	17.5	145
11	0x23	16.2	125	16.0	130
10	0x02	15.6	120	15.0	120
9	0x03	14.0	105	13.0	105
8	0x04	12.0	95	10.5	90
7	0x05	9.0	80	8.0	80
6	0x06	7.0	75	5.0	70
5	0x07	4.5	68	2.5	65
4	0x08	1.0	62	0.0	61
3	0x09	-1.5	59	-3.0	57
2	0x0A	-4.0	57	-5.0	55
1	0x0B	-6.0	55	-7.0	54
0	0x0C	-8.0	54	-9.0	53

Table 10 RF Power Settings
Receiver Characteristics
 ($T_A = 25^\circ\text{C}$, $V_{CC} = 3.3\text{V}$, $f_c = 906\text{-}924\text{ MHz}$)

Parameter	Test Conditions	Min	Typ	Max	Unit
Receiver Sensitivity @ 1% PER	BPSK 40kbit/s		-102		dBm
Saturation Level @ 1% PER	BPSK 40kbit/s		-2		dBm

Table 11 Receiver RF Characteristics

For additional details regarding the electrical specifications, refer to the ATXMEGA256A3 and AT86RF212 datasheets on the Atmel website.

SOLDERING RECOMMENDATIONS

Recommended Reflow Profile for Lead Free Solder

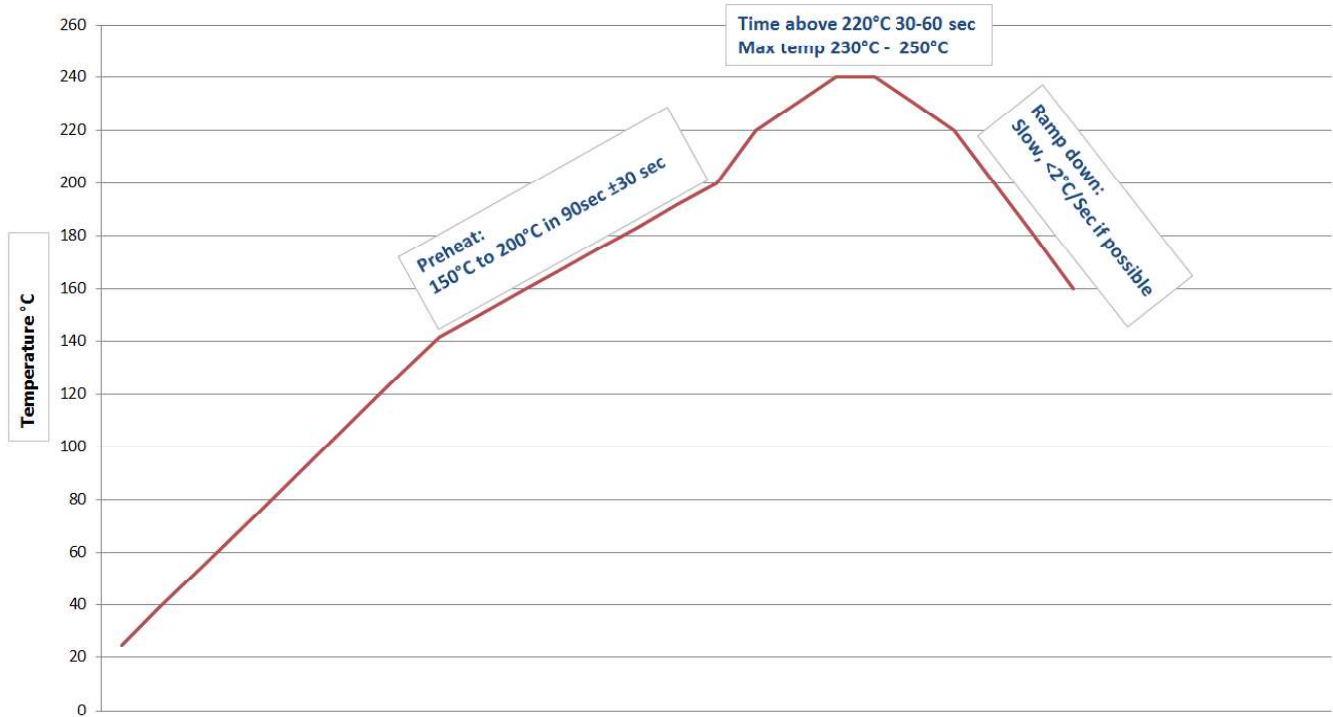

Note: The quality of solder joints on the castellations ('half vias') where they contact the host board should meet the appropriate IPC Specification. See IPC-A-610-D Acceptability of Electronic Assemblies, section 8.2.4 Castellated Terminations."

CLEANING

In general, cleaning the populated modules is strongly discouraged. Residuals under the module cannot be easily removed with any cleaning process.

- Cleaning with water can lead to capillary effects where water is absorbed into the gap between the host board and the module. The combination of soldering flux residuals and encapsulated water could lead to short circuits between neighboring pads. Water could also damage any stickers or labels.
- Cleaning with alcohol or a similar organic solvent will likely flood soldering flux residuals into the RF shield, which is not accessible for post-washing inspection. The solvent could also damage any stickers or labels.
- Ultrasonic cleaning could damage the module permanently.

OPTICAL INSPECTION

After soldering the Module to the host board, consider optical inspection to check the following:

- Proper alignment and centering of the module over the pads.
- Proper solder joints on all pads.
- Excessive solder or contacts to neighboring pads, or vias.

REWORK

The module can be unsoldered from the host board if the Moisture Sensitivity Level (MSL) requirements are met as described in this datasheet.

Never attempt a rework on the module itself, e.g. replacing individual components. Such actions will terminate warranty coverage.

SHIPPING, HANDLING, AND STORAGE

Shipping

Bulk orders of the SiFLEX02 modules are delivered in trays of 25.

Handling

The SiFLEX02 modules contain a highly sensitive electronic circuitry. Handling without proper ESD protection may damage the module permanently.

Moisture Sensitivity Level (MSL)

Per J-STD-020, devices rated as MSL 4 and not stored in a sealed bag with desiccant pack should be baked prior to use.

After opening packaging, devices that will be subjected to reflow must be mounted within 72 hours of factory conditions (<30°C and 60% RH) or stored at <10% RH.

Bake devices for 48 hours at 125°C.

Storage

Please use this product within 6 months after receipt. Any product used after 6 months of receipt needs to have solderability confirmed before use.

The product shall be stored without opening the packing under the ambient temperature from 5 to 35deg.C and humidity from 20 to 70%RH. (Packing materials, in particular, may be deformed at the temperatures above this range.)

Do not store in salty air or in an environment with a high concentration of corrosive gas, such as Cl₂, H₂S, NH₃, SO₂, or NO_x.

Do not store in direct sunlight.

The product should not be subject to excessive mechanical shock.

Repeating Reflow Soldering

Only a single reflow soldering process is encouraged for host boards.

AGENCY STATEMENTS

Federal Communication Commission Interference Statement

This equipment has been tested and found to comply with the limits for a Class B digital device, pursuant to Part 15 of the FCC Rules. These limits are designed to provide reasonable protection against harmful interference in a residential installation. This equipment generates uses and can radiate radio frequency energy and, if not installed and used in accordance with the instructions, may cause harmful interference to radio communications. However, there is no guarantee that interference will not occur in a particular installation. If this equipment does cause harmful interference to radio or television reception, which can be determined by turning the equipment off and on, the user is encouraged to try to correct the interference by one of the following measures:

- Reorient or relocate the receiving antenna.
- Increase the separation between the equipment and receiver.
- Connect the equipment into an outlet on a circuit different from that to which the receiver is connected.
- Consult the dealer or an experienced radio/TV technician for help.

This device complies with Part 15 of the FCC Rules. Operation is subject to the following two conditions: (1) This device may not cause harmful interference, and (2) this device must accept any interference received, including interference that may cause undesired operation.

FCC CAUTION: Any changes or modifications not expressly approved by the party responsible for compliance could void the user's authority to operate this equipment.

Industry Canada Statements

Operation is subject to the following two conditions: (1) this device may not cause interference, and (2) this device must accept any interference, including interference that may cause undesired operation of the device.

To reduce potential radio interference to other users, the antenna type and its gain should be so chosen that the equivalent isotropically radiated power (e.i.r.p.) is not more than that permitted for successful communication.

This device has been designed to operate with the antennas listed below, and having a maximum gain of 2.0 dB. Antennas not included in this list or having a gain greater than 2.0 dB are strictly prohibited for use with this device. The required antenna impedance is 50 ohms.

Wire Monopole – 3.2 inch, 22 AWG solid copper wire, pvc insulated

External Dipole – LS Research 001-0002 900 MHz Dipole Antenna with Reverse Polarity SMA Connector and LS Research 080-0001 U.FL to Reverse Polarity SMA Cable (105mm in length)

External Dipole – Nearson S467AH-915, RP-SMA on 6" cable

On Board Chip Helical – Pulse Engineering W3112A

OEM Responsibilities to comply with FCC and Industry Canada Regulations

The SiFLEX02 Module has been certified for integration into products only by OEM integrators under the following conditions:

This device is granted for use in Mobile only configurations in which the antennas used for this transmitter must be installed to provide a separation distance of at least 20cm from all person and not be co-located with any other transmitters except in accordance with FCC and Industry Canada multi-transmitter product procedures.

As long as the two conditions above are met, further transmitter testing will not be required. However, the OEM integrator is still responsible for testing their end-product for any additional compliance requirements required with this module installed (for example, digital device emissions, PC peripheral requirements, etc.).

IMPORTANT NOTE: In the event that these conditions cannot be met (for certain configurations or co-location with another transmitter), then the FCC and Industry Canada authorizations are no longer considered valid and the FCC ID and IC Certification Number cannot be used on the final product. In these circumstances, the OEM integrator will be responsible for re-evaluating the end product (including the transmitter) and obtaining a separate FCC and Industry Canada authorization.

End Product Labelling

The SiFLEX02 Module is labeled with its own FCC ID and IC Certification Number. If the FCC ID and IC Certification Number are not visible when the module is installed inside another device, then the outside of the device into which the module is installed must also display a label referring to the enclosed module. In that case, the final end product must be labeled in a visible area with the following:

“Contains Transmitter Module FCC ID: TFB-SIFLEX2”

“Contains Transmitter Module IC: 5969A-SIFLEX2”

or

“Contains FCC ID: TFB-SIFLEX2”

“Contains IC: 5969A-SIFLEX2”

The OEM of the SiFLEX02 Module must only use the approved antenna(s) listed above, which have been certified with this module.

The OEM integrator has to be aware not to provide information to the end user regarding how to install or remove this RF module or change RF related parameters in the user manual of the end product.

The user manual for the end product must include the following information in a prominent location:

This device is granted for use in Mobile only configurations in which the antennas used for this transmitter must be installed to provide a separation distance of at least 20cm from all person and not be co-located with any other transmitters except in accordance with FCC and Industry Canada multi-transmitter product procedures.

ANTENNA INFORMATION

Wire Antenna (Perpendicular to Board as in Figure 16)

Unit Flat - 914 MHz

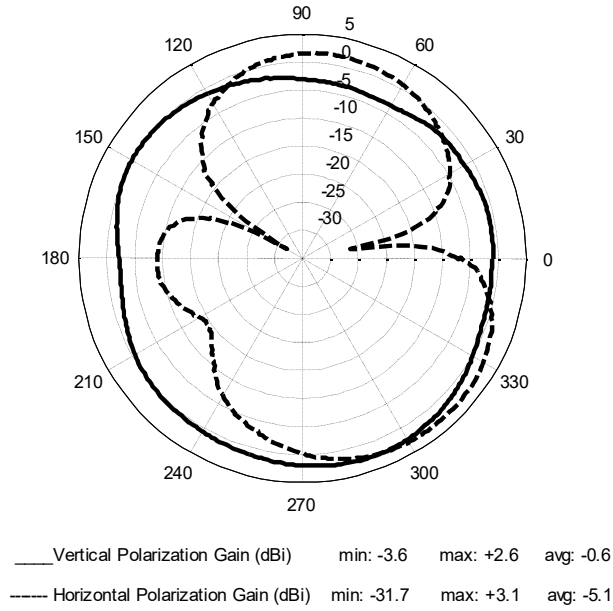

Unit Vertical - 914 MHz

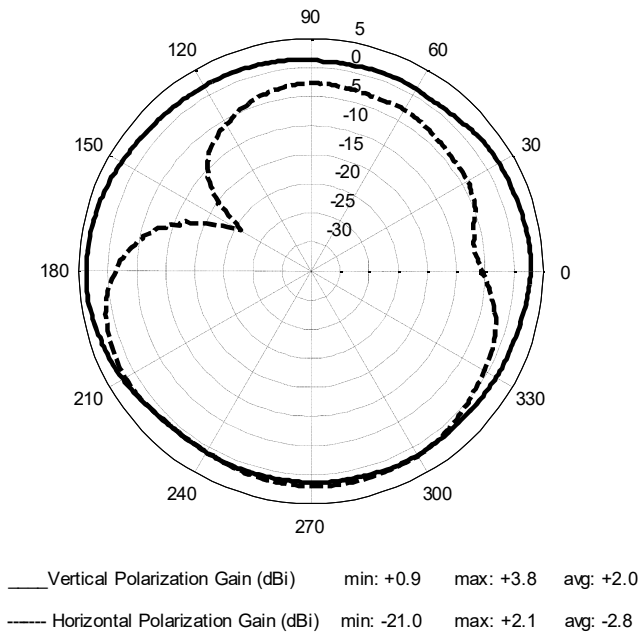

The information in this document is subject to change without notice.

Helical Antenna

Unit Flat - 914 MHz

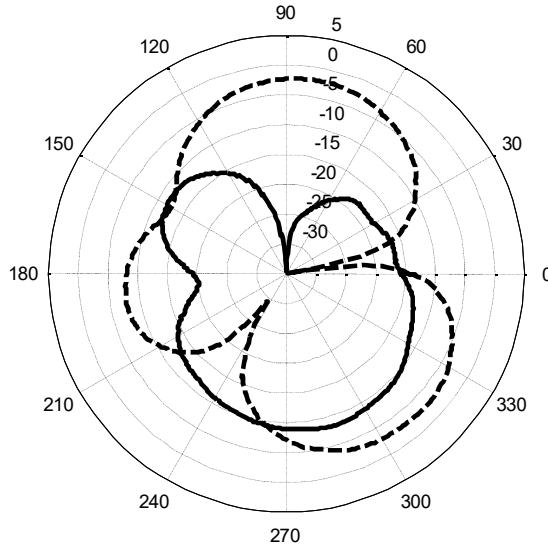

— Vertical Polarization Gain (dBi) min: -34.6 max: -8.2 avg: -15.3
 - - - Horizontal Polarization Gain (dBi) min: -34.8 max: -2.2 avg: -9.2

Unit Vertical - 914 MHz

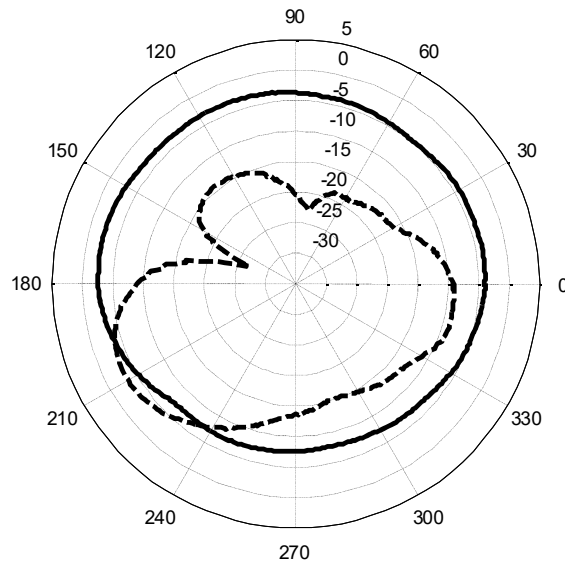

— Vertical Polarization Gain (dBi) min: -7.8 max: -2.4 avg: -4.8
 - - - Horizontal Polarization Gain (dBi) min: -26.8 max: -3.3 avg: -12.9

The information in this document is subject to change without notice.

MECHANICAL DATA

PCB Footprint

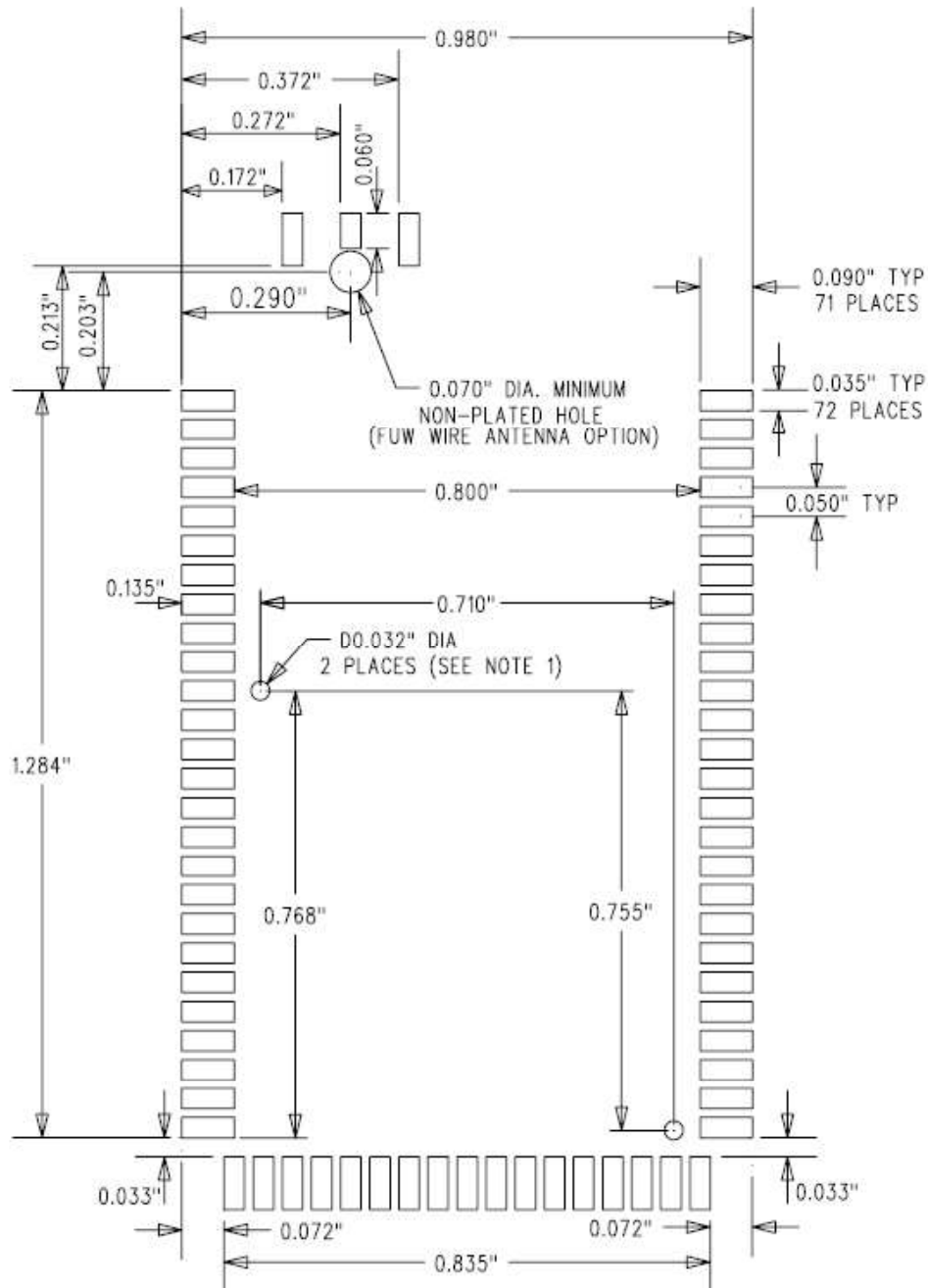

Notes:

- 1) Optional alignment holes are for use with fixture placement and hand soldering operations.
- 2) See <http://wiki.lsr.com> for additional information.

Figure 14 PCB Footprint

The information in this document is subject to change without notice.

General Module Dimensions

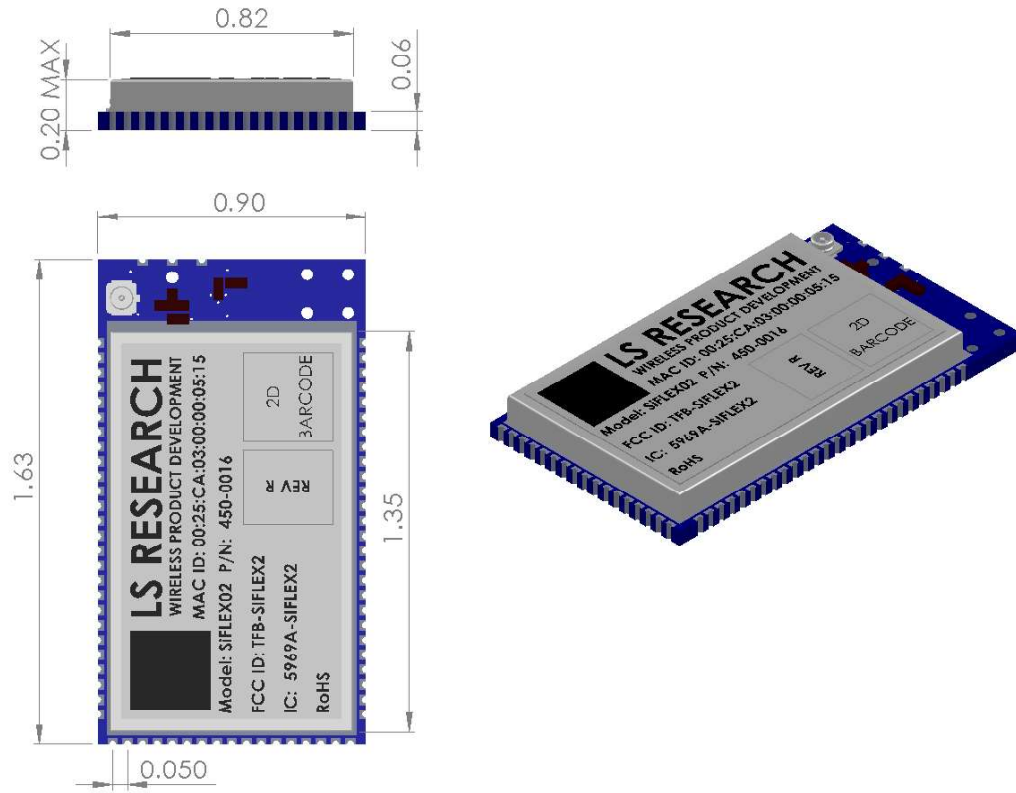

Figure 15 Basic dimensions

Module with Wire Antenna

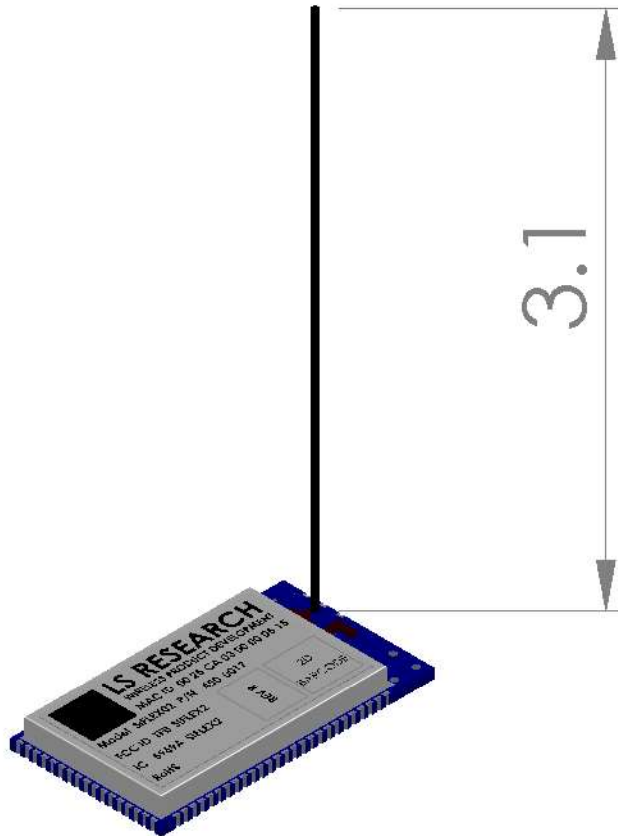

Figure 16 SiFLEX02 with wire antenna

Module with Helical Antenna

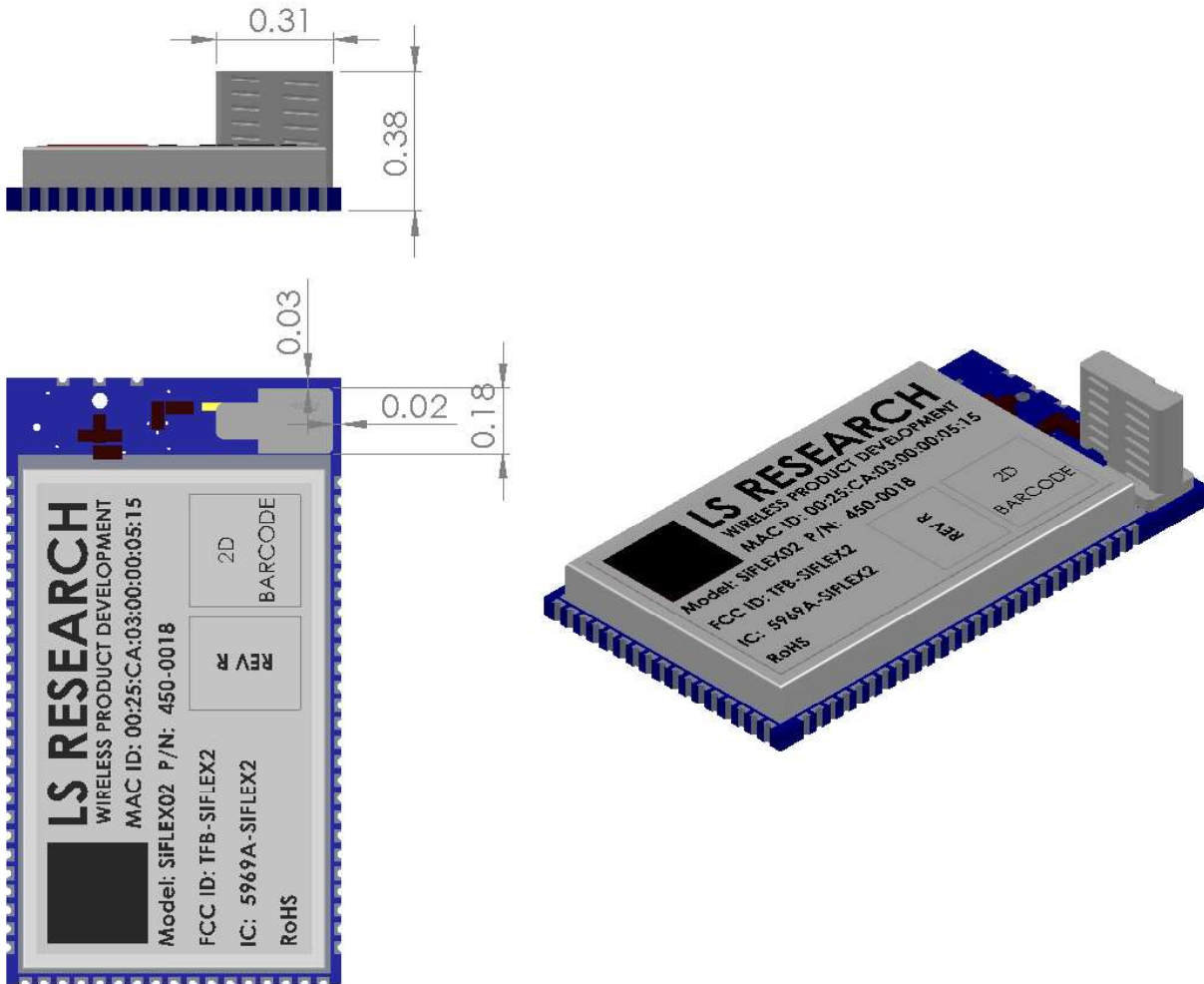

Figure 17 SiFLEX02 with helical antenna

COMPATIBILITY

To maintain compatibility with other ModFLEX™ family transceiver modules it is important to use the module pins in your application as they are designated in Figure 18. Since the available GPIO and peripherals vary per micro, not all pins may be populated. For example on SiFLEX02 module pins 45-55 are not available (due to the number of GPIO available on the ATxMega256A3).

All attempts are made to lay out modules starting with the lowest number in the peripheral (ADC, TMR/PWM, GPIO) series. For example if there are only two ADC's available they will be brought out to ADC1 and ADC2 (module pins 20 and 21).

ModFLEX™ Generic Module Footprint																												
GND	1																									69	GND	
GND	2																										68	GND
GND	3																										67	GND
NC	4																										66	NC
NC	5																										65	NC
NC	6																										64	NC
NC	7																										63	NC
NC	8																										62	NC
JTAG - TMS	9																										61	SPI - MOSI
JTAG - TDI	10																										60	SPI - MISO
JTAG - TCK	11																										59	SPI - SCK
JTAG - TDO	12																										58	SPI - SS
JTAG/PDI/JRST	13																										57	IIC - SDA
nReset	14																										56	IIC - SCL
Analog REF	15																										55	GPIO 16
Analog REF	16																										54	GPIO 15
CMP+	17																										53	GPIO 14
CMP-	18																										52	GPIO 13
CMPOUT	19																										51	GPIO 12
ADC1	20																										50	GPIO 11
ADC2	21																										49	GPIO 10
ADC3	22																										48	GPIO 9
ADC4	23																										47	GPIO 8
ADC5	24																										46	GPIO 7
ADC6	25																										45	GPIO 6
VCC - 3V3DC	26																										44	GND
		27	28	29	30	31	32	33	34	35	36	37	38	39	40	41	42	43										
		TMR/PWM 1	TMR/PWM 2	TMR/PWM 3	TMR/PWM 4	TMR/PWM 5	TMR/PWM 6	TMR/PWM 7	TMR/PWM 8	UART - TX	UART - RX	UART - CTS	UART - RTS	GPIO 1	GPIO 2	GPIO 3	GPIO 4	GPIO 5										

Figure 18 ModFLEX™ Generic Module Footprint

MODULE REVISION HISTORY

Rev 1.0

- Initial Release

U.FL and wire antenna modules



00:25:CA:03:00:00:XX:XX = MAC ID
1D Barcode Format is Code 128 Standard
XX:XX = unique portion of MAC ID that
changes for each module
PCB is green in color

Rev 1.1

- Changed color of PCB from green to blue.
- Printed explicit MAC ID on module.
- FCC and IC numbers changed.
- Model number changed.

All antenna models



00:25:CA:03:XX:XX:XX = MAC ID
1D Barcode Format is Code 128 Standard
XX:XX:XX:XX = unique portion of MAC ID that
changes for each module

Rev 1.3

- Changed from 1D barcode to 2D barcode.
- Added revision on label.
- Made model number generic and added part number for each module type.

Part Number: 450-0016
U.FL Module



00:25:CA:03:XX:XX:XX = MAC ID
2D Barcode Format is Data Matrix Standard
XX:XX:XX:XX = unique portion of MAC ID that changes for each module

Part Number: 450-0017
Wire Module



00:25:CA:03:XX:XX:XX = MAC ID
2D Barcode Format is Data Matrix Standard
XX:XX:XX:XX = unique portion of MAC ID that changes for each module

Part Number: 450-0018
Helical Module



00:25:CA:03:XX:XX:XX = MAC ID
2D Barcode Format is Data Matrix Standard
XX:XX:XX:XX = unique portion of MAC ID that changes for each module

Part Number: 450-0019
RF Castellation Module



00:25:CA:03:XX:XX:XX = MAC ID
2D Barcode Format is Data Matrix Standard
XX:XX:XX:XX = unique portion of MAC ID that changes for each module

Rev 2.0

- LSR logo changed from red to black.
- Revision format changed from “REV X.Y” to “REV X”.
- Included firmware release version 3.0.

Part Number: 450-0016
U.FL Module



00:25:CA:03:XX:XX:XX = MAC ID
2D Barcode Format is Data Matrix Standard
XX:XX:XX:XX = unique portion of MAC ID that changes for each module

Part Number: 450-0017
Wire Module



00:25:CA:03:XX:XX:XX = MAC ID
2D Barcode Format is Data Matrix Standard
XX:XX:XX:XX = unique portion of MAC ID that changes for each module

Part Number: 450-0018
Helical Module



00:25:CA:03:XX:XX:XX = MAC ID
2D Barcode Format is Data Matrix Standard
XX:XX:XX:XX = unique portion of MAC ID that changes for each module

Part Number: 450-0019
RF Castellation Module



00:25:CA:03:XX:XX:XX = MAC ID
2D Barcode Format is Data Matrix Standard
XX:XX:XX:XX = unique portion of MAC ID that changes for each module

Rev 3.0

- Changed wire antenna.

Part Number: 450-0017

Wire Module



00:25:CA:03:XX:XX:XX = MAC ID

2D Barcode Format is Data Matrix Standard

XX:XX:XX:XX = unique portion of MAC ID that
changes for each module

CONTACTING LS RESEARCH

Headquarters	LS Research, LLC W66 N220 Commerce Court Cedarburg, WI 53012-2636 USA Tel: 1(262) 375-4400 Fax: 1(262) 375-4248
Website	www.lsr.com
Wiki	wiki.lsr.com
Technical Support	forum.lsr.com
Sales Contact	sales@lsr.com

The information in this document is provided in connection with LS Research (hereafter referred to as “LSR”) products. No license, express or implied, by estoppel or otherwise, to any intellectual property right is granted by this document or in connection with the sale of LSR products. EXCEPT AS SET FORTH IN LSR’S TERMS AND CONDITIONS OF SALE LOCATED ON LSR’S WEB SITE, LSR ASSUMES NO LIABILITY WHATSOEVER AND DISCLAIMS ANY EXPRESS, IMPLIED OR STATUTORY WARRANTY RELATING TO ITS PRODUCTS INCLUDING, BUT NOT LIMITED TO, THE IMPLIED WARRANTY OF MERCHANTABILITY, FITNESS FOR A PARTICULAR PURPOSE, OR NON-INFRINGEMENT. IN NO EVENT SHALL LSR BE LIABLE FOR ANY DIRECT, INDIRECT, CONSEQUENTIAL, PUNITIVE, SPECIAL OR INCIDENTAL DAMAGES (INCLUDING, WITHOUT LIMITATION, DAMAGES FOR LOSS OF PROFITS, BUSINESS INTERRUPTION, OR LOSS OF INFORMATION) ARISING OUT OF THE USE OR INABILITY TO USE THIS DOCUMENT, EVEN IF LSR HAS BEEN ADVISED OF THE POSSIBILITY OF SUCH DAMAGES. LSR makes no representations or warranties with respect to the accuracy or completeness of the contents of this document and reserves the right to make changes to specifications and product descriptions at any time without notice. LSR does not make any commitment to update the information contained herein. Unless specifically provided otherwise, LSR products are not suitable for, and shall not be used in, automotive applications. LSR’s products are not intended, authorized, or warranted for use as components in applications intended to support or sustain life.

The information in this document is subject to change without notice.