

PLL2091EWIP - 60° FWHM

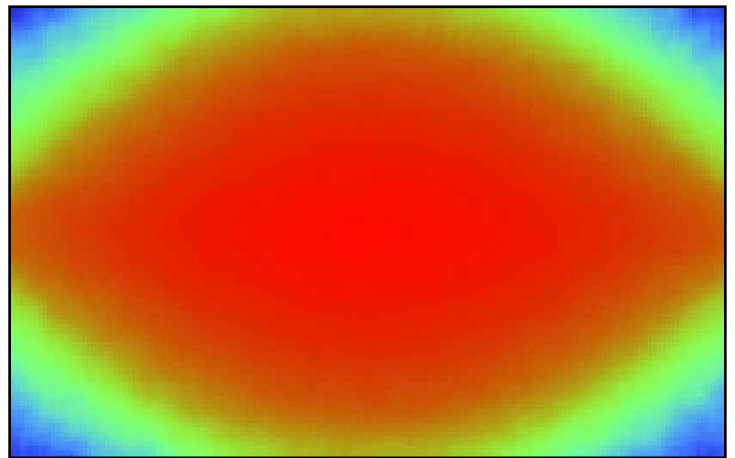

- Material = PMMA Clear - **Non-yellowing, 10-year guarantee****
- Full angle C0-C180 at 50% from maximum: ~ 54°x100°
- The light spots here represented refer to tests carried out with 22 1/2 Watt LEDs, 5.6x3mm size, ~ 1100lm@Strip

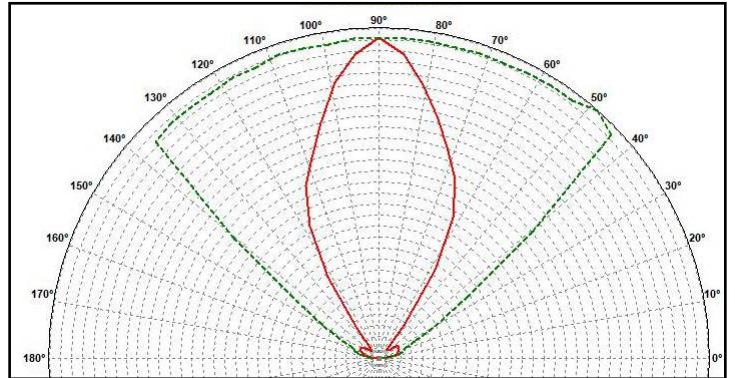
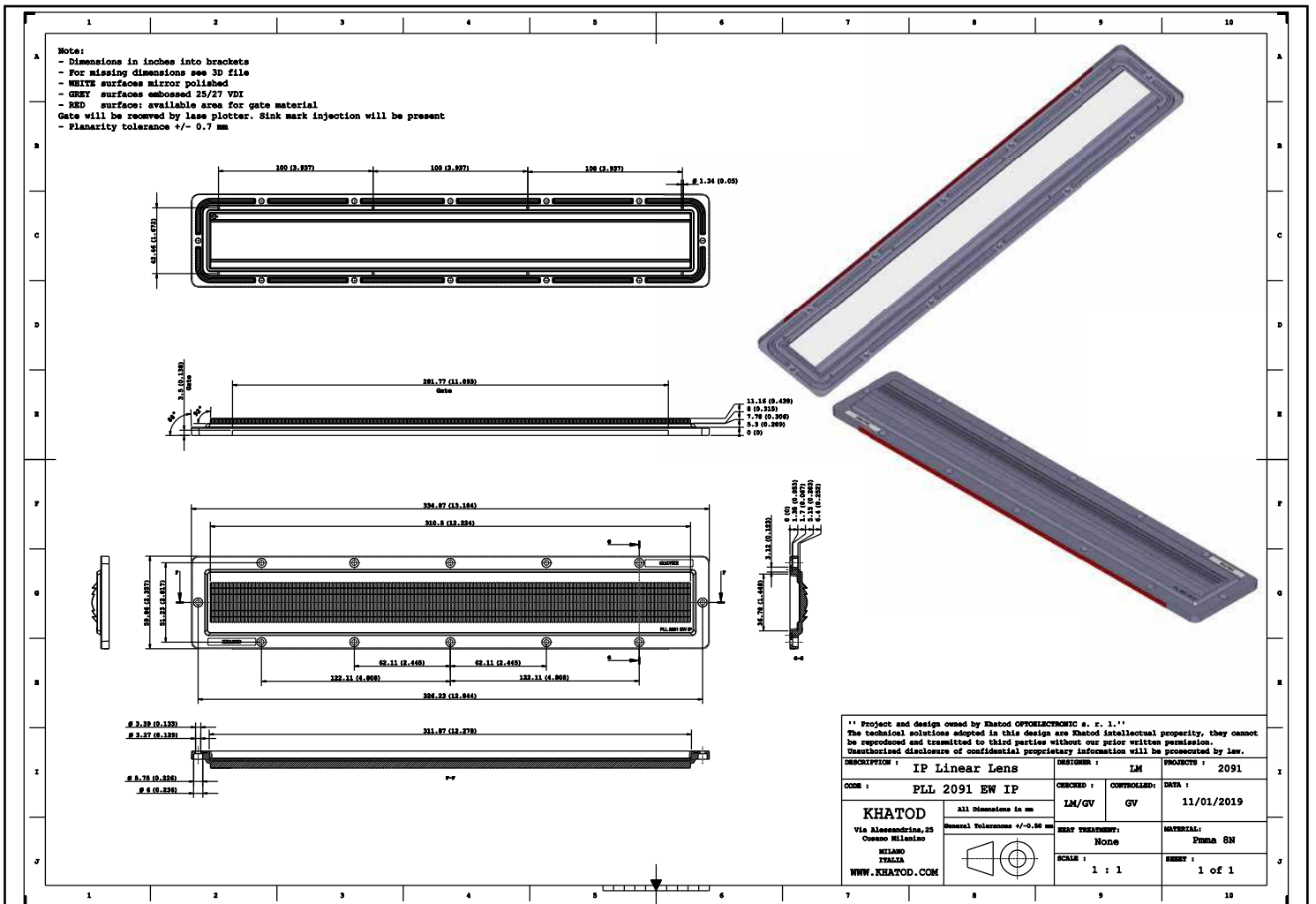

KGAS2091 - Gasket for PLL2091xxIP, made of silicone

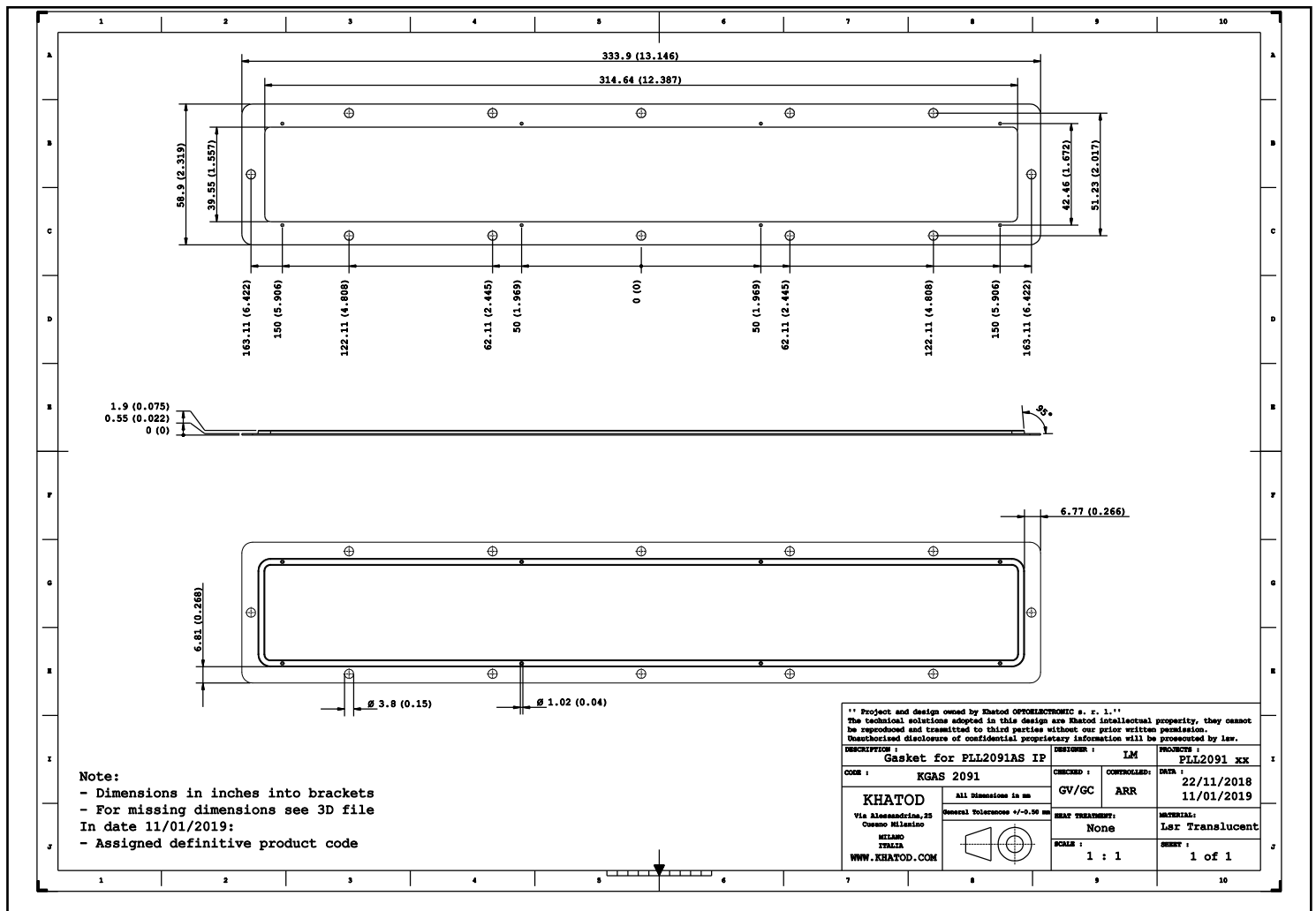

KGAS2091 - Physical Characteristics

Hardness sh A : 65 +/-5	Color : Transparent	Abbrev. : SIL 65H TRASP
Basic Element : VMQ	Vulcanization: 10min @ 150°C	Annealing : 4 hours@200°C

Original Parameters	Unit of Measurement	Detected Values	Test Method
Hardness	Shore A	65	ASTM D 2240
Hardness	IRHD		
100% Modulus	MPa		ASTM D 412
100% Modulus	N/mm ²		

Tensile Strength	MPa	9	ASTM D 412
Elongation	%	620	ASTM D 412
Tear resistance	N/mm	30	ASTM D 624/B
Specific Gravity	g/cm ³	1.16	ASTM D 297
Brittleness Point	°C		
TR-TEST TR10	°C		ASTM D 1329
TR TEST TR-30	°C		
Compression Set 25% Temperature: 175°C @ 22h	%	27	ASTM D 395/B

Assembly Specifications

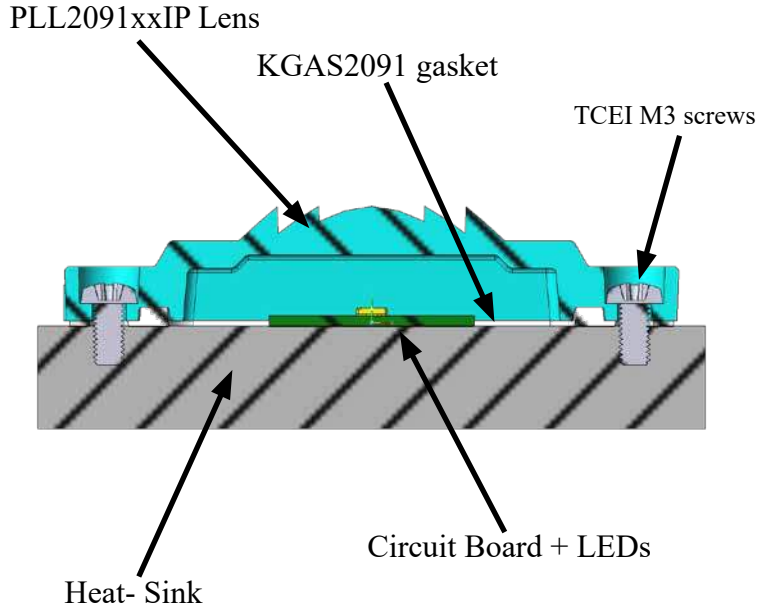

Use TCEI M3 screws

- M3: Maximum tightening torque ~ 0.4 Nm

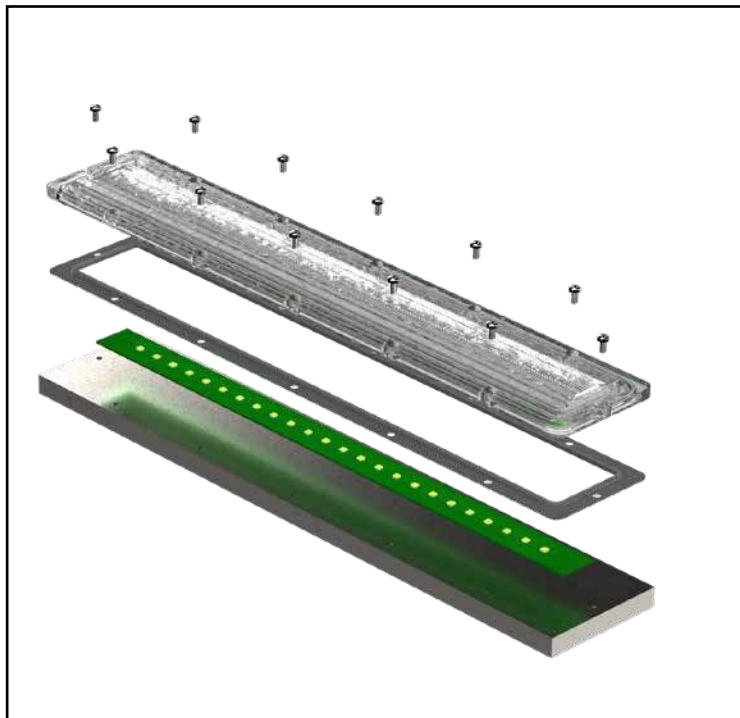

IP X5 Test

Note

The present document is an internal document showing the tests carried out by Khatod in its laboratory. The tests, photos and videos presented in this document are made available for demonstration purposes only. Khatod, with its laboratory, is not a certification body.

If customers need IP accredited certifications, they have to apply to the appointed Certification Bodies, under their sole care and responsibility.

Data and Analysis

The sample has been subjected to the water-penetration resistance test as follows:

- Assembly of the components to test :
A moisture indicator paper sheet has been interposed between the lens and the clamping base
- Positioning of the assembled sample under the device of watering with nozzle Ø 6.3 millimeters
- Water flow: 12.5 l/min \pm 5%
- Water pressure: 30 kPa @ distance of 3m
- Duration of water spraying test on the wrap surface per m² : 1 min
- Minimum duration of the test: 3 min
- Distance between the nozzle and the wrap surface: 2.5 Meters



IP Testing



Testing under water jet

Conclusion



The test paper sheet is dry

As shown in the photo, the test paper sheet is completely dry after disassembling the system.

The product has passed the Khatod test.

Packaging

Item	Quantity	Total Parts	Size (L*W*H)	G.W.
Multi-pocket plastic bag	20 pieces per multi-pocket plastic bag	20 pcs	110*40 cm	0.8 Kg
Outer Box	15 multi-pocket plastic bags per Outer Box	300 pcs	50*32*38 cm	12.5 Kg



300 Lenses / Multi-pocket plastic bags

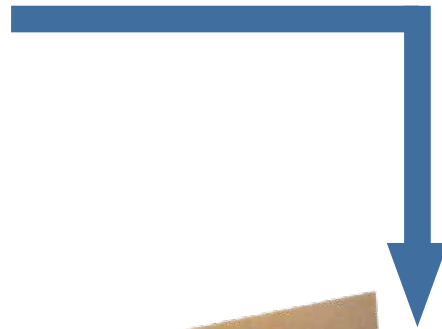

15 Multi-pocket plastic bags per Outer Box

Materials

Material	Top
PMMA 8N **	-40°...80°C
For further information please visit Evonik website	

**

PLL2091xxIP Series is made of the same material used to produce PLEXIGLAS® Solar which guarantees it will show no yellowing for 10 years.

Yellowness Index (YI) according to the test standards for Arizona/Florida outdoor exposure testing:

- YI 6 under hot/dry conditions
- YI 8 under hot/wet conditions

Notes:

- Intensity (I) and illuminance (E) data are normalized by 1000 lm
- The optical values shown are the result of optical simulations carried out with LIGHTTOOLS, ASAP and ZEMAX software systems. The optical simulations are carried out on the basis of the typical values provided in the LED manufacturers' official datasheets. The photometric analysis has been carried out on physical samples. On request, by supplying your PCB, we can provide the measurement photometric file.

Use and Maintenance

- DO NOT HANDLE OR INSTALL LENSES WITHOUT WEARING GLOVES, SKIN OILS MAY DAMAGE LENS OR LIGHT TRANSMISSION;
- CLEAN LENSES WITH MILD SOAP AND WATER AND A SOFT CLOTH;
- DO NOT USE ANY COMMERCIAL CLEANING SOLVENTS ON LENSES.

Disclaimer

Please note that flow lines and weld lines on the external surfaces of the lenses are acceptable if the optical performance of the lens is within the specifications.

Should you require further information, please contact Khatod for advice. All lens testing must be subject to identical conditions as Khatod test condition. Khatod Optoelectronic, Milan, Italy, manufactures lenses for LEDs. Any other use of the lens shall void our liability and warranty. The lenses are an inert component to be used in the manufacture of various products. Our warranty and liability are limited only to the manufacture of the lens. You may not modify, copy, distribute reproduce, license or alter the lens and related materials of Khatod. Khatod does not warrant against damages or defects arising out of the use or misuse of the products; against defects or damage arising from improper installation, or against defects in the product or in its components. No warranty of any kind, expressed or implied, is made regarding the safety of the products. The entire risk as to the quality or performance of the product is with the buyer. In no event shall Khatod be liable for any direct, indirect, punitive, incidental, special, consequential damages, or any damages whatsoever arising out of or connected with the use or misuse of the product. Khatod shall not have any obligation with respect to the product or any part thereof, whether based on contract, tort, strict liability or otherwise. Buyer assumes all risks and liability from use of the product. The laws of Milan, Italy govern this product warranty and liability and you hereby consent to the exclusive jurisdiction and venue of courts in Milan, Italy in all disputes arising out of or relating to the use of this product. Production, marketing, distribution, sale of these products as well as their possible modifications and variations are only exclusive right of Khatod Optoelectronic. No company can perform any of these actions without written permission released by Khatod Optoelectronic. The information contained in this document is proprietary of Khatod Optoelectronic and may change without notice.

REPRODUCTION PROHIBITED.