

THIS DRAWING IS UNPUBLISHED.

RELEASED FOR PUBLICATION

ALL RIGHTS RESERVED.

© COPYRIGHT - TE Connectivity Ltd.

REVISIONS

P	LTR	DESCRIPTION	DATE	DWN	APVD
B		REVISED PER ECR-19-004770	10APR2019	SR	DD

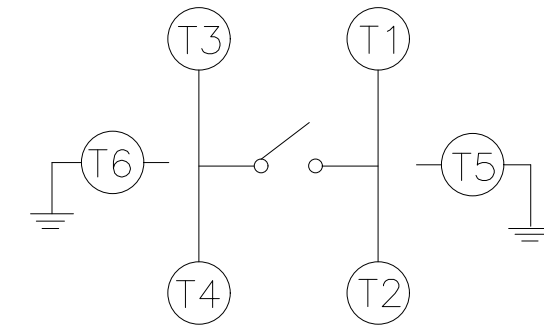
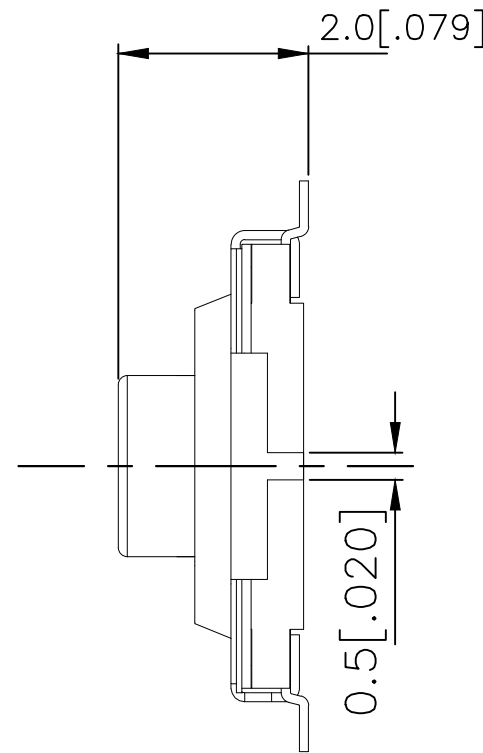
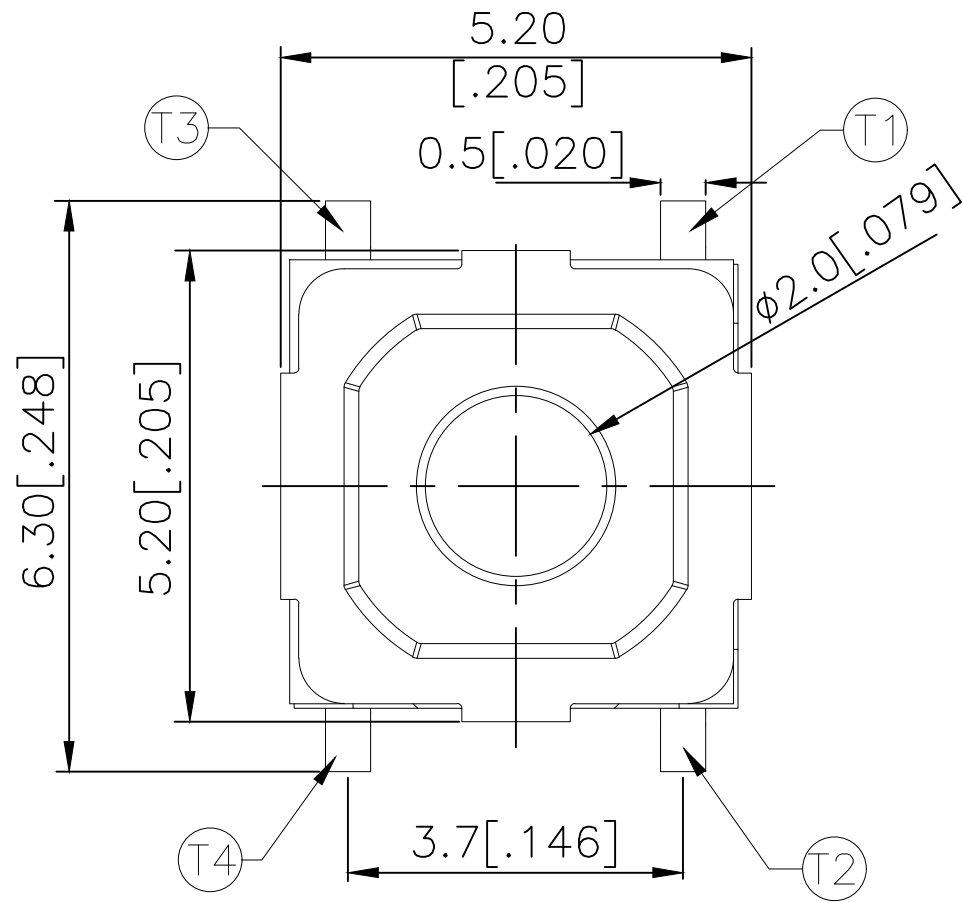

CIRCUIT DIAGRAM

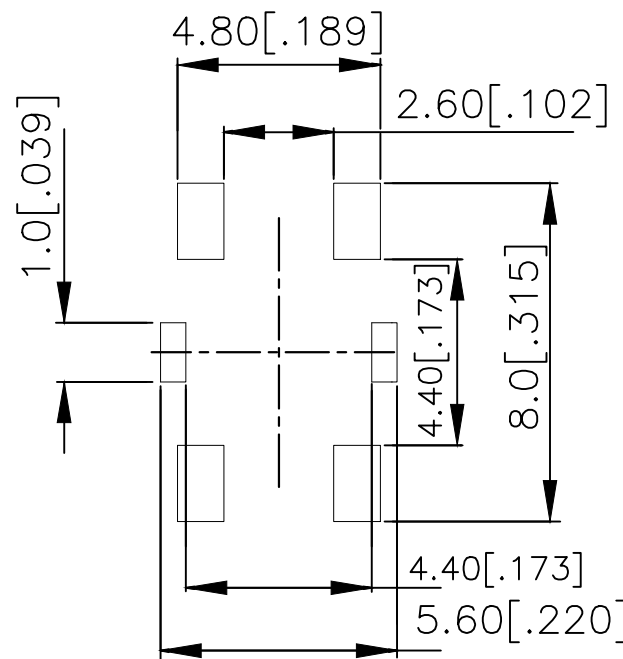
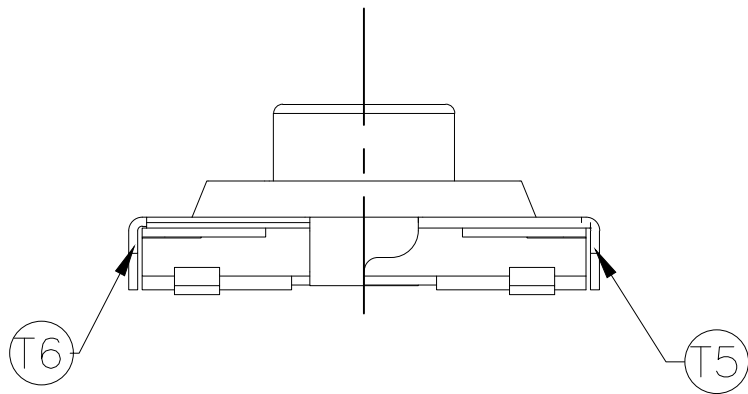

P.C.B LAYOUT

WHITE	260±50	MSLPT5252CG4WTR	2337238-4
BLACK	160±50	MSLPT5252CG3BTR	2337238-3
WHITE	100±50	MSLPT5252CG2WTR	2337238-2
BLACK	70±50	MSLPT5252CG1BTR	2337238-1
ACTUATOR COLOR	ACTUATION FORCE (gf)	SMART PART NUMBER	PART NUMBER

THIS DRAWING IS A CONTROLLED DOCUMENT.

DWN 04JUL2018

GANESH C M

CHK 04JUL2018

ALEXANDER SHARPE

APVD 04JUL2018

ALEXANDER SHARPE

PRODUCT SPEC

APPLICATION SPEC

WEIGHT

NAME

SWITCH, TACTILE, LOW-PROFILE, MINI,
5.2 x 5.2 x 2.0, GULLWING

SIZE

CAGE CODE

DRAWING NO

RESTRICTED TO

A3 00779 C-2337238

CUSTOMER DRAWING

SCALE NTS

SHEET 1 of 3

REV B

DIMENSIONS:
mm [INCHES]

TOLERANCES UNLESS OTHERWISE SPECIFIED:

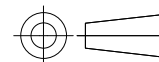

0 PLC	± -
1 PLC	± -
2 PLC	± 0.2 [.008]
3 PLC	± -
4 PLC	± -
ANGLES	± -
FINISH	-

MATERIAL

FINISH

THIS DRAWING IS UNPUBLISHED.

RELEASED FOR PUBLICATION

© COPYRIGHT - TE Connectivity Ltd.

ALL RIGHTS RESERVED.

REVISIONS

P	LTR	DESCRIPTION	DATE	DWN	APVD
-	-	SEE SHEET 1	-	-	-

NOTES:

1. MATERIALS:

TERMINAL: COPPER ALLOY, SILVER OVER NICKEL FINISH
 BASE: THERMOPLASTIC, BLACK
 ACTUATOR: THERMOPLASTIC, SEE TABLE, SHEET 1 OF 3, FOR COLOR
 TAPE: POLYTETRAFLUOROETHYLENE
 CONTACT: STAINLESS STEEL, SILVER OVER NICKEL FINISH
 COVER: NICKEL SILVER

2. COMPLIANCE:

ALL MATERIALS AND FINISHES SHALL COMPLY WITH EU DIRECTIVE 2002/95/EC OF 27JAN2003(RoHS)

3. SPECIFICATIONS:

RATING: 50 mA, 12V DC
 CONTACT RESISTANCE: 100mΩ MAXIMUM (INITIAL)
 INSULATION RESISTANCE: 100MΩ MINIMUM (INITIAL)
 DIELECTRIC STRENGTH: 250V AC, 1 MINUTE
 OPERATING LIFE: 2337238-1 (70gf) = 1,000,000 CYCLES WITH LOAD
 2337238-2 (100gf) = 1,000,000 CYCLES WITH LOAD
 2337238-3 (160gf) = 1,000,000 CYCLES WITH LOAD
 2337238-4 (260gf) = 200,000 CYCLES WITH LOAD

TRAVEL: 0.25±0.1 [0.010±0.004]

ACTUATION FORCE: 2337238-1 = 70±50gf
 2337238-2 = 100±50gf
 2337238-3 = 160±50gf
 2337238-4 = 260±50gf

OPERATING TEMPERATURE: -25° TO 70°C
 STORAGE TEMPERATURE: -30° TO 80°C

4. SOLDER CONDITIONS :

SMT:

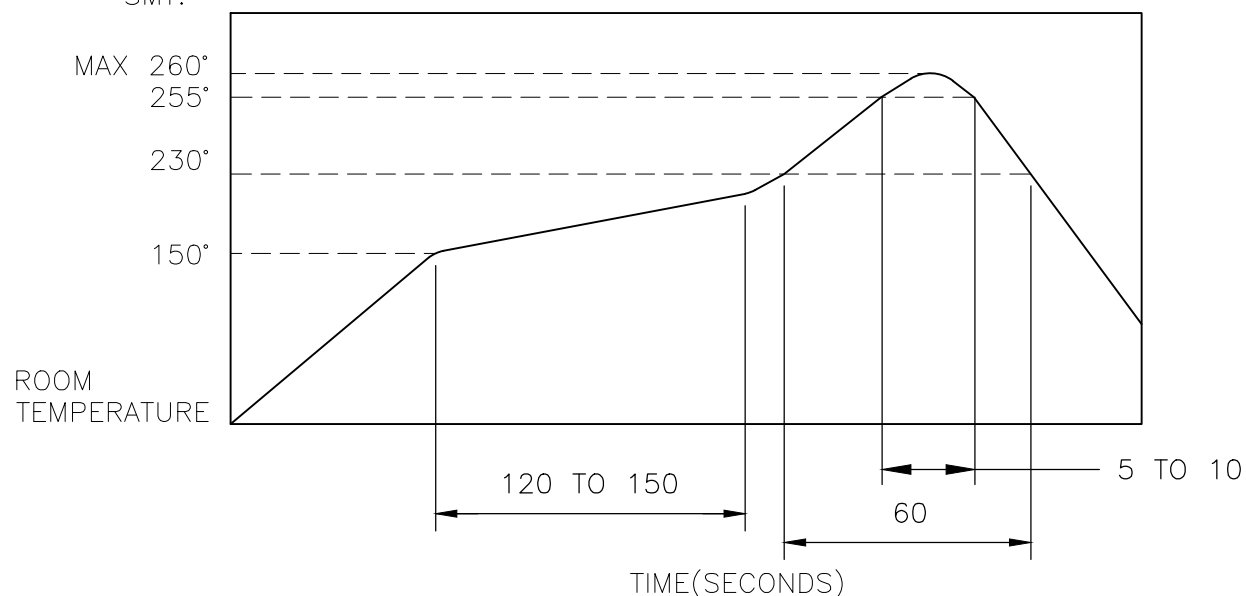

THE CONDITON NOTED ABOVE IS THE TEMPERATURE OF THE COPPER FOIL ON THE SURFACE OF THE PCB. THERE ARE CASES WHERE THE TEMPERATURE OF THE BOARD GREATLY DIFFERS FROM THE SURFACE OF THE SWITCH. DO NOT ALLOW THE SURFACE TEMPERATURE OF THE SWITCH TO EXCEED 260°C.

MANUAL SOLDERING:

SOLDERING TEMPERATURE	350°C MAXIMUM
CONTINUOUS SOLDERING TIME	5 SECONDS MAXIMUM

HANDLING PRECAUTIONS:

- CARE SHOULD BE EXERCISED SO THAT FLUX FROM THE TOP SURFACE OF THE PRINTED CIRCUIT BOARD DOES NOT ADHERE TO THE SWITCH.
- DO NOT WASH THE SWITCH

5. OPERATING PRECAUTIONS:

- DO NOT ACTUATE THE SWITCH WITH EXCESSIVE FORCE
- DISCONTINUE FORCE AFTER THE SWITCH HAS BEEN ACTUATED SO AS TO AVOID DEFORMATION OF THE COMPONENTS OF THE SWITCH. DEFORMATION OF THE COMPONENTS MAY CAUSE THE SWITCH TO MALFUNCTION.
- ALIGN THE PLUNGER WITH THE SWITCH TO INSURE PROPER OPERATION

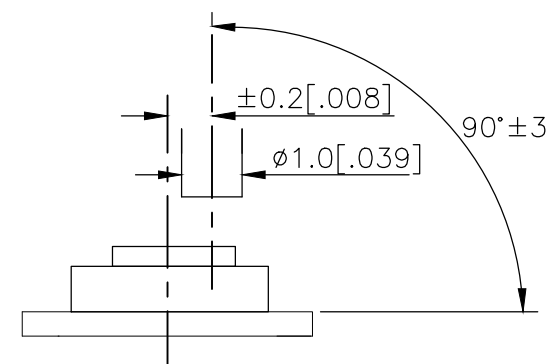

THIS DRAWING IS A CONTROLLED DOCUMENT.		DWN GANESH C M 04JUL2018	TE Connectivity Ltd.		
DIMENSIONS: mm [INCHES]		CHK ALEXANDER SHARPE 04JUL2018			
TOLERANCES UNLESS OTHERWISE SPECIFIED:		APVD ALEXANDER SHARPE 04JUL2018	SIZE A3 CAGE CODE 00779 DRAWING NO C-2337238 RESTRICTED TO -		
0 PLC ± - 1 PLC ± - 2 PLC ± 0.2 [0.008] 3 PLC ± - 4 PLC ± - ANGLES ± -		PRODUCT SPEC -			
MATERIAL -		APPLICATION SPEC -	CUSTOMER DRAWING		
FINISH -		WEIGHT -			

THIS DRAWING IS UNPUBLISHED.

RELEASED FOR PUBLICATION

ALL RIGHTS RESERVED.

© COPYRIGHT - TE Connectivity Ltd.

REVISIONS

P	LTR	DESCRIPTION	DATE	DWN	APVD
-	-	SEE SHEET 1	-	-	-

THE DIMENSIONS OF CARRIER TAPE AND REEL:

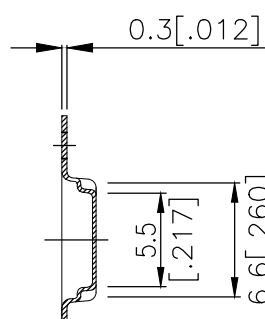
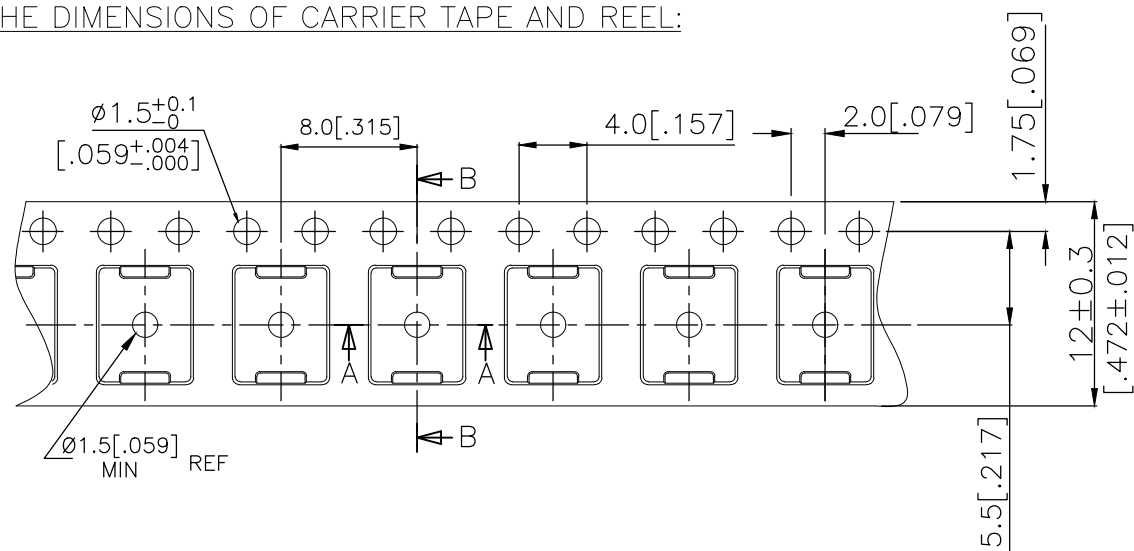

Section B-B

ORIENTAION OF PILOT HOLES

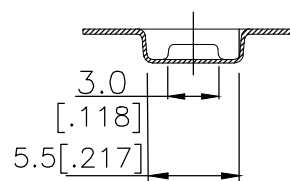
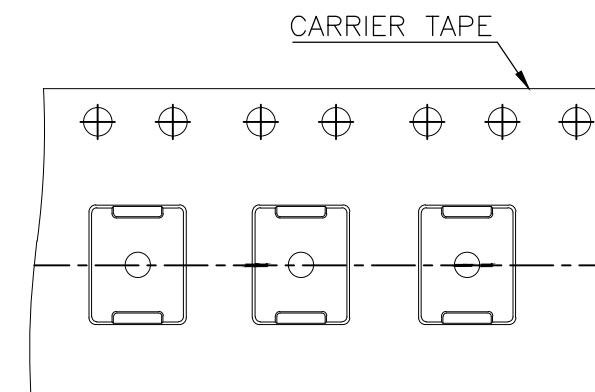

Section A-A

6. PACKAGING:

1. THE TAPE AND REEL ARE SHOWN FOR CUSTOMER APPLICATION REFERENCE. PACKAGING NOTES 3 AND 4 ARE REQUIRED BUT NOT ILLUSTRATED.
2. 3,000 SWITCHES PER REEL.
3. THE REEL, DESICCANT POUCH AND HUMIDITY CARD ARE SEALED IN A MOISTURE BARRIER BAG PER THE CURRENT REVISION OF IPC/JEDEC J-STD-033, MSL 2A REQUIREMENTS.
4. THE MOISTURE BARRIER BAG IS LABELED PER THE CURRENT REVISION OF IPC/JEDEC J-STD-033, MSL 2A REQUIREMENTS.

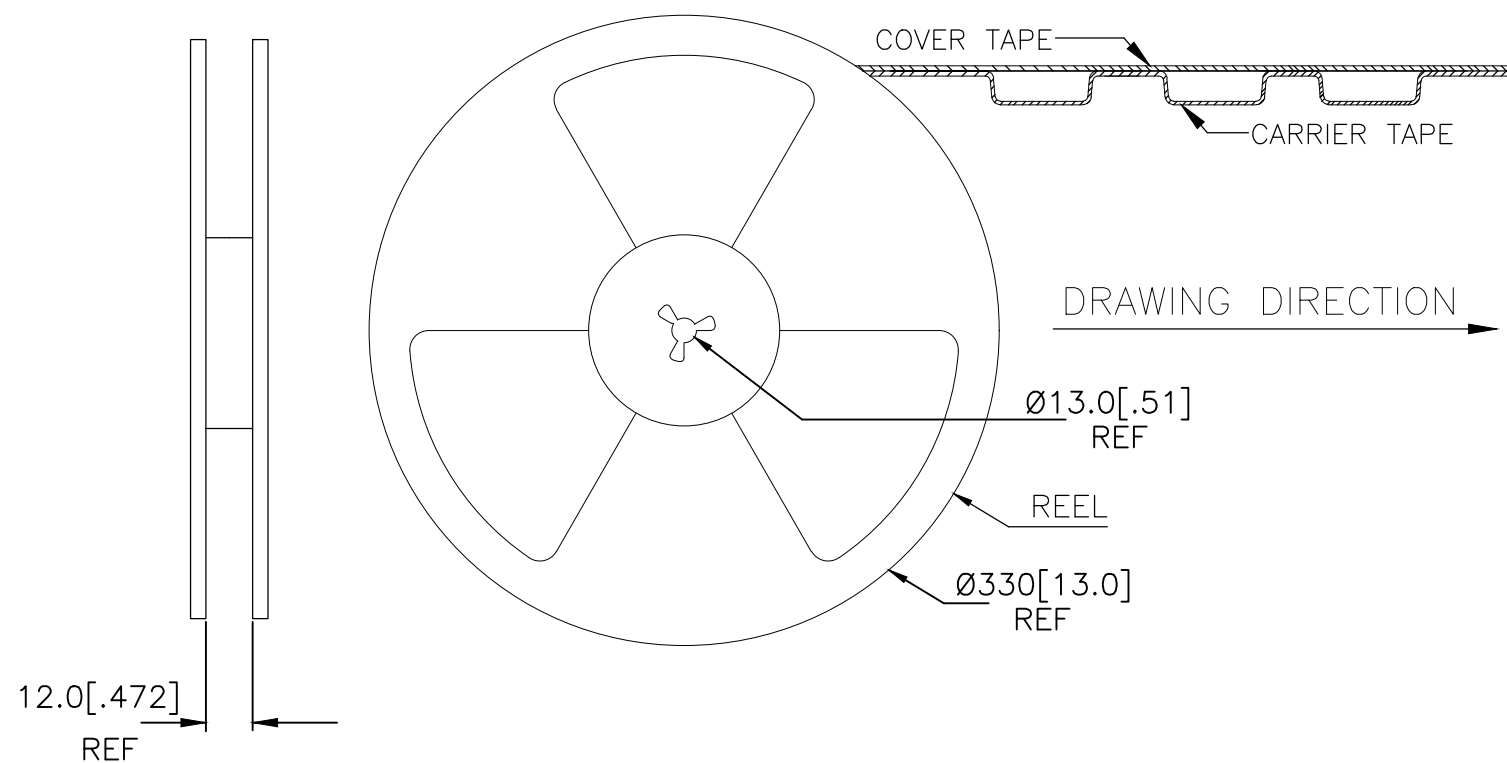

THIS DRAWING IS A CONTROLLED DOCUMENT.		DWN	GANESH C M		04JUL2018		 TE Connectivity Ltd.												
DIMENSIONS: mm [INCHES]		CHK	ALEXANDER SHARPE		03JUL2018														
TOLERANCES UNLESS OTHERWISE SPECIFIED:		APVD	ALEXANDER SHARPE		04JUL2018		NAME												
<table border="0"> <tr><td>0 PLC</td><td>± -</td></tr> <tr><td>1 PLC</td><td>± -</td></tr> <tr><td>2 PLC</td><td>± 0.2 [.008]</td></tr> <tr><td>3 PLC</td><td>± -</td></tr> <tr><td>4 PLC</td><td>± -</td></tr> <tr><td>ANGLES</td><td>± -</td></tr> </table>		0 PLC	± -	1 PLC	± -	2 PLC	± 0.2 [.008]	3 PLC	± -	4 PLC	± -	ANGLES	± -	PRODUCT SPEC		-		SWITCH, TACTILE, LOW-PROFILE, MINI, 5.2 x 5.2 x 2.0, GULLWING	
0 PLC	± -																		
1 PLC	± -																		
2 PLC	± 0.2 [.008]																		
3 PLC	± -																		
4 PLC	± -																		
ANGLES	± -																		
MATERIAL		FINISH		-		APPLICATION SPEC		-											
-		-		-		WEIGHT		-											
CUSTOMER DRAWING				SIZE	CAGE CODE	DRAWING NO	RESTRICTED TO												
-				A3	00779	C-2337238	-												
-				SCALE	NTS	SHEET	3 OF 3	REV											
-				-		-		B											