



TAOGLAS®



Datasheet

Part No:
G30.B.108111

Description

Olympian Direct Mount Ultra Wide-Band
4G/3G/2G
LTE / Cellular / Wi-Fi Antenna
For 2G/3G/4G Applications

Features:

698 to 960MHz, 2.4GHz and 1710 to 2700MHz
Heavy duty screw mount
UV and Features vandal resistant ABS
housing and thread
IP67 compliant
Standard is 1M RG-316 SMA(M)
Cables and Connectors Customizable
CE Certified
RoHS & REACH Compliant

1.	Introduction	2
2.	Specification	3
3.	Antenna Characteristics	5
4.	Radiation Patterns	9
5.	Mechanical Drawing	26
6.	Packaging	27
7.	Installation Guide	28
<hr/>		
	Changelog	30

Taoglas makes no warranties based on the accuracy or completeness of the contents of this document and reserves the right to make changes to specifications and product descriptions at any time without notice Taoglas reserves all rights to this document and the information contained herein Reproduction, use or disclosure to third parties without express permission is strictly prohibited



1. Introduction



The G30 Olympian is a high performance screw mount wide-band cellular antenna for external use on vehicles and outdoor assets worldwide. Omni-directional high gain and high efficiency across all bands ensures constant reception and transmission. This is vital for today's high data bandwidth applications in video and mobile broadband.

Durable UV resistant ABS housing is resistant to vandalism and direct attack. At only 48mm height it complies with the latest EU height restrictions directives for roof-mounted objects. This antenna is mounted on metal and plastic structures and is locked from the inside of the structure by a nut. Adhesive foam at the base provides a watertight seal to the mounting structure. High quality waterproof and corrosion resistant Teflon jacket RG316 is used for the cable.

Two of these G30 separated at distance from each other are ideal for the latest LTE MIMO spatial diversity applications.

Customized cable length and connectors are available. Taoglas recommend a minimum cable length of 70mm when used on a ground plane to achieve an efficiency of greater than 40% in the 900MHz band and greater than 60% in the 1800MHz band. For further information please contact your regional Taoglas customer support team.

2. Specification

LTE Electrical									
Band	Frequency (MHz)	Measurement	Efficiency (%)	Average Gain (dB)	Peak Gain (dBi)	Impedance	Polarization	Radiation Pattern	Max. input power
5GNR/4G Band 5,8,12,13,14,17,18,20,26,27,28,29,71	617-960	Free Space.	46.2	-3.36	3.38	50 Ω	Linear	Omni	2W
		Ground Plane.	47.6	-3.22	4.54				
5GNR/4G Band 21,32,74,75,76	1427-1518	Free Space.	31.9	-4.96	2.90				
		Ground Plane.	23.8	-6.24	0.92				
4G/3G Band 1,2,3,4,9,23,25,35,39,66	1710-2200	Free Space.	52.7	-2.78	6.21				
		Ground Plane.	59.3	-2.27	4.39				
4G/3G Band 40	2300-2400	Free Space.	52.3	-2.81	4.39				
		Ground Plane.	52.0	-2.84	2.76				
Wi-Fi 2400	2400-2500	Free Space.	50.2	-2.99	4.30				
		Ground Plane.	48.6	-3.14	2.28				
4G/3G Band 7,38,41	2490-2690	Free Space.	50.2	-2.99	3.29				
		Ground Plane.	48.2	-3.17	1.92				

* The G30 antenna performance was measured with 30X30 cm metal ground plane.

Mechanical	
Dimensions (mm)	Height=48mm and Diameter=50mm
Weight	66g
Material	UV Resistant ABS
Connector	SMA(M) Fully Customizable
Cable	1m of RG316
Base and Thread	Nickel plated steel
Weather proof gasket	CR4305 foam with 3M9448B double-side adhesive
Nut	M12
Sealant	Rubber Stopper

Environmental	
Temperature Range	-40°C to +85°C
Protection	IP67
Corrosion	5% NACI for 96hrs- Nickel plated steel base and thread
Thermal Shock	100 cycles -40°C to +85°C
Humidity	Non-condensing 65 C 95% RH
Shock (Drop Test)	1m drop on concrete 6 axes
Cable Pull	8Kgf

5G/4G Bands				
Band Number	5GNR / FR1 / LTE / LTE-Advanced / WCDMA / HSPA / HSPA+ / TD-SCDMA			
	Uplink	Downlink	Free Space	Ground Plane
B1	1920 to 1980	2110 to 2170	✓	✓
B2	1850 to 1910	1930 to 1990	✓	✓
B3	1710 to 1785	1805 to 1880	✓	✓
B4	1710 to 1755	2110 to 2155	✓	✓
B5	824 to 849	869 to 894	✓	✓
B7	2500 to 2570	2620 to 2690	✓	✓
B8	880 to 915	925 to 960	✓	✓
B9*	17499 to 17849	18449 to 18799	✓	✓
B11	14279 to 14479	14759 to 14959	✓	✓
B12	699 to 716	729 to 746	✓	✓
B13	777 to 787	746 to 756	✓	✓
B14	788 to 798	758 to 768	✓	✓
B17	704 to 716	734 to 746	✓	✓
B18	815 to 830	860 to 875	✓	✓
B19	830 to 845	875 to 890	✓	✓
B20	832 to 862	791 to 821	✓	✓
B21	14479 to 14629	14959 to 15109	✓	✓
B22*	3410 to 3490	3510 to 3590	✓	✓
B23*	2000 to 2020	2180 to 2200	✓	✓
B24	16265 to 16605	1525 to 1559	✓	✓
B25	1850 to 1915	1930 to 1995	✓	✓
B26	814 to 849	859 to 894	✓	✓
B27*	807 to 824	852 to 869	✓	✓
B28	703 to 748	758 to 803	✓	✓
B29		717 to 728	✓	✓
B30	2305 to 2315	2350 to 2360	✓	✓
B31	4525 to 4575	4625 to 4675	✗	✗
B32		1452 to 1496	✓	✓
B34		2010 to 2025	✓	✓
B35		1850 to 1910	✓	✓
B36		1930 to 1990	✓	✓
B37		1910 to 1930	✓	✓
B38		2570 to 2620	✓	✓
B39		1880 to 1920	✓	✓
B40		2300 to 2400	✓	✓
B41		2496 to 2690	✓	✓
B42		3400 to 3600	✓	✓
B43		3600 to 3800	✓	✓
B45		1447 to 1467	✓	✓
B46		5150 to 5925	✓	✓
B47		5855 to 5925	✓	✓
B48		3550 to 3700	✓	✓
B49		3550 to 3700	✓	✓
B50		1432 to 1517	✓	✓
B51		1427 to 1432	✓	✓
B52		3300 to 3400	✓	✓
B53		24835 to 2495	✓	✓
B65	1920 to 2010	2110 to 2200	✓	✓
B66	1710 to 1780	2110 to 2200	✓	✓
B68	698 to 728	753 to 783	✓	✓
B69		2570 to 2620	✓	✓
B70	1695 to 1710	1995 to 2020	✓	✓
B71	663 to 698	617 to 652	✓	✓
B72	451 to 456	461 to 466	✗	✗
B73	450 to 455	460 to 465	✗	✗
B74	1427 to 1470	1475 to 1518	✓	✓
B75		1432 to 1517	✓	✓
B76		1427 to 1432	✓	✓
B77		3300 to 4200	✓	✓
B78		3300 to 3800	✓	✓
B79		4400 to 5000	✓	✓
B85	698 to 716	728 to 746	✓	✓
B87	410 to 415	420 to 425	✗	✗
B88	412 to 417	422 to 427	✗	✗

3. Antenna Characteristics

3.1 Test Setup

AUT



Vector Network Analyzer

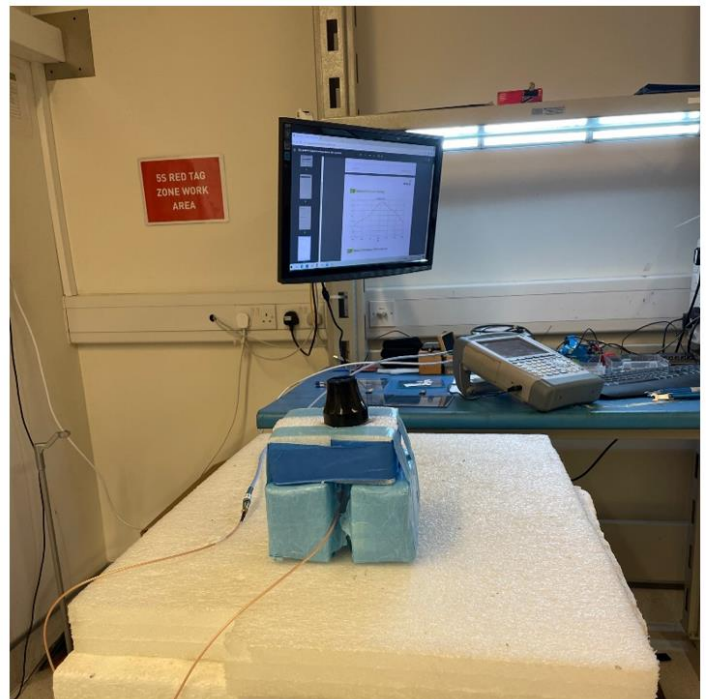
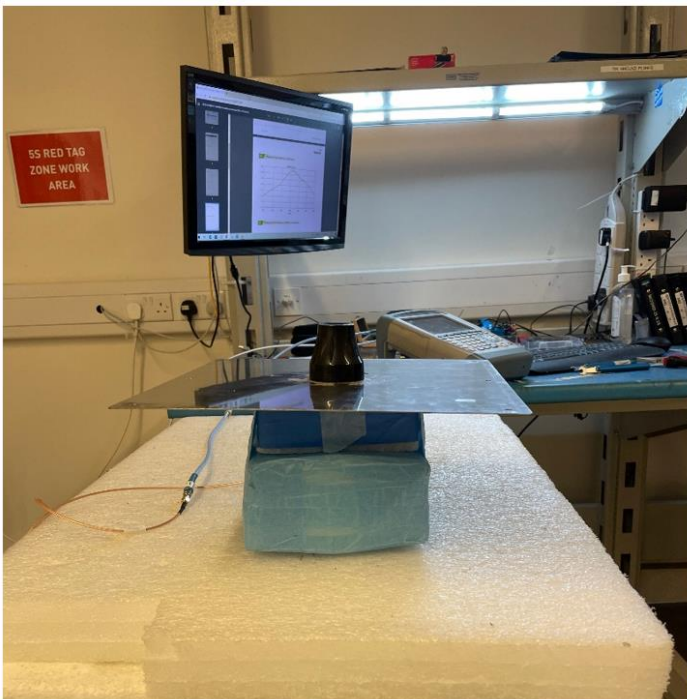

3.2 Return Loss

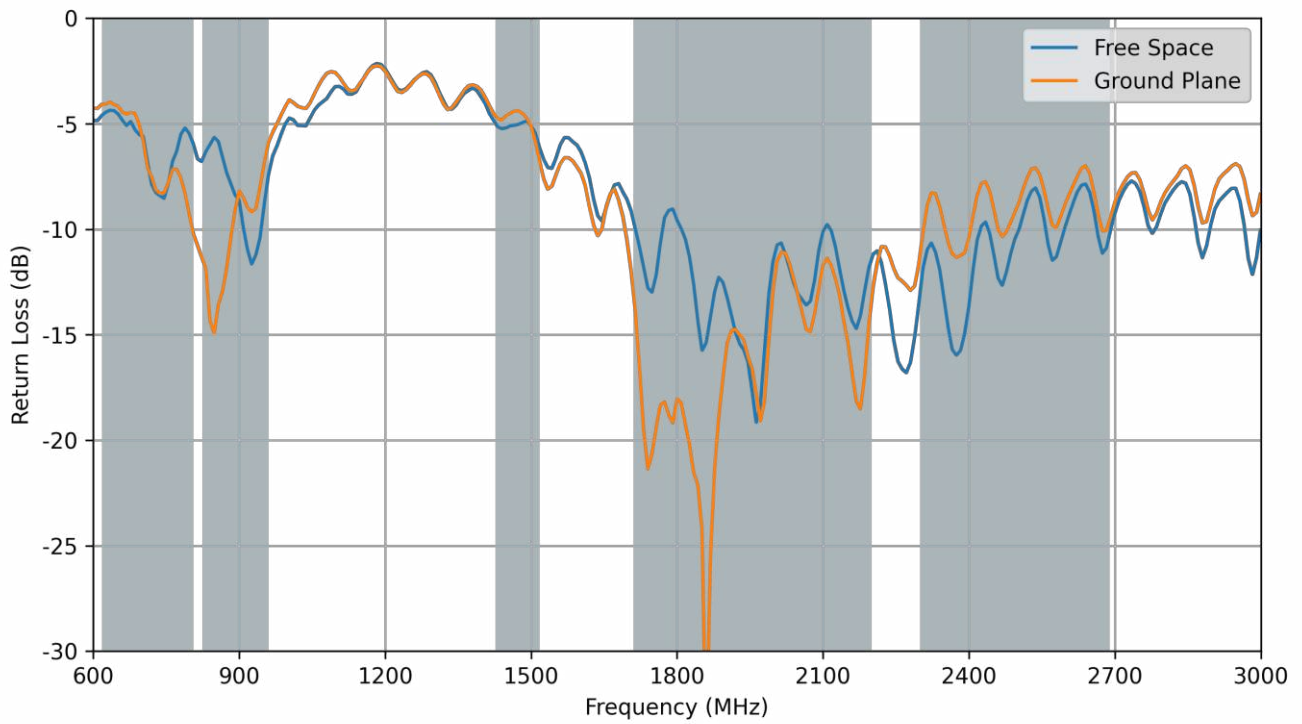

3.3 VSWR

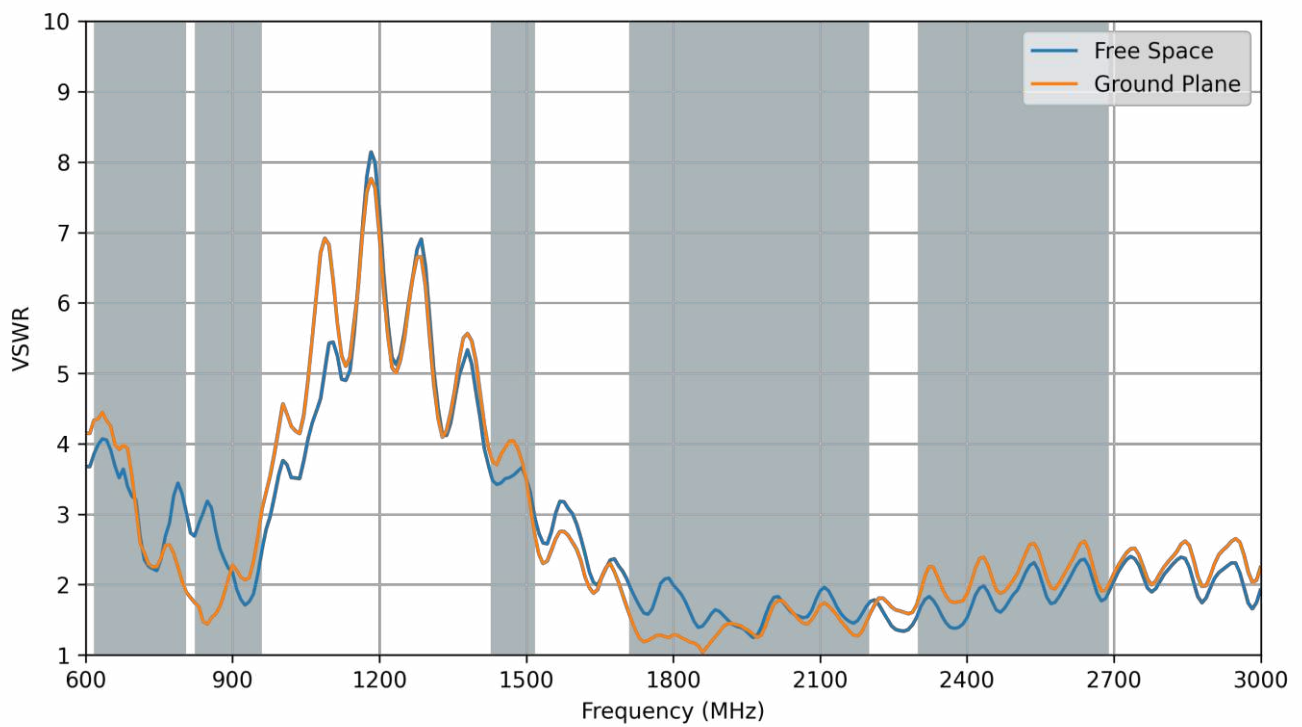

3.4 Efficiency

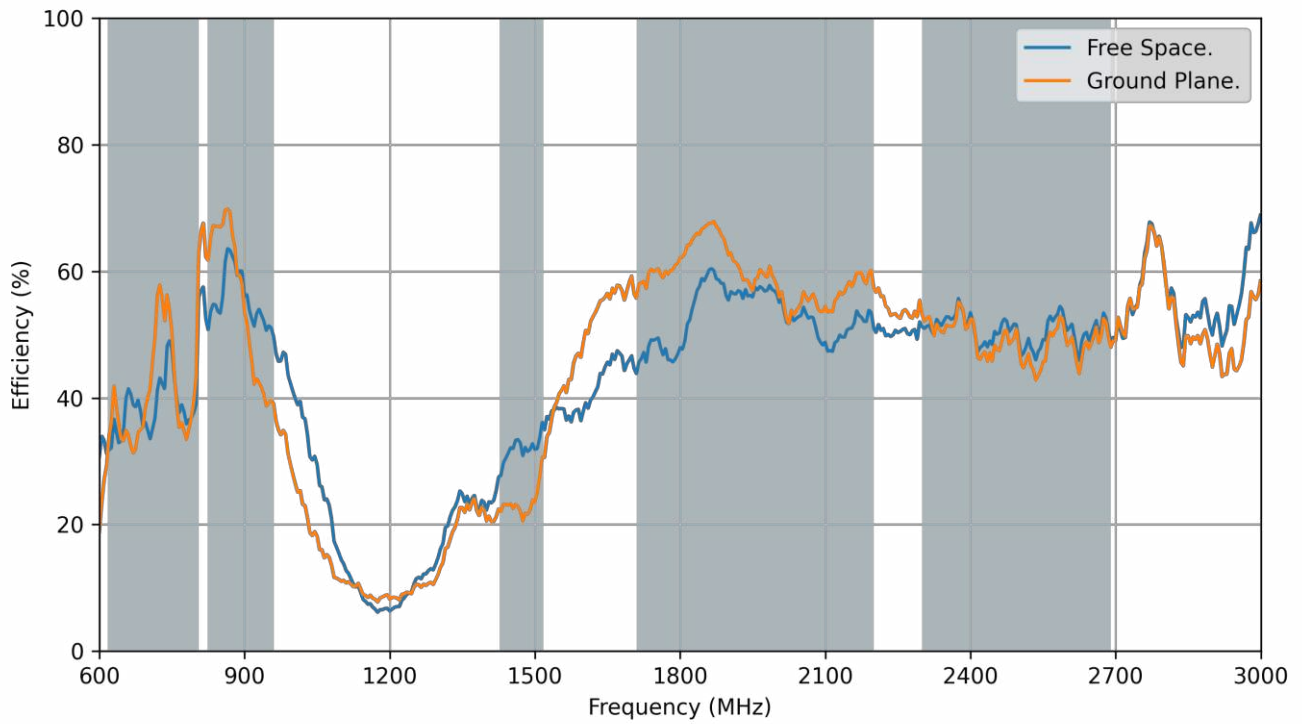

3.5 Average Gain

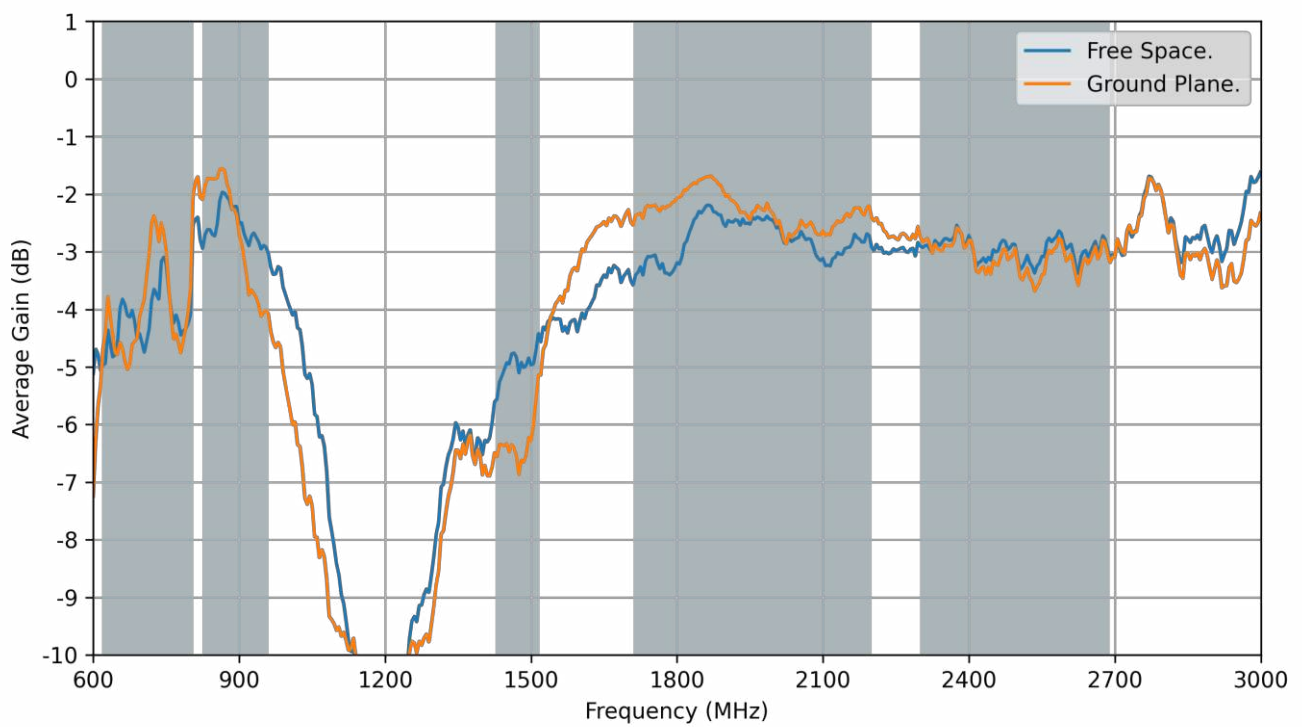

3.6 Peak Gain

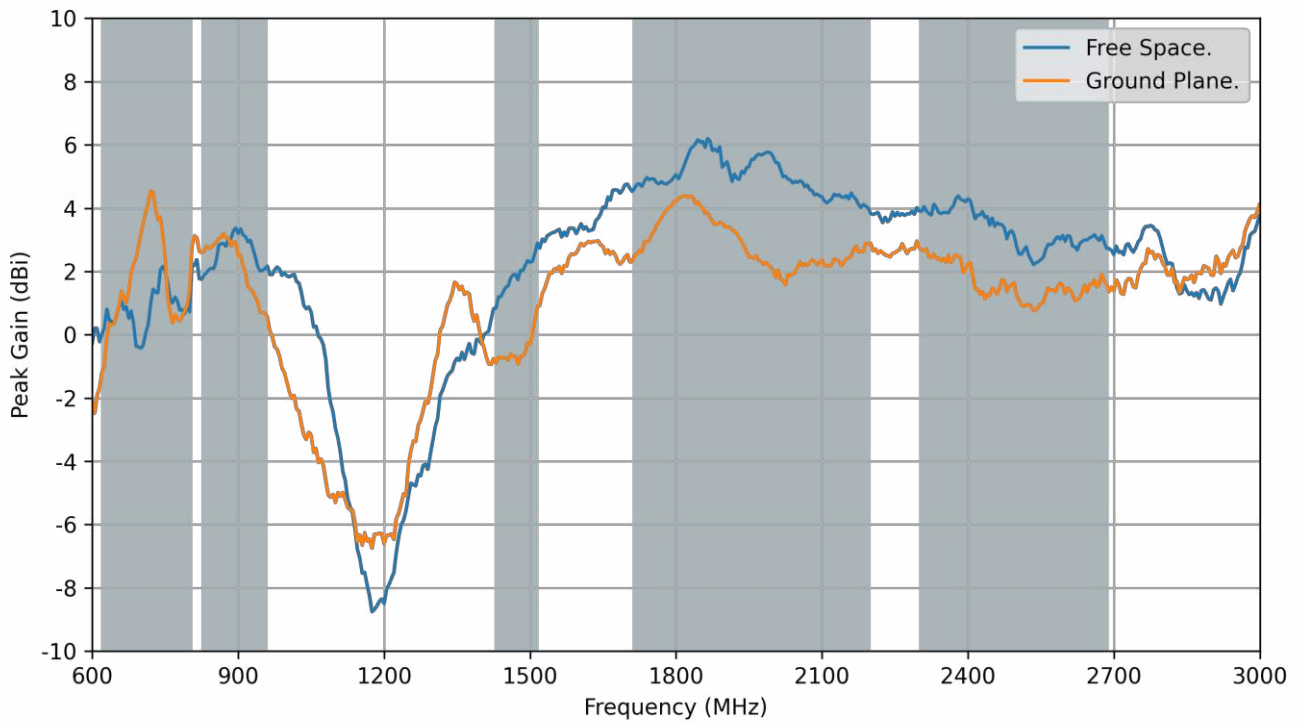

4. Radiation Patterns

4.1 Test Setup

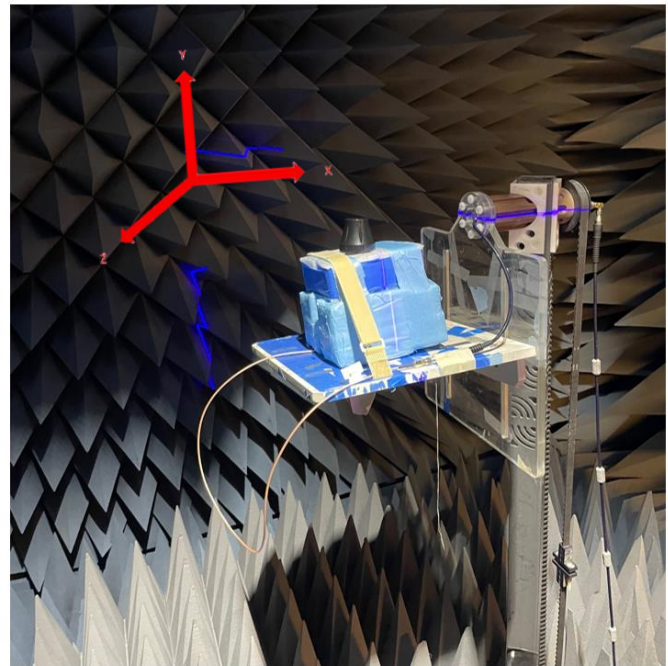
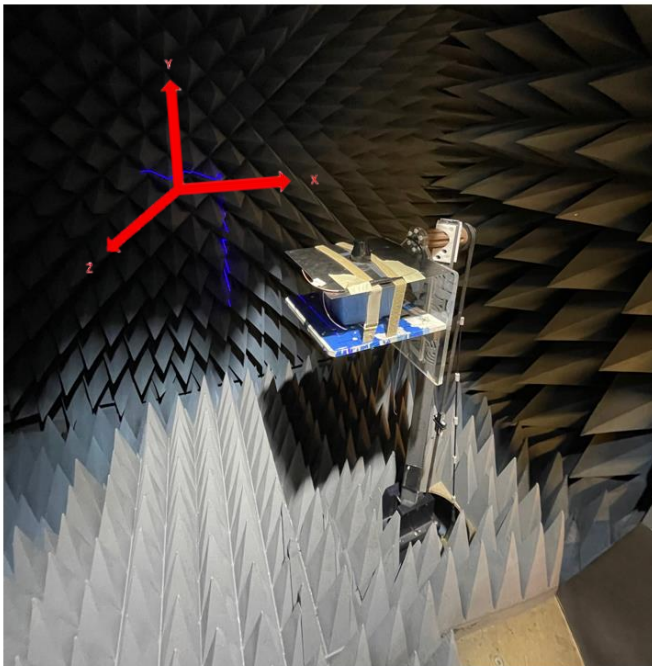
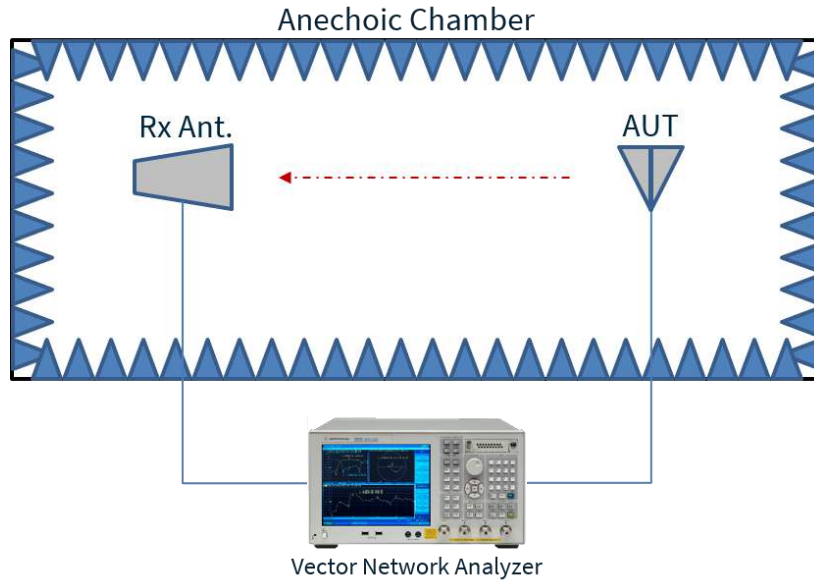

4.2 Free Space Patterns at 650 MHz

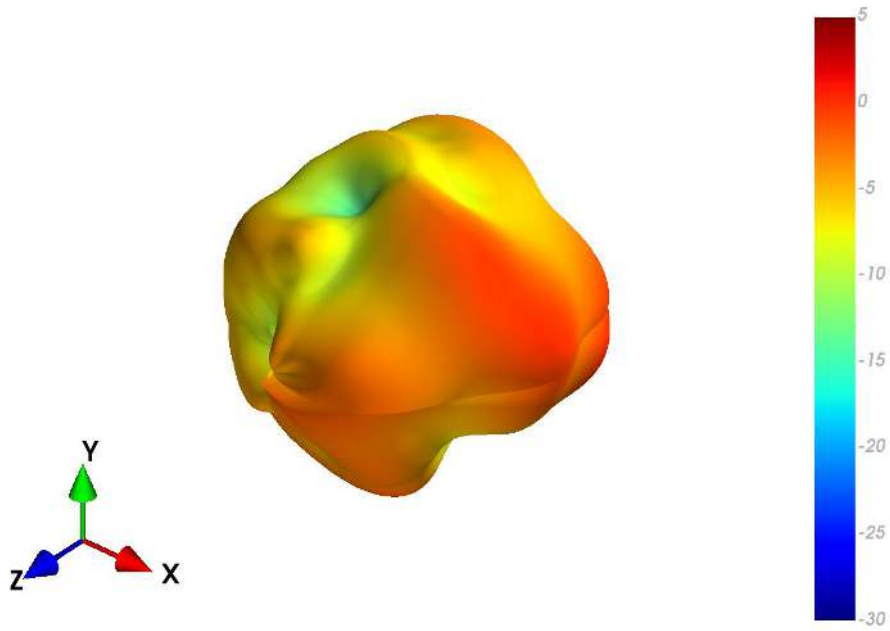

XZ Plane YZ Plane XY Plane

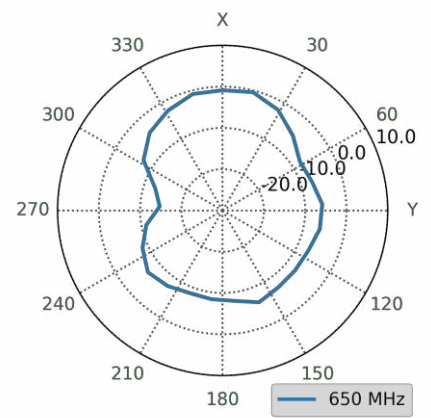
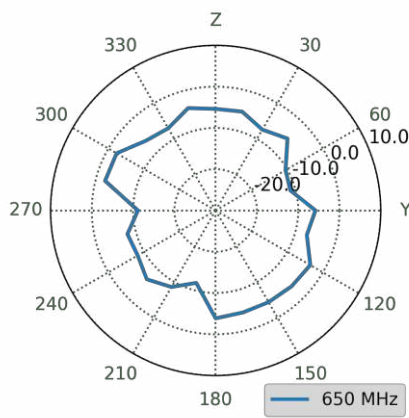
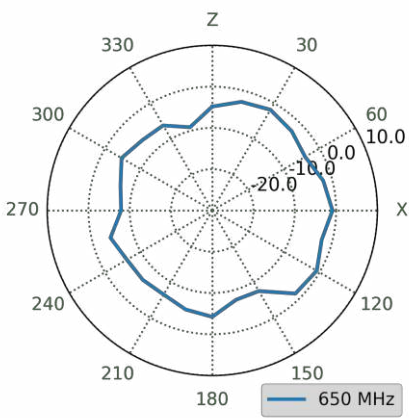

4.3 Ground Plane Patterns at 650 MHz

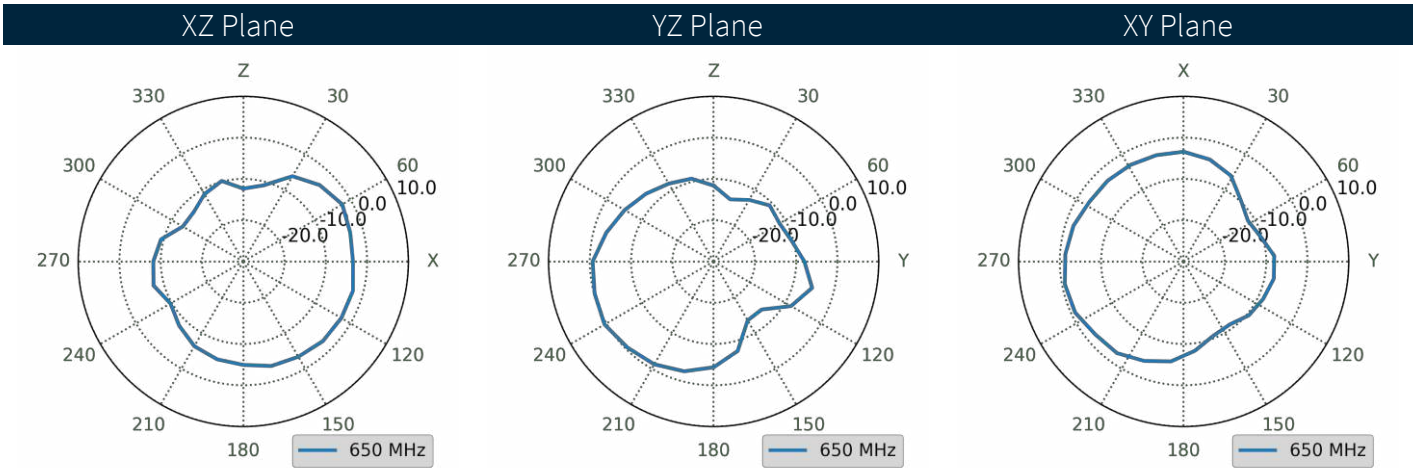
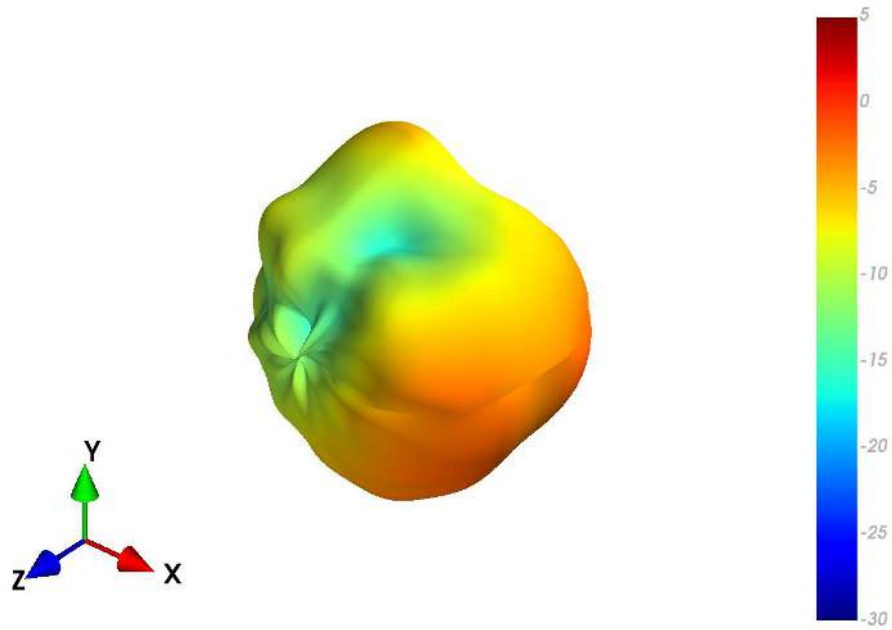

4.4 Free Space Patterns at 750 MHz

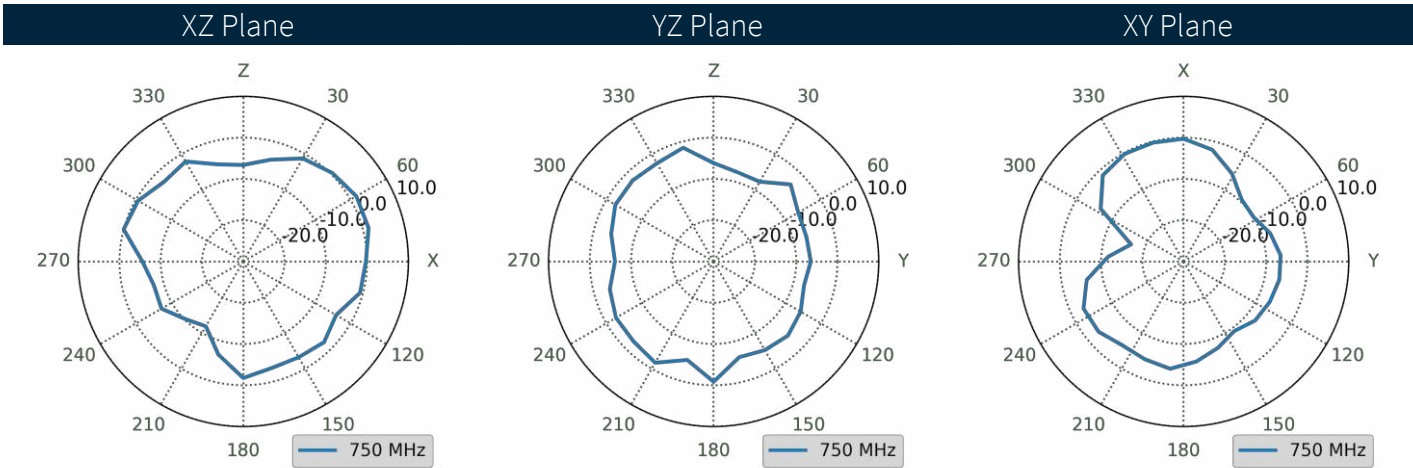
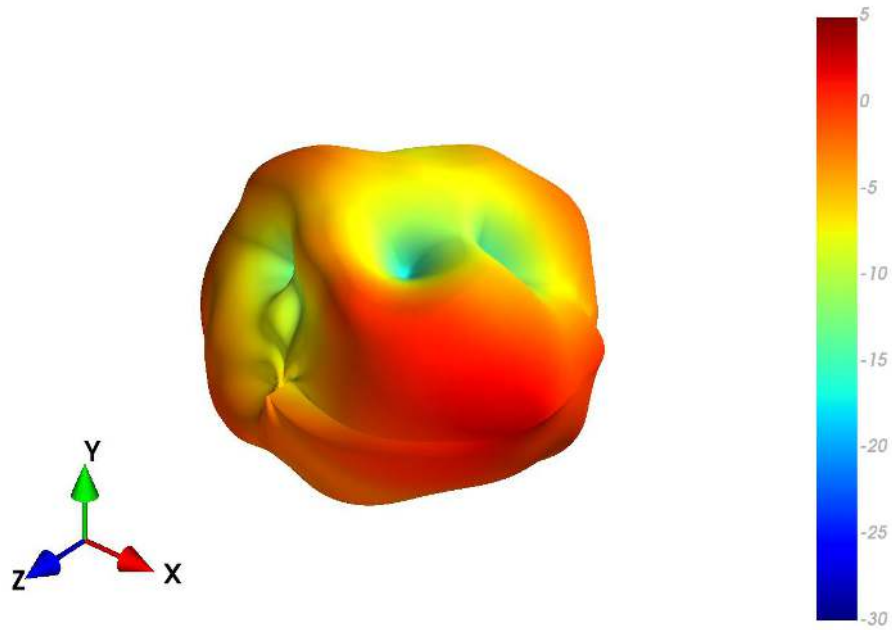

4.5 Ground Plane Patterns at 750 MHz

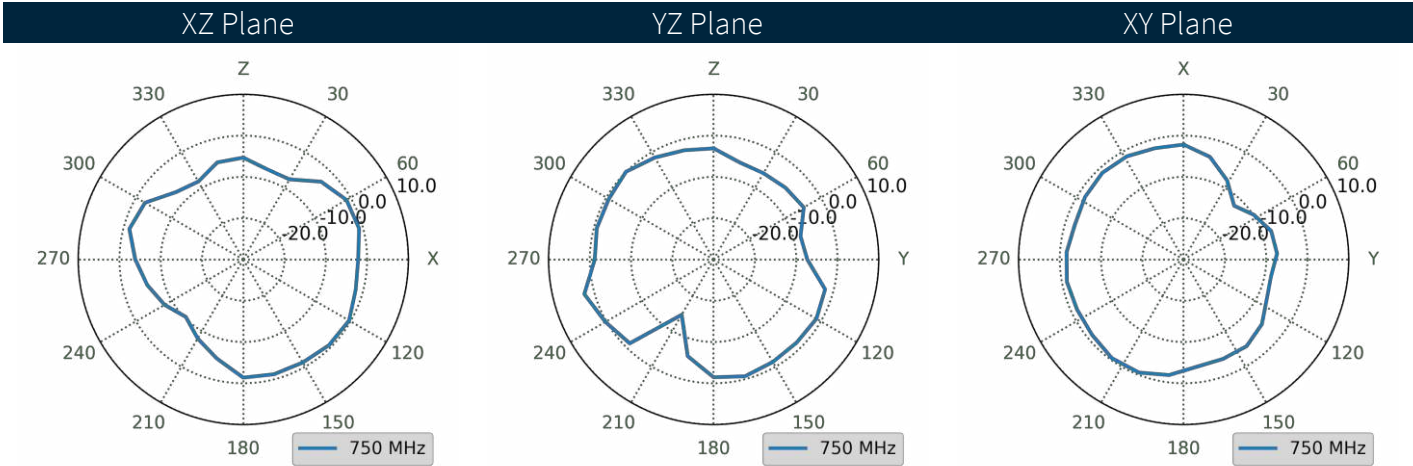
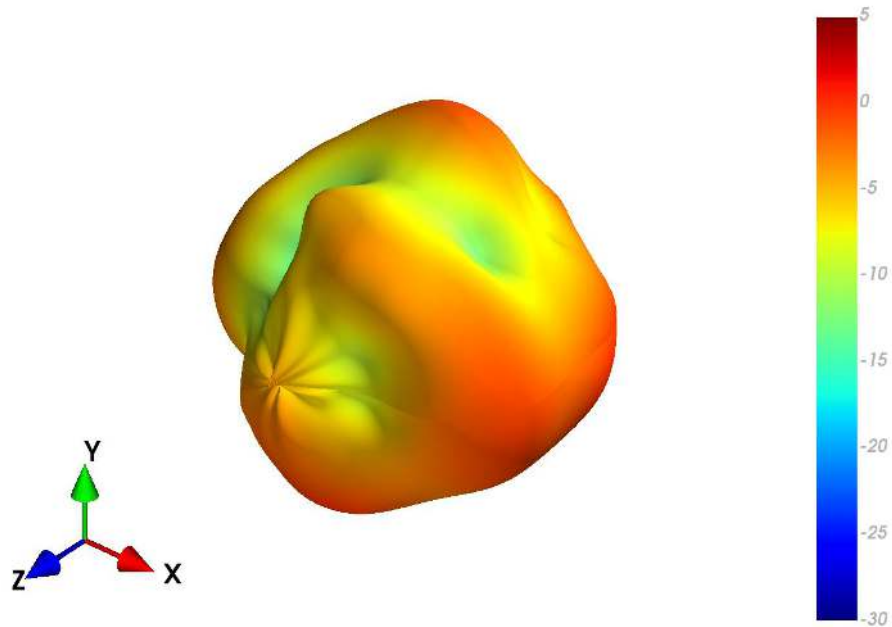

4.6 Free Space Patterns at 890 MHz

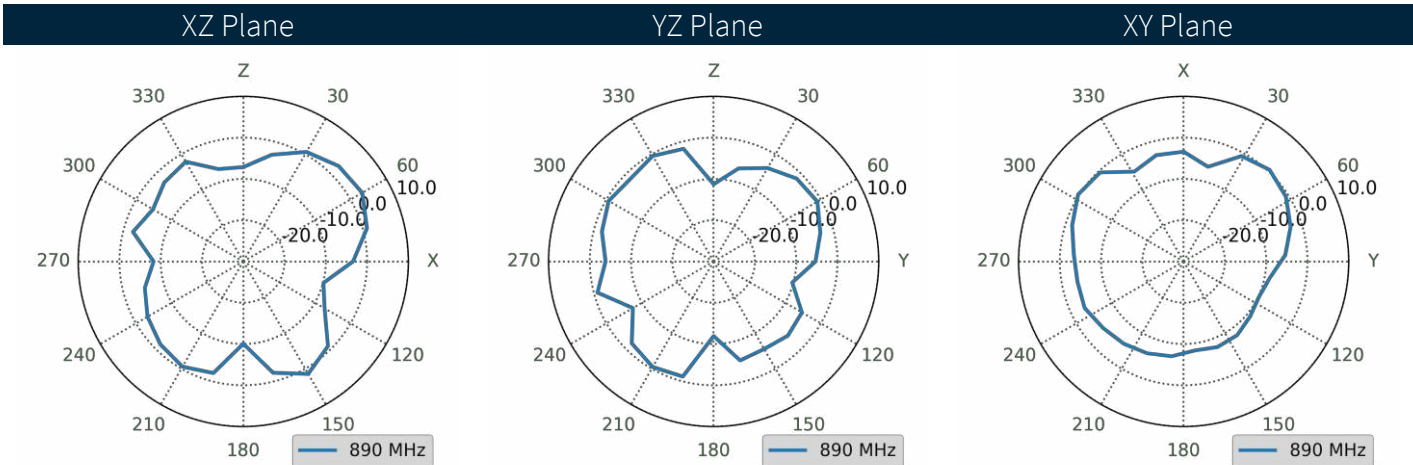
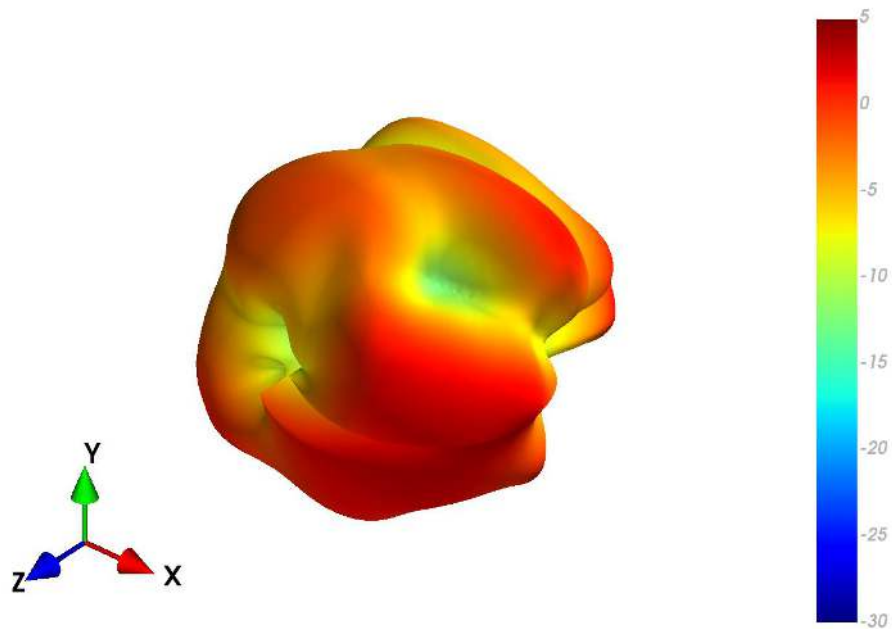

4.7 Ground Plane Patterns at 890 MHz

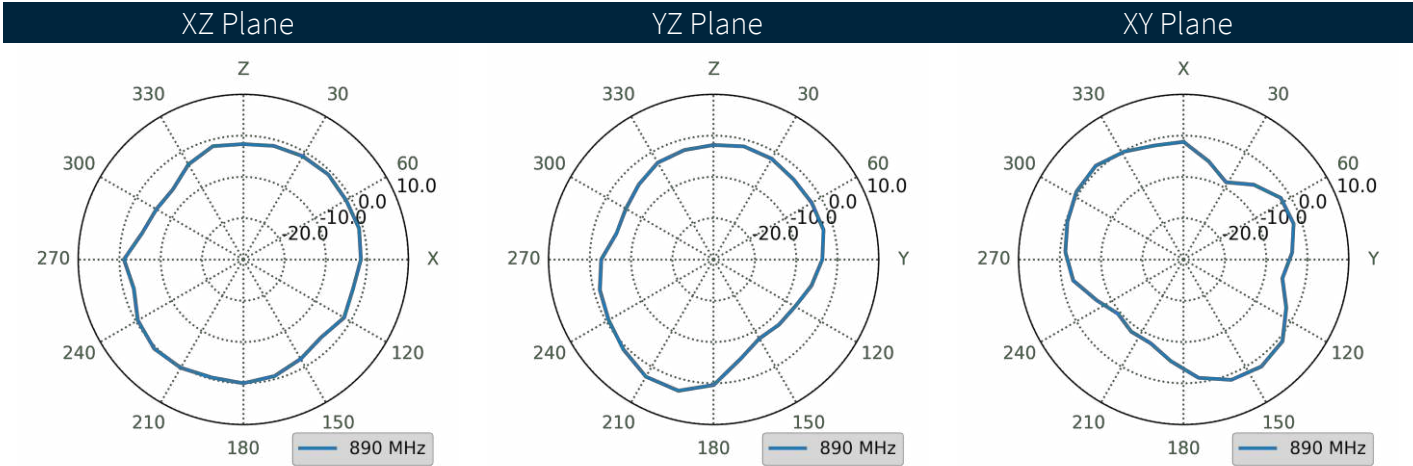
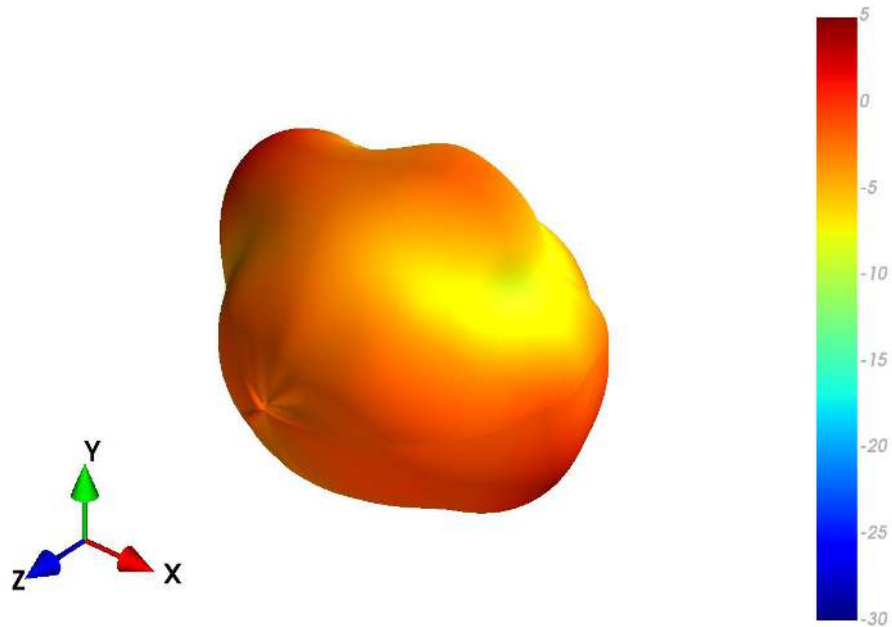

4.8 Free Space Patterns at 960 MHz

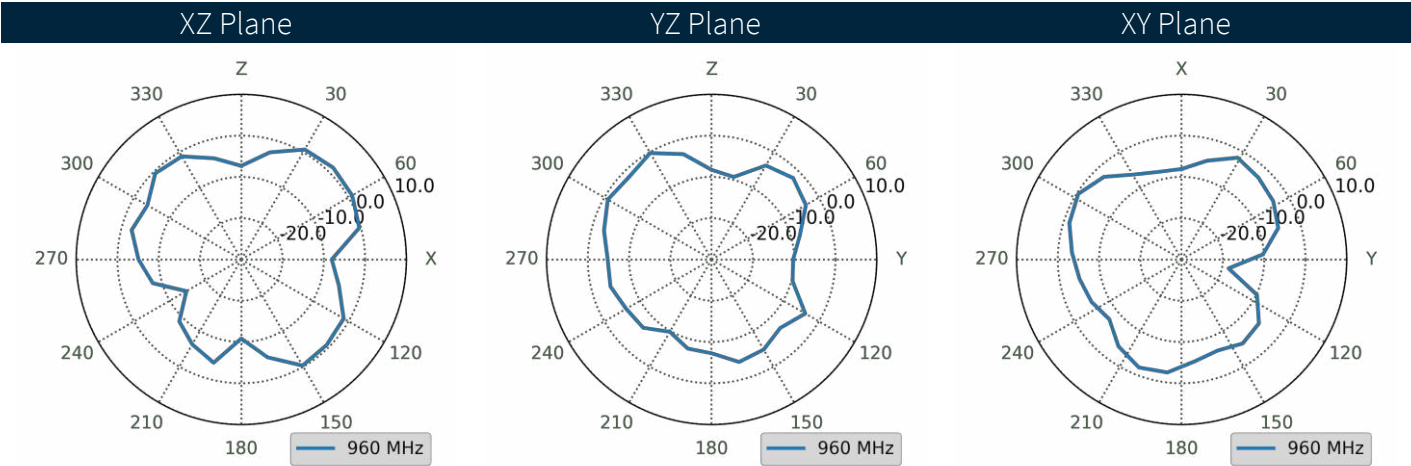
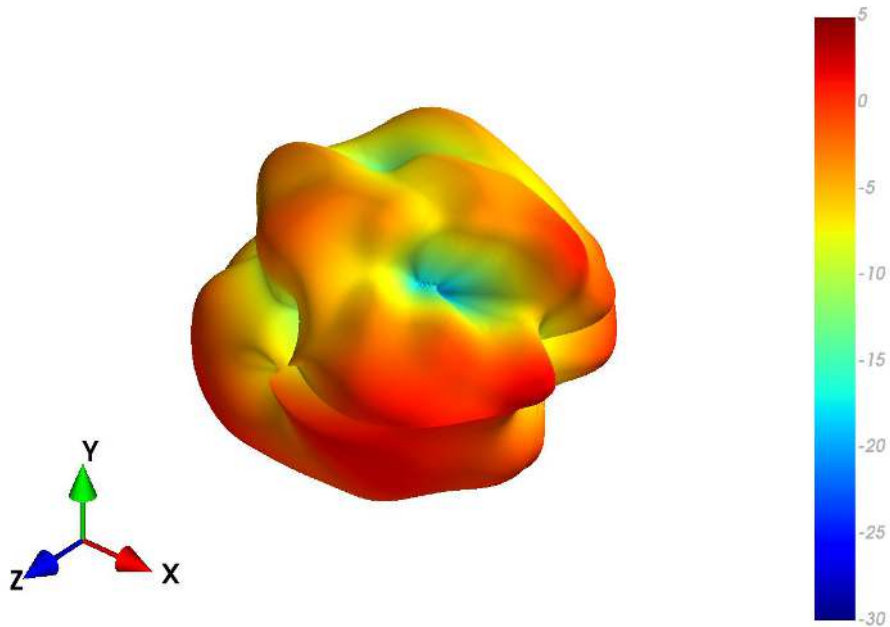

4.9 Ground Plane Patterns at 960 MHz

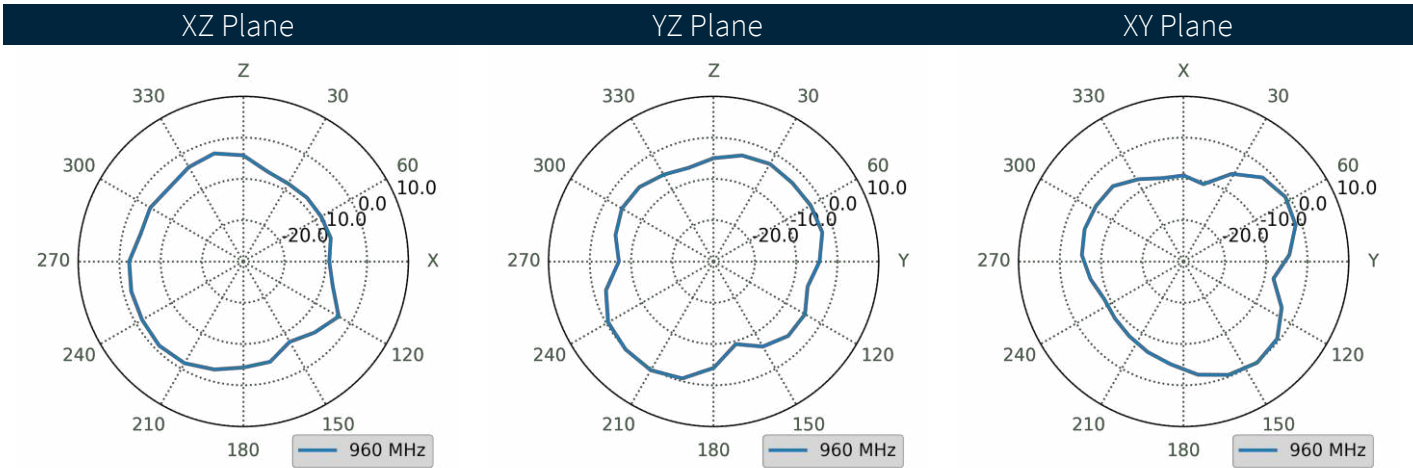
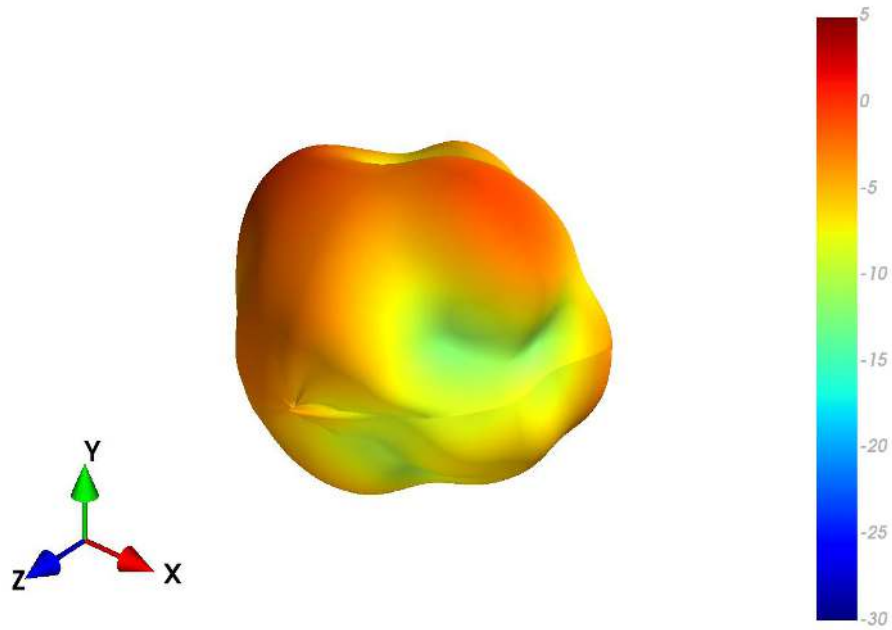

4.10 Free Space Patterns at 1470 MHz

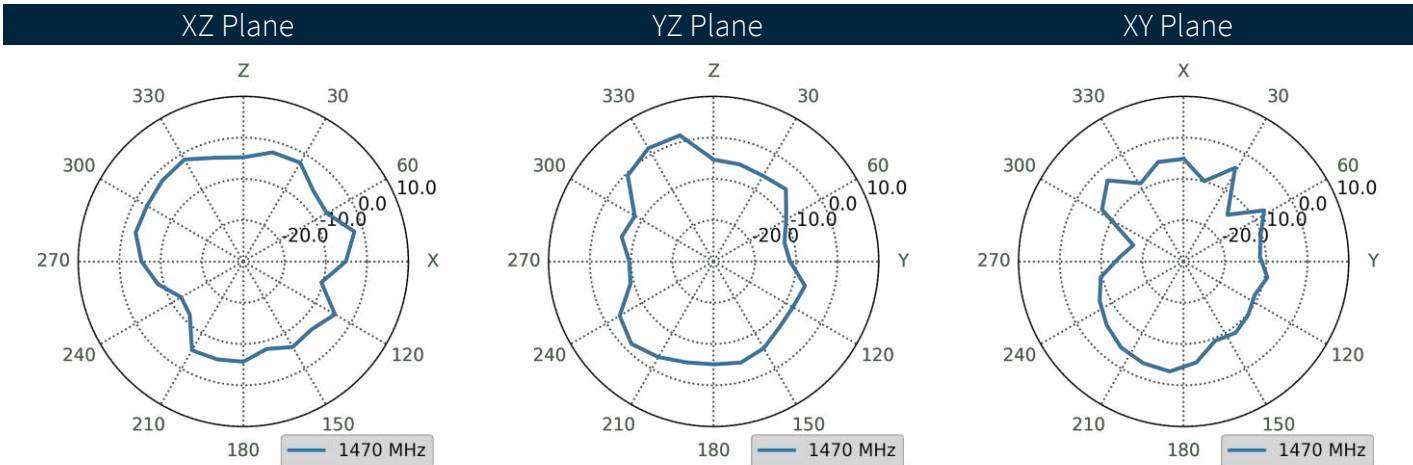
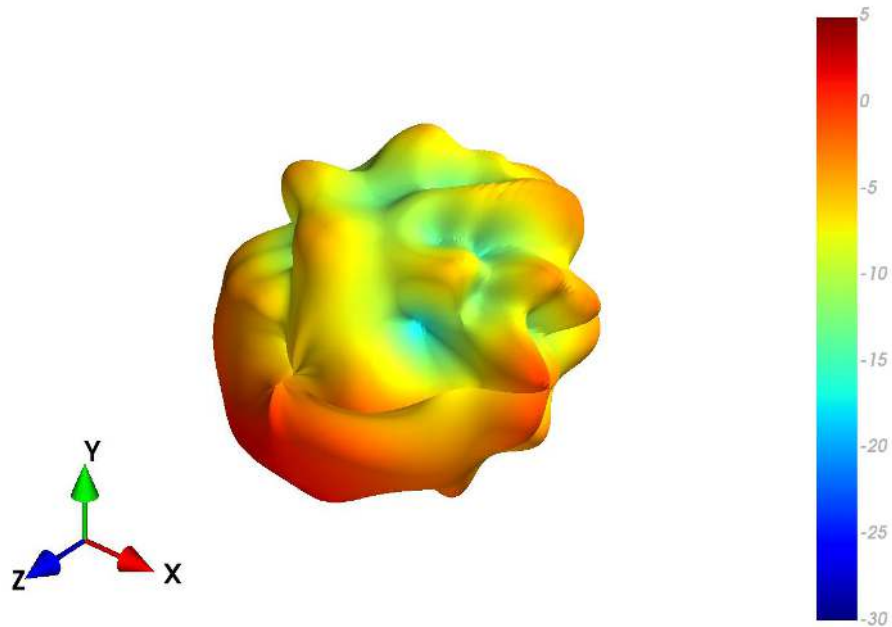

4.11 Ground Plane Patterns at 1470 MHz

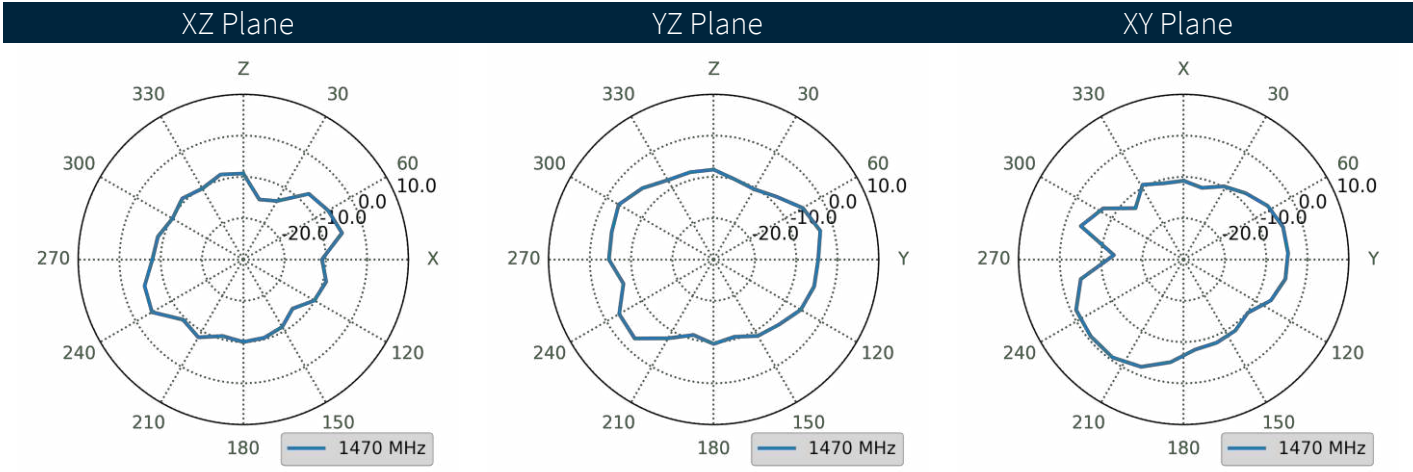
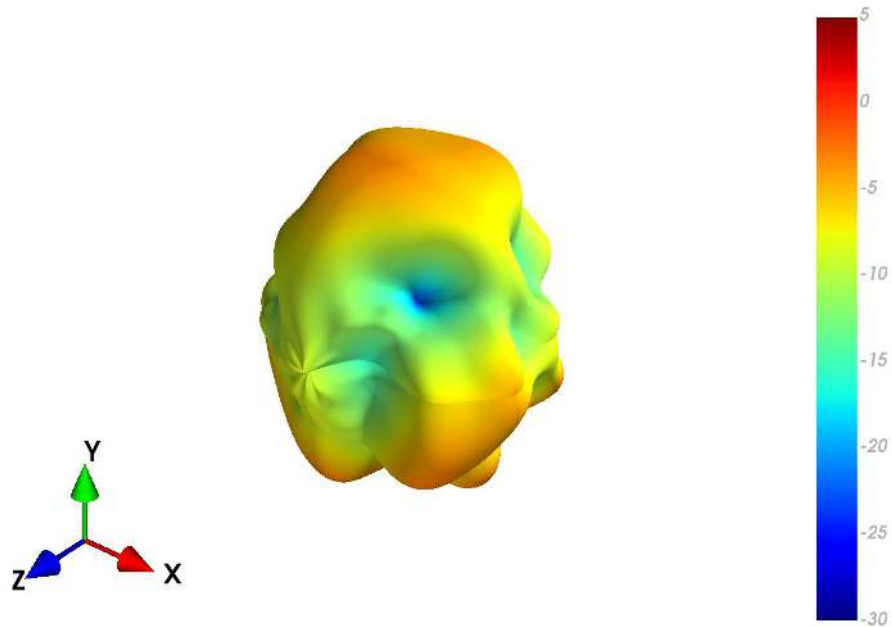

4.12 Free Space Patterns at 1805 MHz

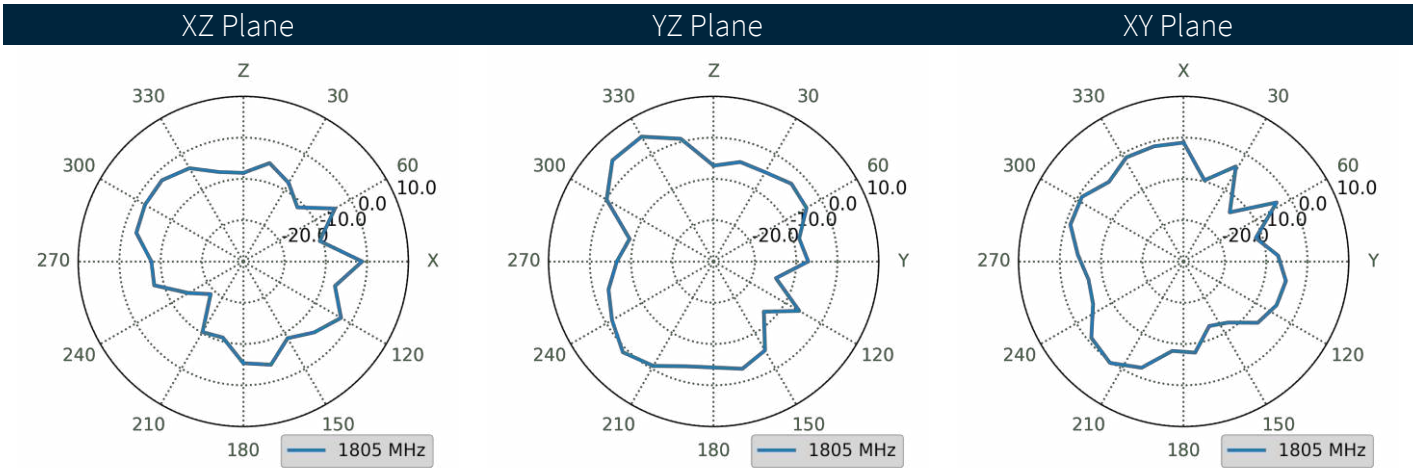
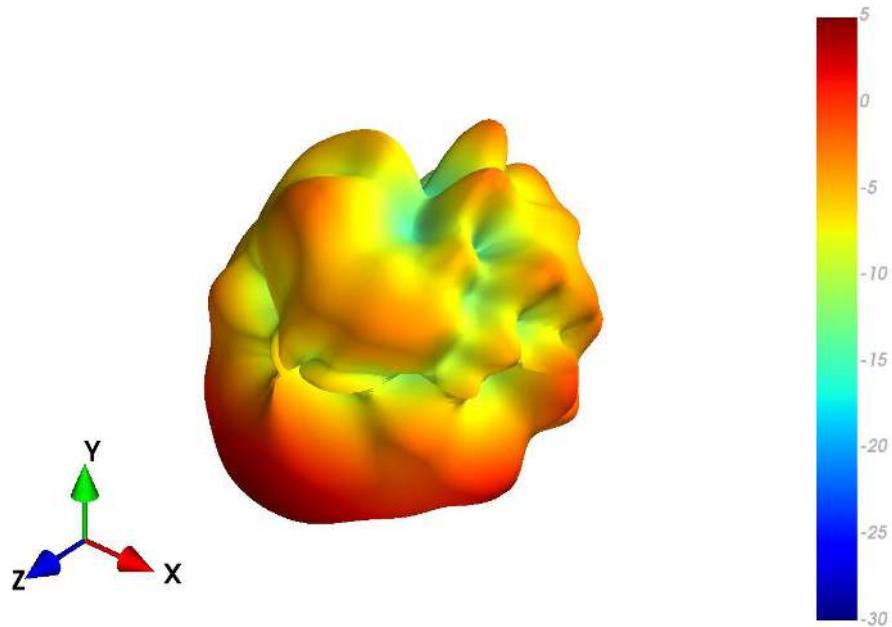

4.13 Ground Plane Patterns at 1805 MHz

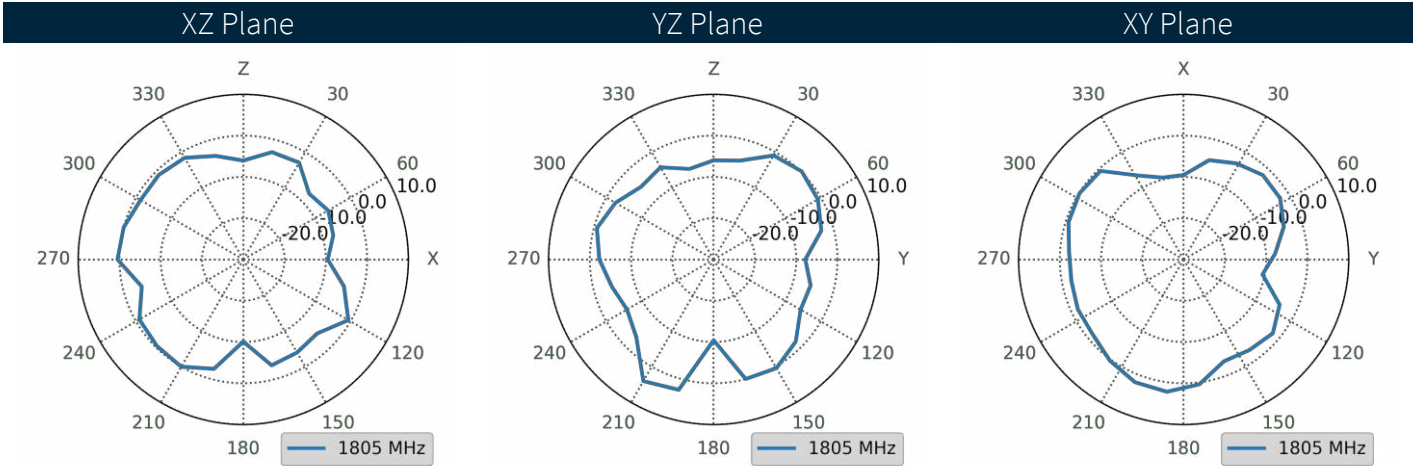
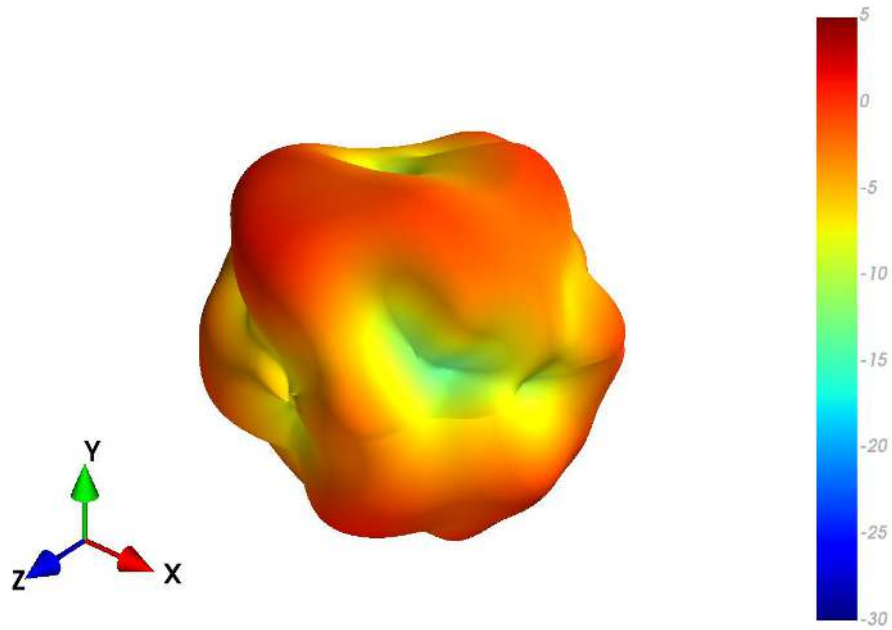

4.14 Free Space Patterns at 1920 MHz

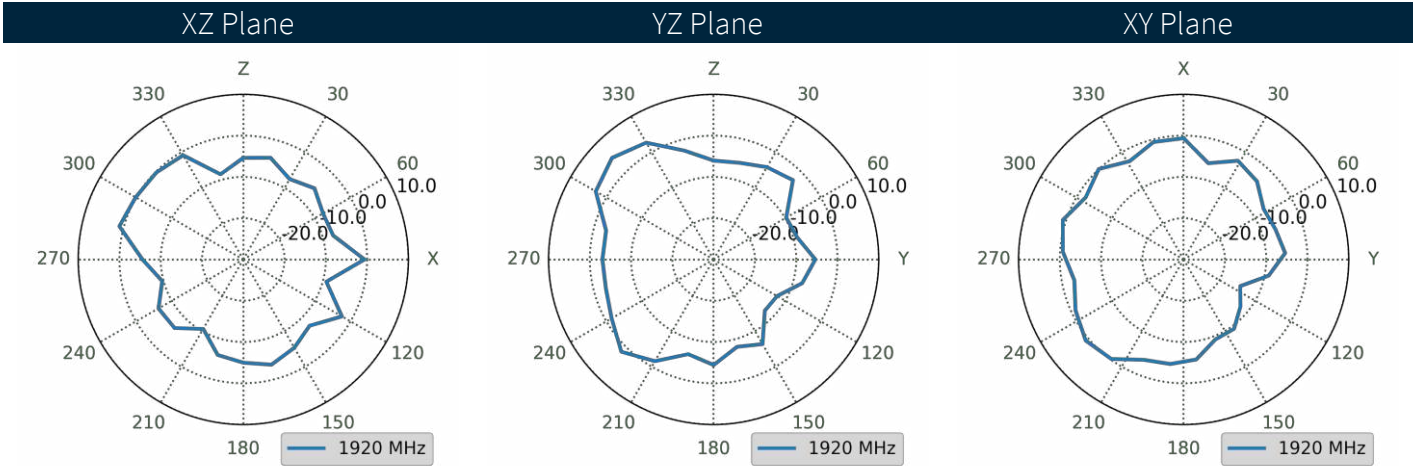
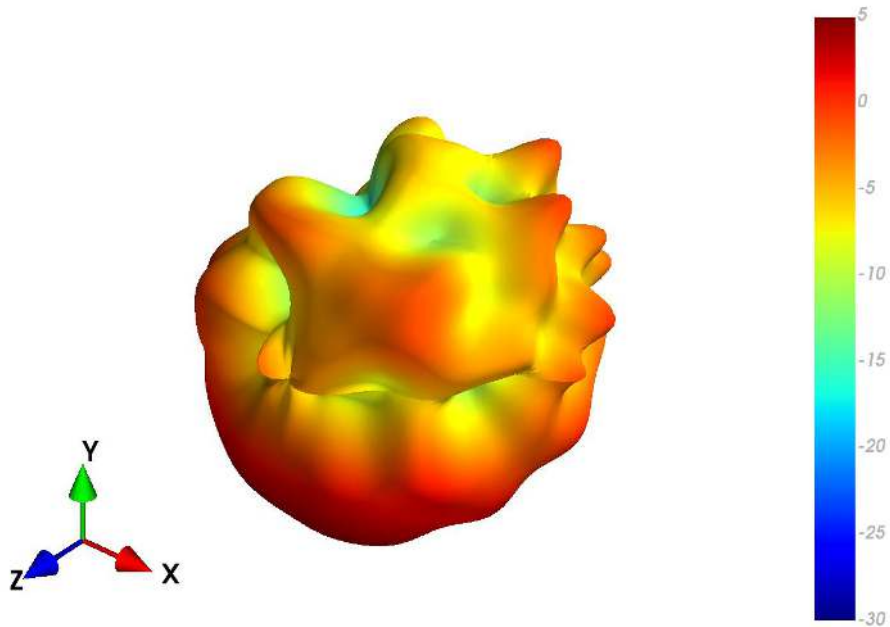

4.15 Ground Plane Patterns at 1920 MHz

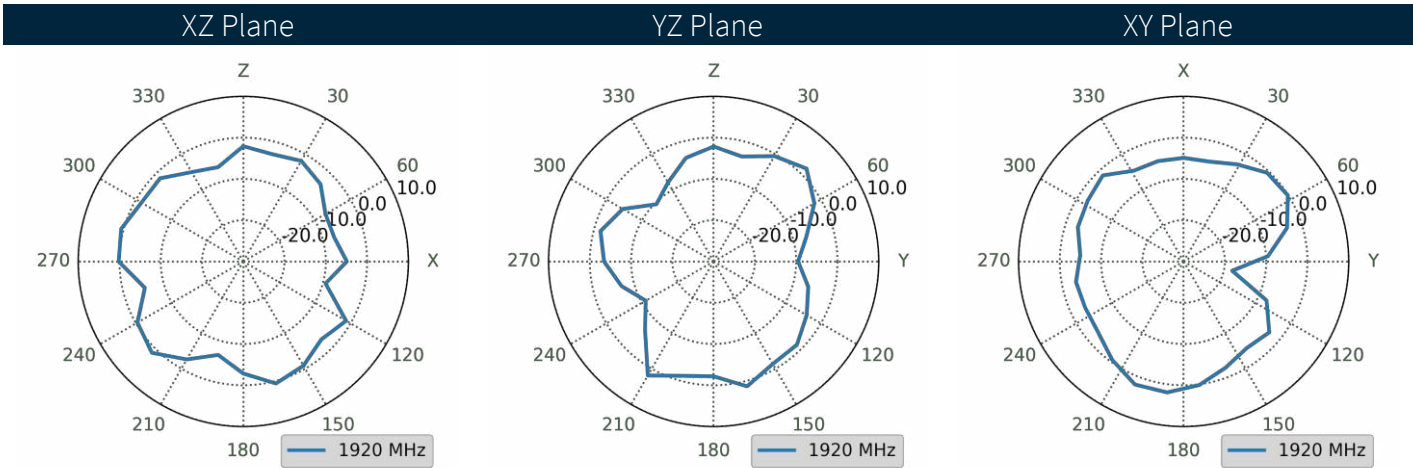
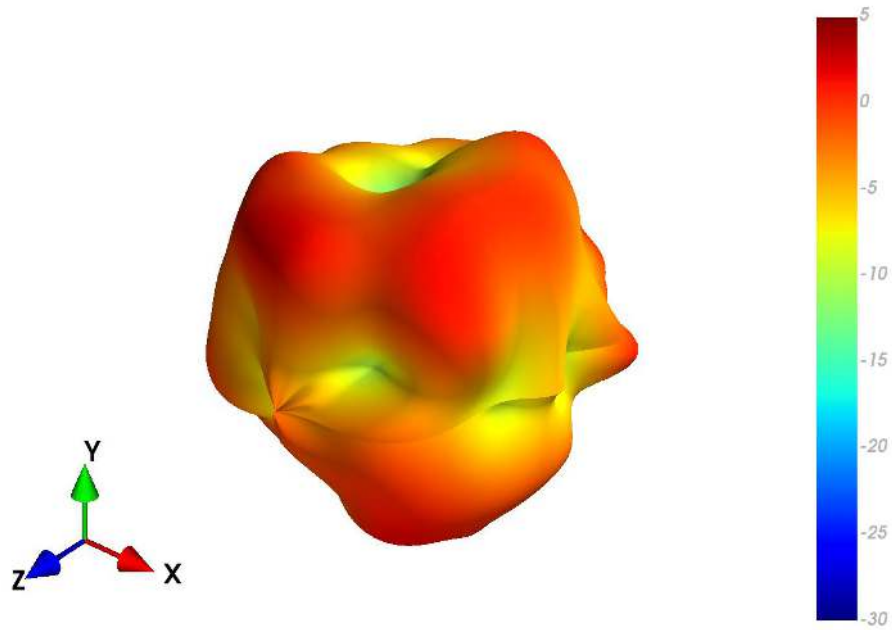

4.16 Free Space Patterns at 2595 MHz

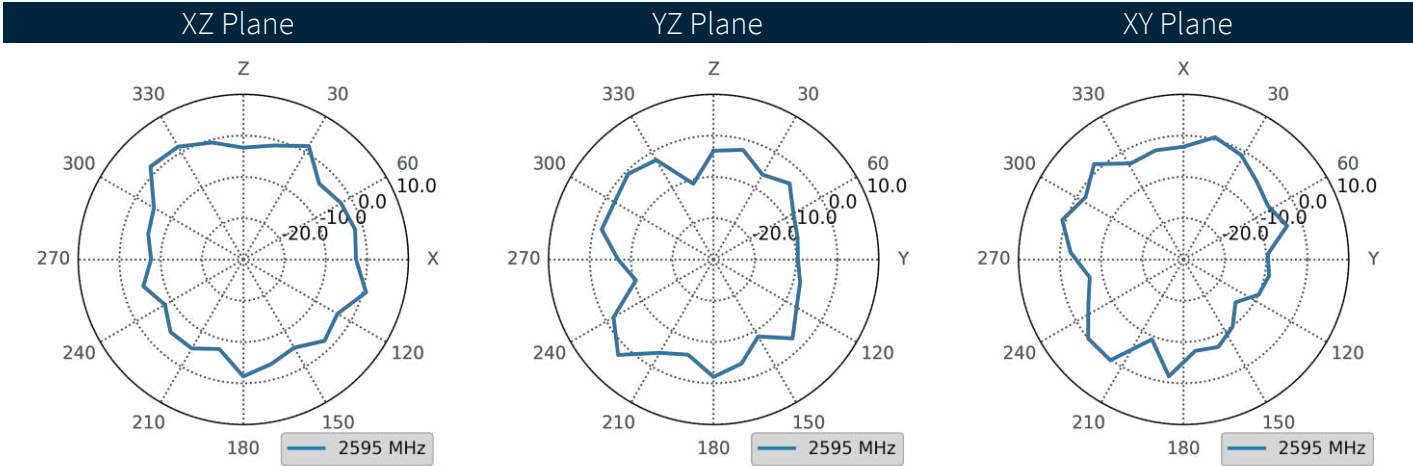
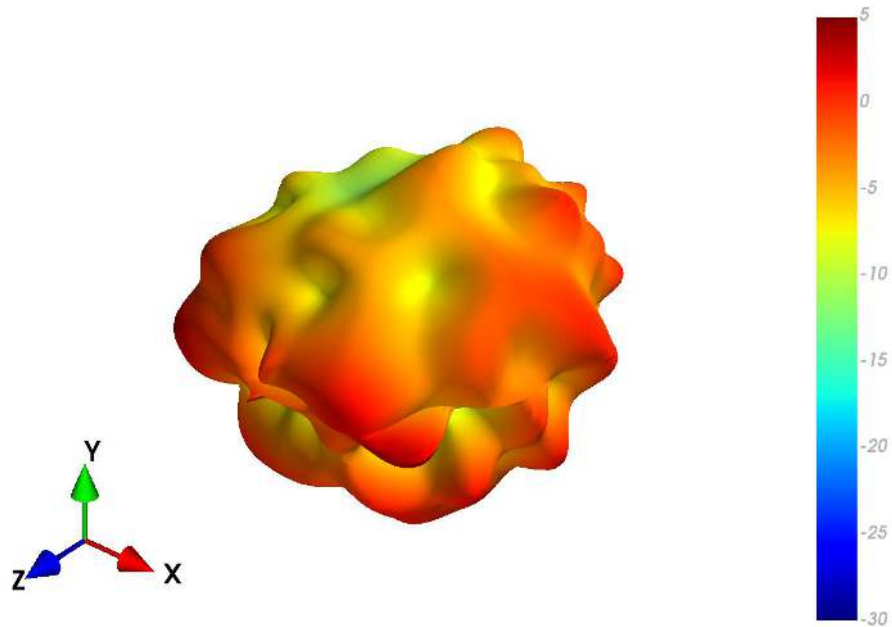

4.17 Ground Plane Patterns at 2595 MHz

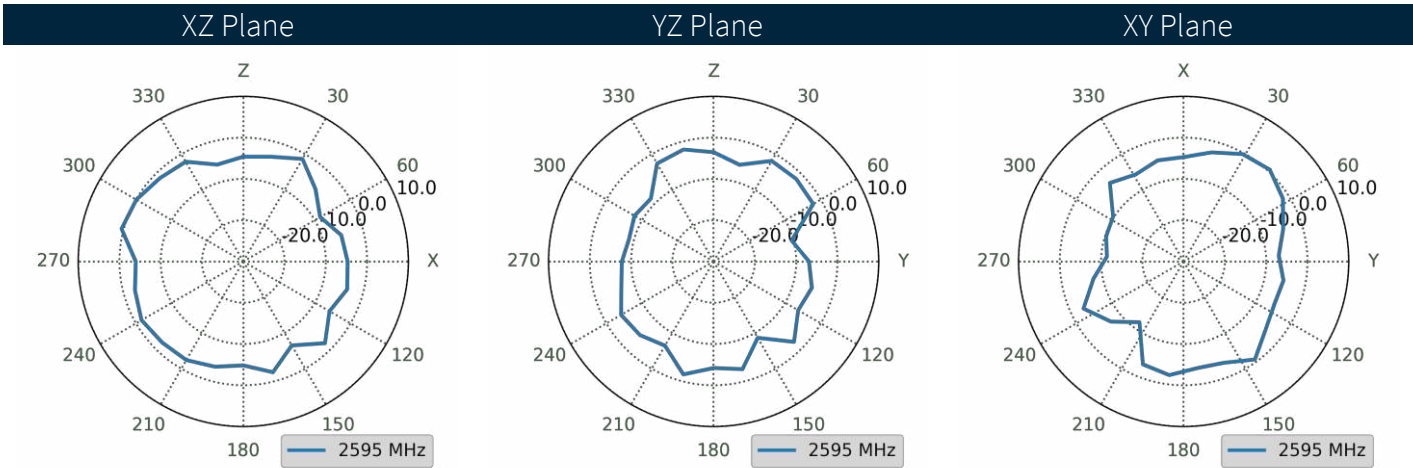
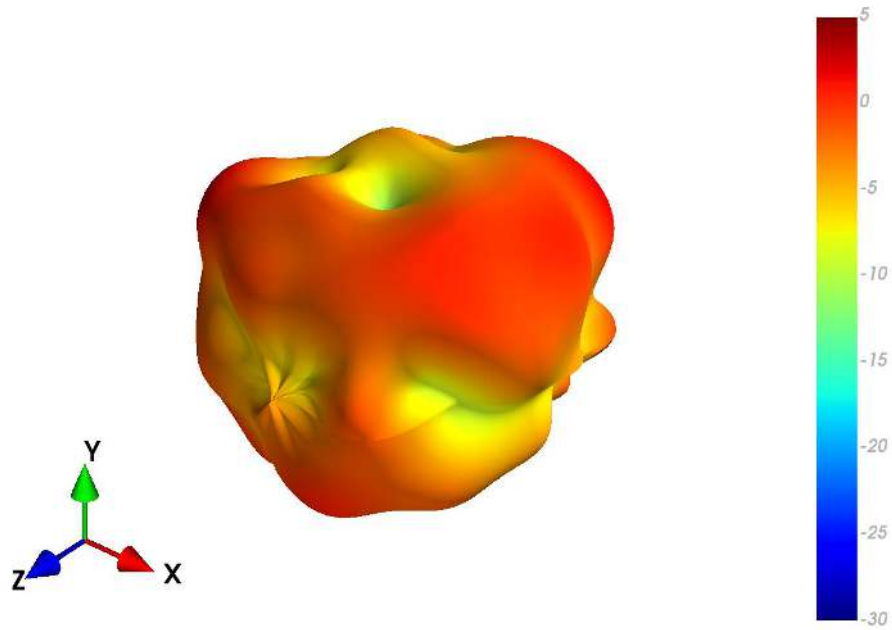

5. Mechanical Drawing

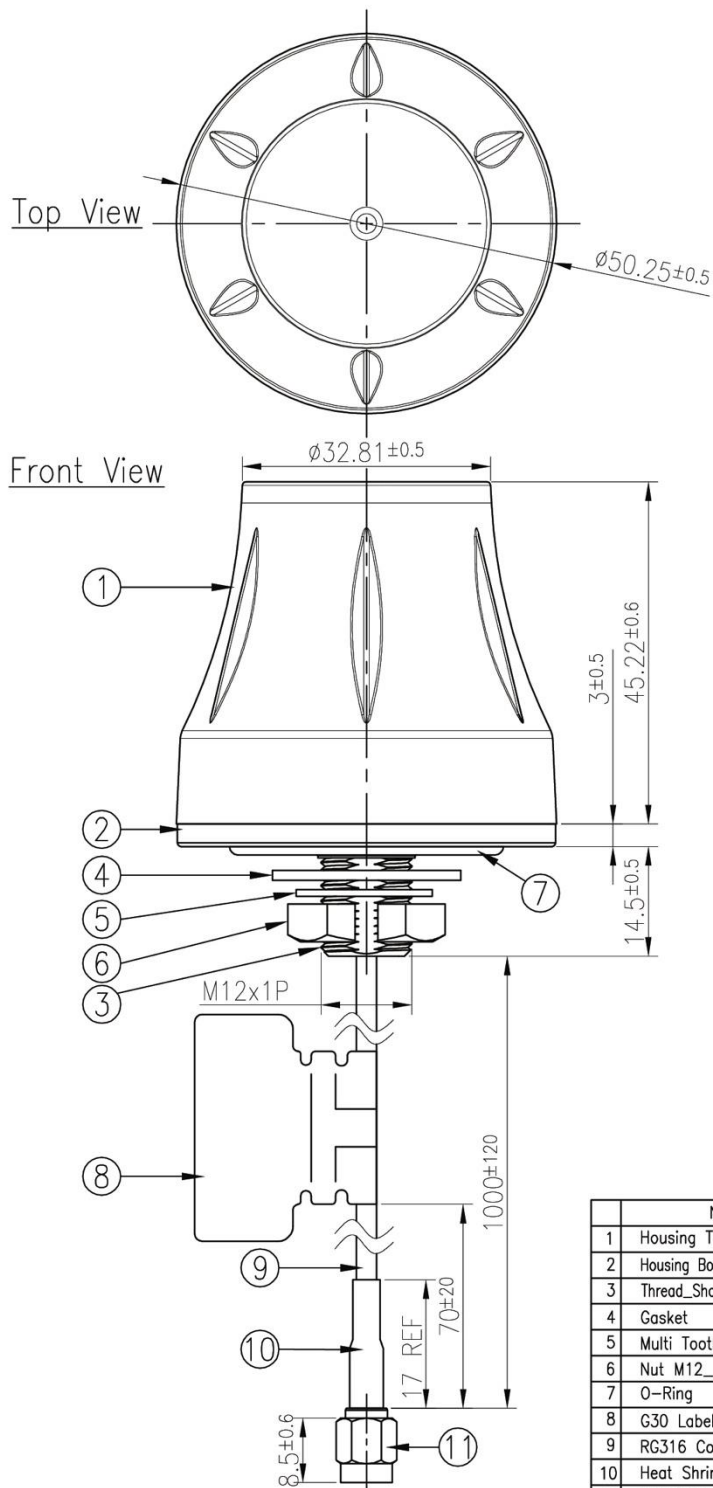

	Name	Material	Finish	QTY
1	Housing Top	ABS	Black	1
2	Housing Bottom	ABS	Black	1
3	Thread_Short	Brass	Ni Plated	1
4	Gasket	POM	Red	1
5	Multi Tooth Washer	Iron	Ni Plated	1
6	Nut M12_Cut	Copper	Ni Plated	1
7	O-Ring	Silicone	Black	1
8	G30 Label	PEPA	White	1
9	RG316 Coaxial Cable	FEP	Brown	1
10	Heat Shrink Tube	PE	Black	1
11	SMA(M)ST	Brass	Au Plated	1

6. Packaging

1pc G30.B.108111 per small PE bag
 Bag dimensions – 150*100mm
 Weight – 68g

10pcs G30.B.108111 per large PE bag
 Bag dimensions – 390*190mm
 Weight – 680g

80pcs G30.B.108111 per carton
 Carton dimensions – 495*225*270mm
 Weight – 6.2Kg

Pallet dimensions – 1200*1000*1550mm
 50 cartons per pallet
 10 cartons per layer
 5 layers

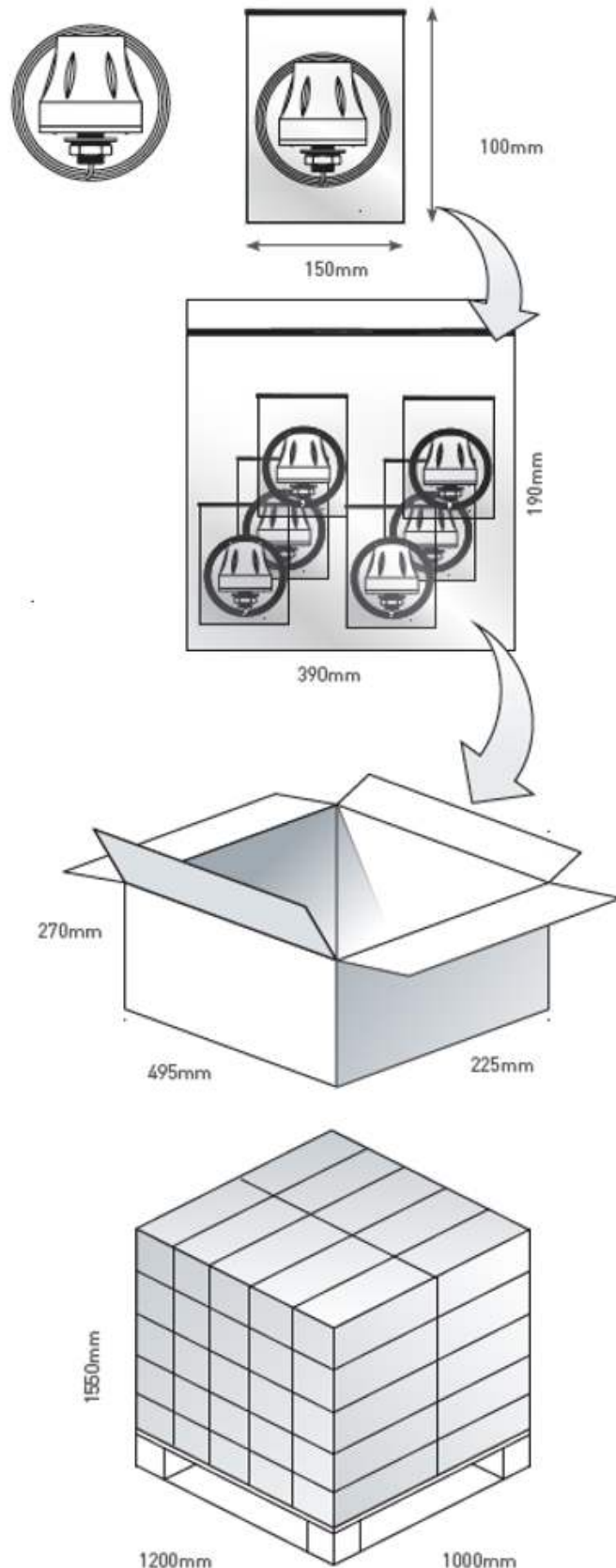

7. Installation Guide

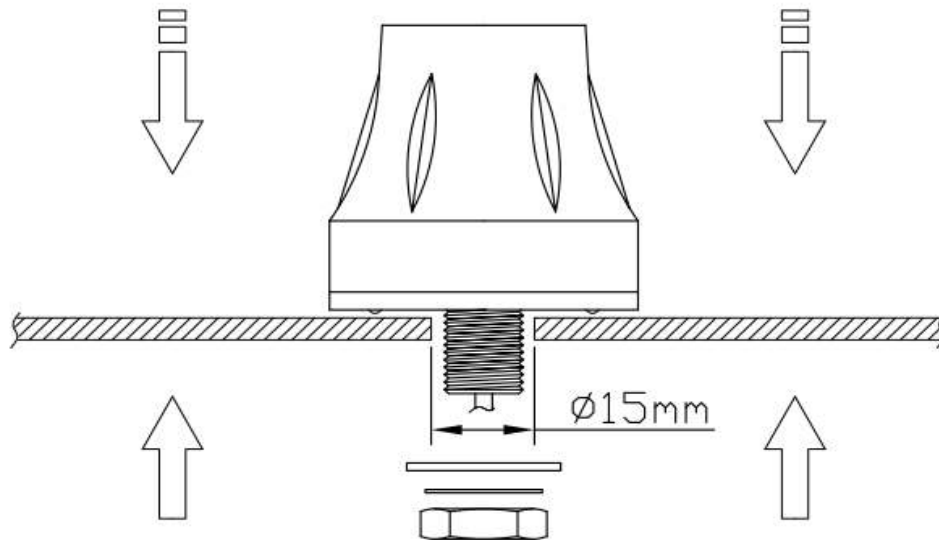

Recommended torque for mounting: 5-7Nm

(Torque value obtained with antenna mounted on 1mm thick SUS-316 bracket)

Changelog for the datasheet

SPE-12-8-149 - G30.B.108111

Revision: O (Current Version)

Date:	2023-01-25
Changes:	Full datasheet update (Adding band 40 to spec table)
Changes Made by:	Gary West

Previous Revisions

Revision: N

Date:	2018-02-02
Changes:	Per PCN-18-8-018
Changes Made by:	Carol

Revision: I

Date:	2016-04-26
Changes:	Amended Mounting Hole on Installation
Changes Made by:	Aine Doyle

Revision: M

Date:	Unknown
Changes:	
Changes Made by:	Technical Writer

Revision: H

Date:	2015-02-05
Changes:	Removed ref to TL.01 from the Intro
Changes Made by:	Aine Doyle

Revision: L

Date:	2017-04-04
Changes:	Added LTE band table
Changes Made by:	Pater Monahan

Revision: G

Date:	2014-04-23
Changes:	Added in weight, torque and packaging
Changes Made by:	Aine Doyle

Revision: K

Date:	2016-05-10
Changes:	Amended drawings as per PCN
Changes Made by:	Andy Mahoney

Revision: F

Date:	2014-04-22
Changes:	Added in 2400Mhz detail
Changes Made by:	Aine Doyle

Revision: J

Date:	Unknown
Changes:	
Changes Made by:	Technical Writer

Revision: E

Date:	2013-04-26
Changes:	Updated packaging
Changes Made by:	Aine Doyle

Previous Revisions

Revision: D	
Date:	2013-02-06
Changes:	
Changes Made by:	Technical Writer

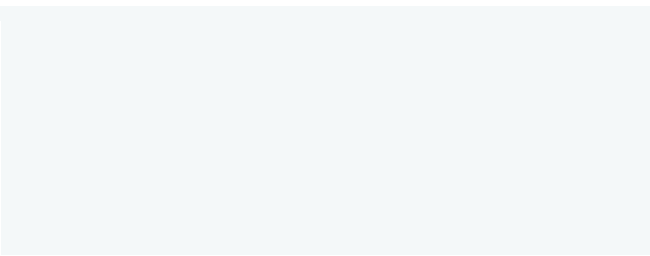

Revision: C	
Date:	2013-02-01
Changes:	
Changes Made by:	Technical Writer

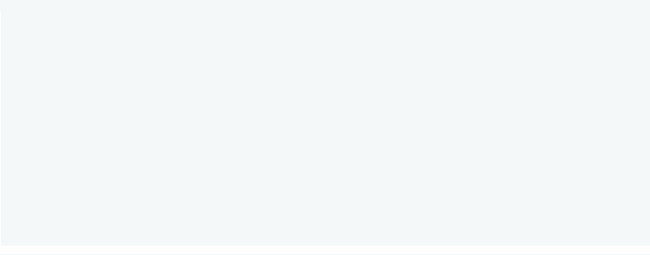

Revision: B	
Date:	2012-12-23
Changes:	
Changes Made by:	Technical Writer

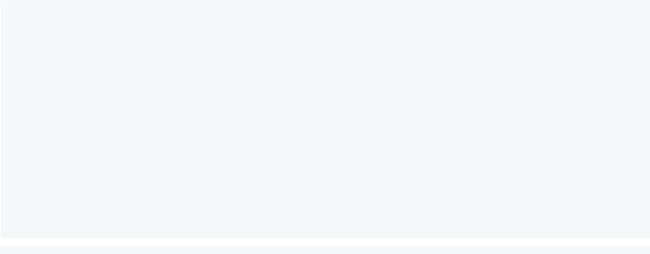

Revision: A (Original First Release)	
Date:	2012-12-13
Notes:	
Author:	Technical Writer

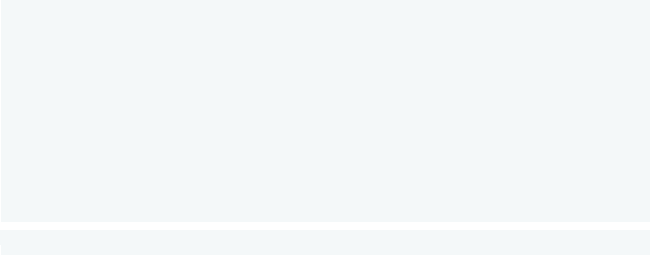
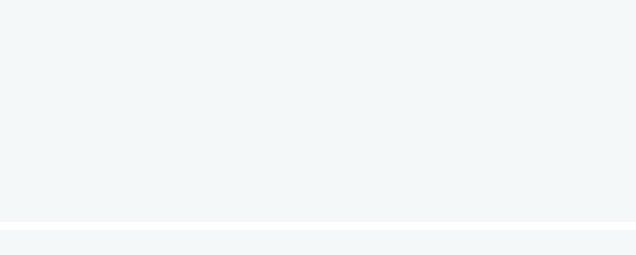
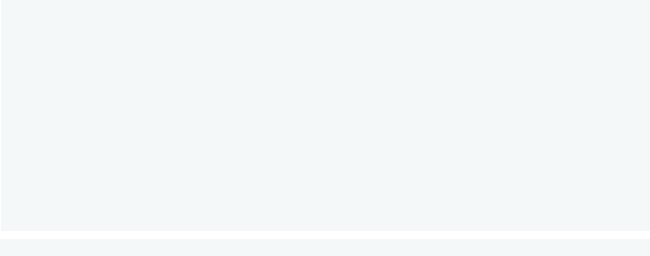



www.taoglas.com

