



WR-112 Standard Gain Horn with 20 dBi gain, N Female connector

Technical Data Sheet

PEWAN112-20NF

Mechanical Specifications

Size

Length	13.887 in [352.73 mm]
Width	5.487 in [139.37 mm]
Height	4.071 in [103.4 mm]
Weight	1.253 lbs [568.35 g]

RF Connector

Type	N Female
------	----------

Waveguide Interface

Waveguide Size	WR-112
----------------	--------

Environmental Specifications

Compliance Certifications (see [product page](#) for current document)

Plotted and Other Data

Notes:

Click the following link (or enter part number in "SEARCH" on website) to obtain additional part information including price, inventory and certifications: [WR-112 Standard Gain Horn with 20 dBi gain, N Female connector PEWAN112-20NF](#)



WR-112 Standard Gain Horn with 20 dBi gain, N Female connector

Technical Data Sheet

PEWAN112-20NF

Typical Performance Data

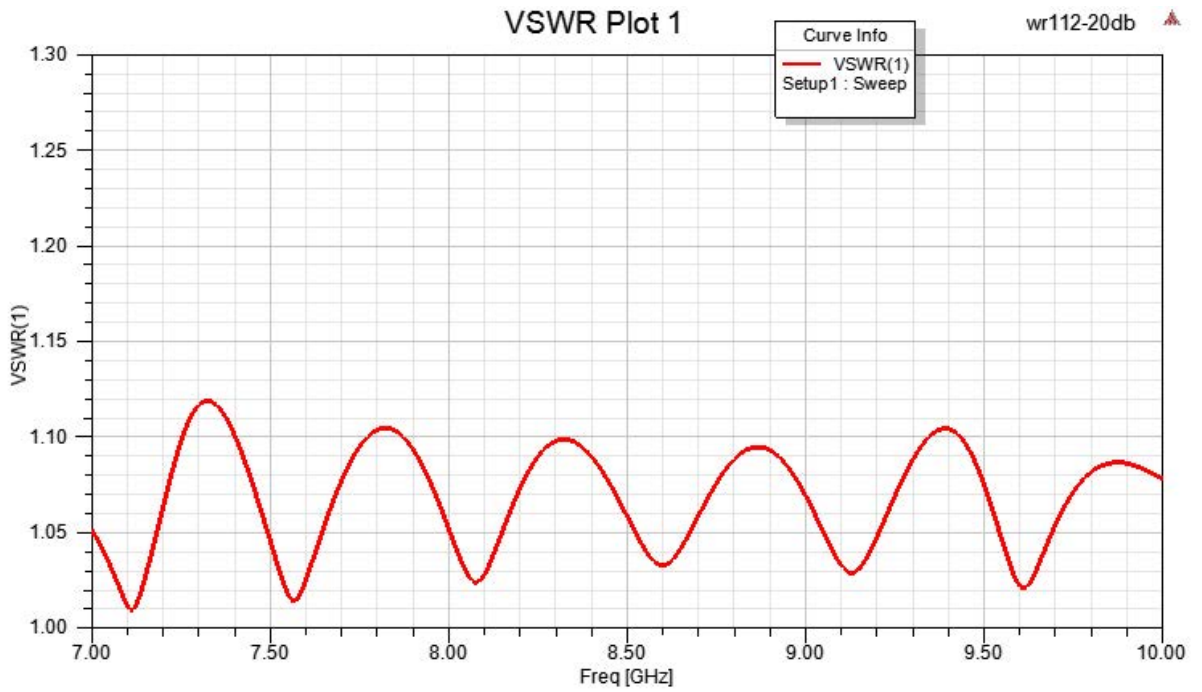

Click the following link (or enter part number in "SEARCH" on website) to obtain additional part information including price, inventory and certifications: [WR-112 Standard Gain Horn with 20 dBi gain, N Female connector PEWAN112-20NF](#)



WR-112 Standard Gain Horn with 20 dBi gain, N Female connector

Technical Data Sheet

PEWAN112-20NF

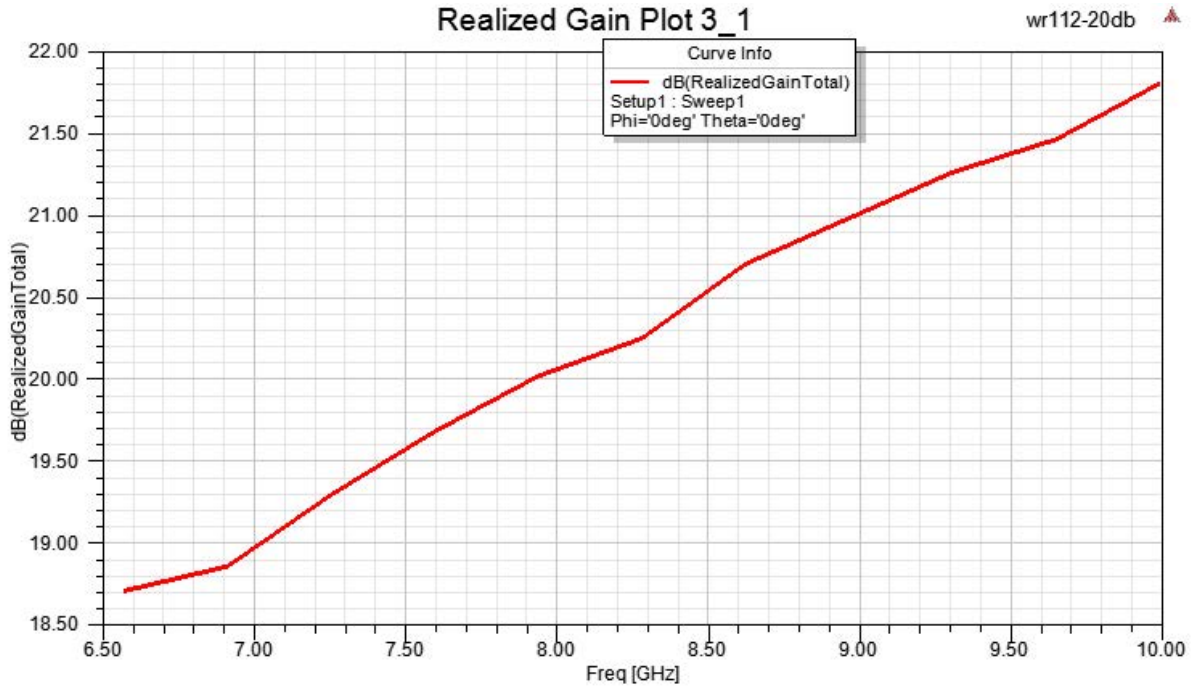

Click the following link (or enter part number in "SEARCH" on website) to obtain additional part information including price, inventory and certifications: [WR-112 Standard Gain Horn with 20 dBi gain, N Female connector PEWAN112-20NF](#)



WR-112 Standard Gain Horn with 20 dBi gain, N Female connector

Technical Data Sheet

PEWAN112-20NF

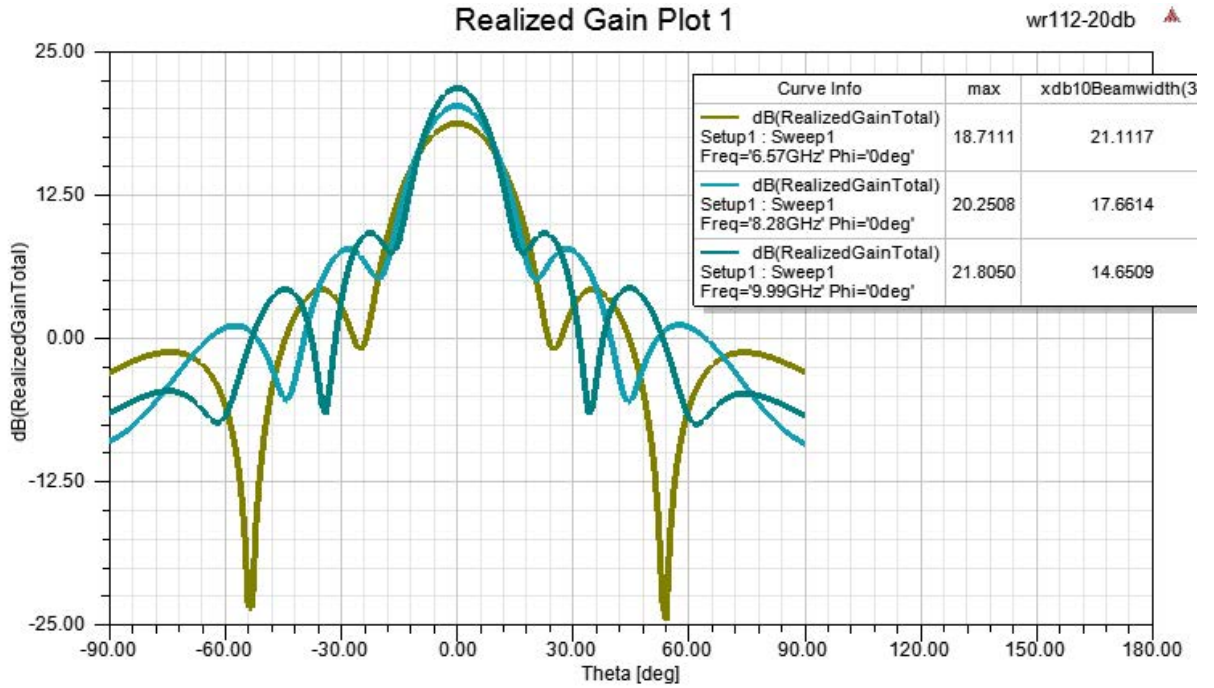

Click the following link (or enter part number in "SEARCH" on website) to obtain additional part information including price, inventory and certifications: [WR-112 Standard Gain Horn with 20 dBi gain, N Female connector PEWAN112-20NF](#)



WR-112 Standard Gain Horn with 20 dBi gain, N Female connector

Technical Data Sheet

PEWAN112-20NF

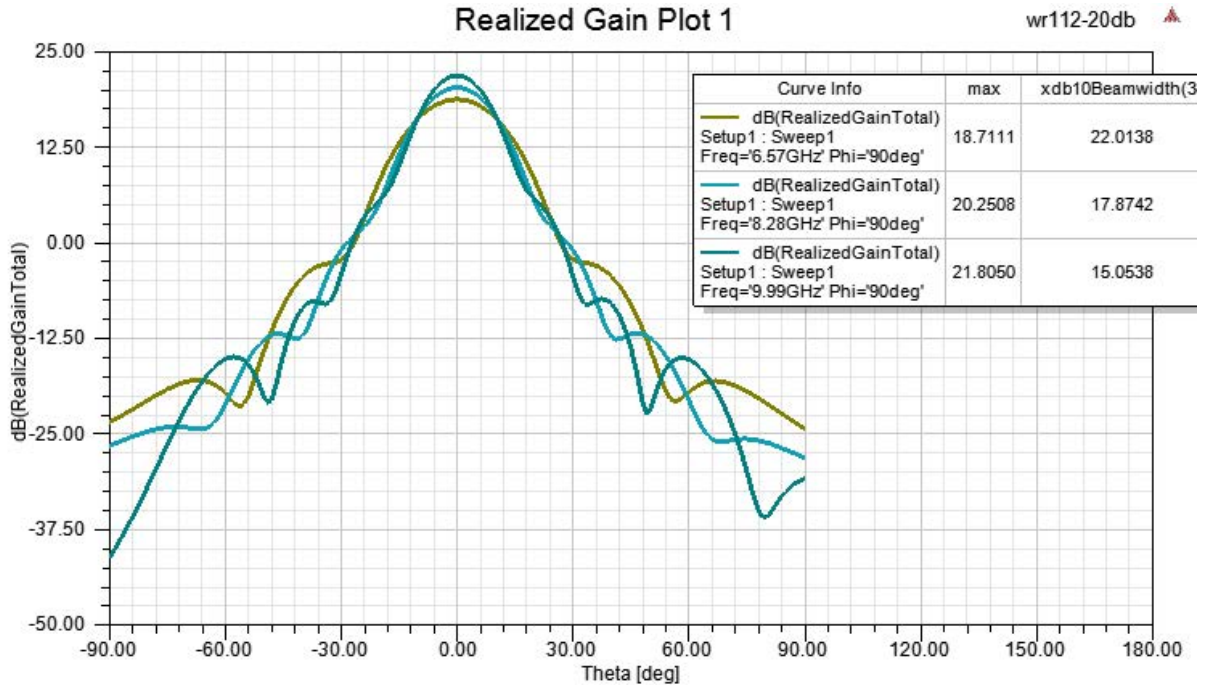

WR-112 Standard Gain Horn with 20 dBi gain, N Female connector from Pasternack Enterprises has same day shipment for domestic and International orders. Our RF, microwave and millimeter wave products maintain a 99.4% availability and are part of the broadest selection in the industry.

Click the following link (or enter part number in "SEARCH" on website) to obtain additional part information including price, inventory and certifications: [WR-112 Standard Gain Horn with 20 dBi gain, N Female connector PEWAN112-20NF](#)

URL:

The information contained in this document is accurate to the best of our knowledge and representative of the part described herein. It may be necessary to make modifications to the part and/or the documentation of the part, in order to implement improvements. Pasternack reserves the right to make such changes as required. Unless otherwise stated, all specifications are nominal. Pasternack does not make any representation or warranty regarding the suitability of the part described herein for any particular purpose, and Pasternack does not assume any liability arising out of the use of any part or documentation.

PEWAN112-20NF CAD Drawing

WR-112 Standard Gain Horn with 20 dBi gain, N Female connector

REVISIONS			
REV.	DESCRIPTION	DATE	APPROVED
A	INITIAL RELEASE	01/11/2022	KHIETPAS

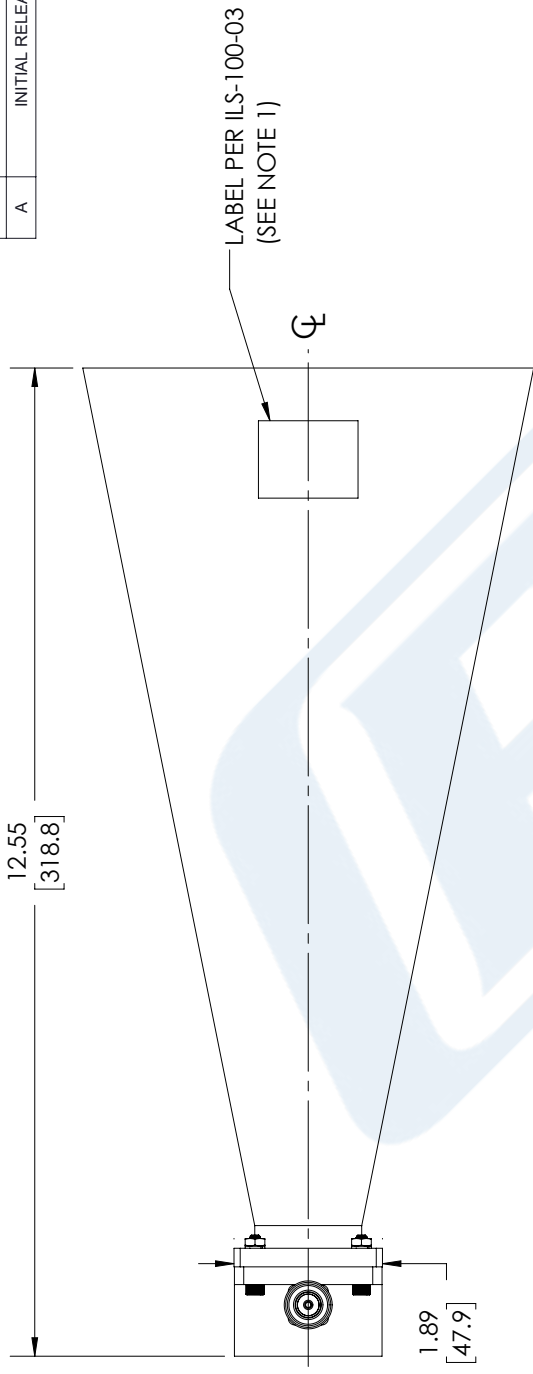

TYPE N FEMALE CONNECTOR

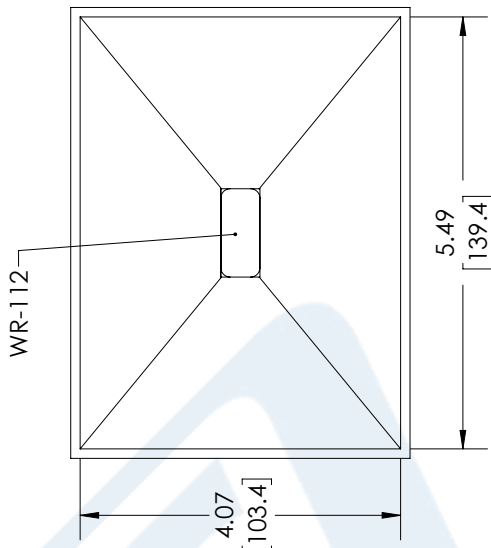
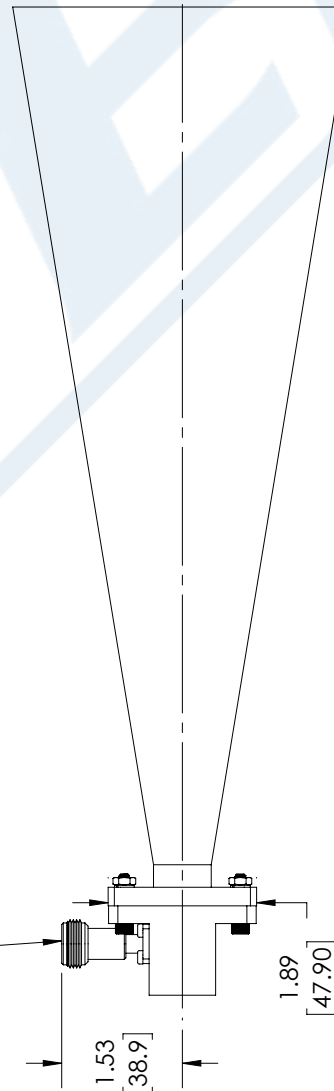

UNLESS OTHERWISE SPECIFIED LEADING DIMENSIONS ARE INCHES DIMENSIONS IN [] ARE MILLIMETERS

TOLERANCES:

.X = ±.2	[5.08]	FRACTIONS
.XX = ±.02	[.51]	± 1/32
.XXX = ±.005	[.13]	ANGLES ± 1°

CABLE LENGTH (L) TOLERANCES:

L ≤ 12	[305]	= +1 [25] / -0
12 [305] < L ≤ 60	[1524]	= +2 [51] / -0
60 [1524] < L ≤ 120	[3048]	= +4 [102] / -0
120 [3048] < L ≤ 300	[7620]	= +6 [152] / -0
300 [7620] < L		= +5%L / -0

ALL DIMENSIONS SHOWN ARE FOR REFERENCE ONLY.

THIRD-ANGLE PROJECTION

THE INFORMATION AND DESIGN IN THIS DOCUMENT IS THE PROPERTY OF PASTERNAK CORPORATION ALL RIGHTS RESERVED.

SHEET 1 OF 1

SCALE N/A

PE PASTERNAK
an INFINITE brand

Pasternack Enterprises, Inc.
P. O. Box 16759, Irvine, CA 92623.
Phone: 1.949.261.1920 | 1.866.727.8376
Fax: 1.949.261.7451
Website: www.pasternack.com
E-mail: sales@pasternack.com

ITEM NO. PEWAN112-20NF

SIZE	CAGE CODE	DRAWN BY	REV
A	53919	BPUCHASKI	A

- NOTES:**
- LABEL PER ILS-100-03 (FOR INTERNAL REFERENCE ONLY)
LABEL LOCATION FOR REFERENCE ONLY

THESE COMMODITIES, TECHNOLOGY OR SOFTWARE WERE EXPORTED FROM THE UNITED STATES IN ACCORDANCE WITH THE EXPORT ADMINISTRATION REGULATIONS. DIVERSION CONTRARY TO U.S. LAW PROHIBITED.