

2348771-1 ✓ ACTIVE

AMP | Heavy Duty Sealed Connector Series, MATEnet

TE Internal #: 2348771-1

Single Wire Seal (SWS), Silicone Rubber, White, 2.5 mm [.098 in]

Cavity Diameter, Heavy Duty Sealed Connector Series

[View on TE.com >](#)



Connectors > Connector Accessories > Connector Seals & Cavity Plugs

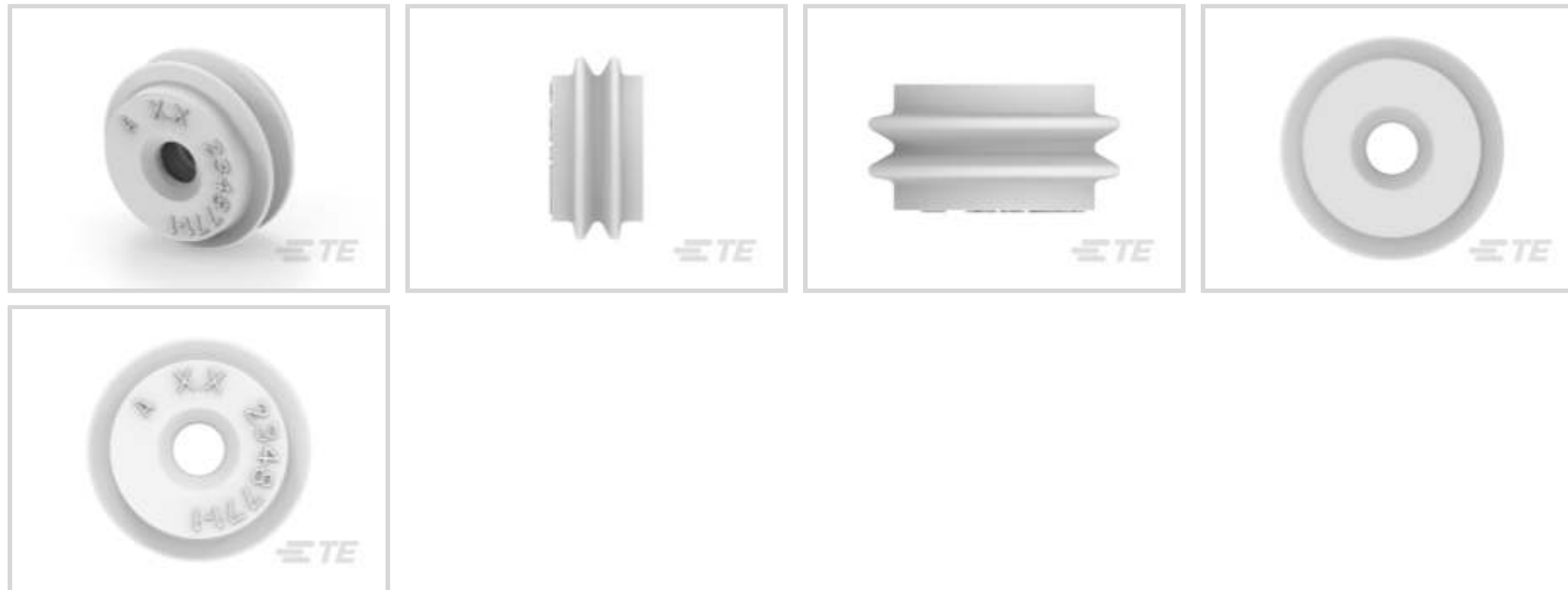

Connector Seal & Plug Type: **Single Wire Seal (SWS)**

Primary Product Material: **Silicone Rubber**

Primary Product Color: **White**

Cavity Diameter: **2.5 mm [.098 in]**

Compatible Insulation Diameter Range: **3.1 – 4.9 mm [.122 – .193 in]**

Features

Product Type Features

Connector Seal & Plug Type	Single Wire Seal (SWS)
----------------------------	------------------------

Body Features

Primary Product Material	Silicone Rubber
--------------------------	-----------------

Primary Product Color	White
-----------------------	-------

Dimensions

Cavity Diameter	2.5 mm [.098 in]
-----------------	------------------

Compatible Insulation Diameter Range	3.1 – 4.9 mm [.122 – .193 in]
--------------------------------------	-------------------------------

Usage Conditions

Operating Temperature (Max)	125 °C [257 °F]
-----------------------------	-----------------

Operating Temperature Range	-40 – 125 °C [-40 – 257 °F]
-----------------------------	-----------------------------

Other

Shore A Hardness	50
------------------	----

Contains Lubricant	Yes
--------------------	-----



Product Compliance

[For compliance documentation, visit the product page on TE.com>](#)

EU RoHS Directive 2011/65/EU	Compliant
EU ELV Directive 2000/53/EC	Compliant
China RoHS 2 Directive MIIT Order No 32, 2016	No Restricted Materials Above Threshold
EU REACH Regulation (EC) No. 1907/2006	Current ECHA Candidate List: JUNE 2023 (235) Candidate List Declared Against: JUNE 2023 (235) Does not contain REACH SVHC
Halogen Content	BFR/CFR/PVC Free, but Br/Cl >900 ppm in other sources.
Solder Process Capability	Not reviewed for solder process capability

Product Compliance Disclaimer

This information is provided based on reasonable inquiry of our suppliers and represents our current actual knowledge based on the information they provided. This information is subject to change. The part numbers that TE has identified as EU RoHS compliant have a maximum concentration of 0.1% by weight in homogenous materials for lead, hexavalent chromium, mercury, PBB, PBDE, DBP, BBP, DEHP, DIBP, and 0.01% for cadmium, or qualify for an exemption to these limits as defined in the Annexes of Directive 2011/65/EU (RoHS2). Finished electrical and electronic equipment products will be CE marked as required by Directive 2011/65/EU. Components may not be CE marked. Additionally, the part numbers that TE has identified as EU ELV compliant have a maximum concentration of 0.1% by weight in homogenous materials for lead, hexavalent chromium, and mercury, and 0.01% for cadmium, or qualify for an exemption to these limits as defined in the Annexes of Directive 2000/53/EC (ELV). Regarding the REACH Regulation, the information TE provides on SVHC in articles for this part number is based on the latest European Chemicals Agency (ECHA) 'Guidance on requirements for substances in articles' posted at this URL: <https://echa.europa.eu/guidance-documents/guidance-on-reach>

Compatible Parts

 <p>TE Part # 9-2348772-1 HD MATEnet 3+0 TAB HSG ASSY, GRP E</p>	 <p>TE Part # 9-2348772-2 HD MATEnet 3+0 TAB HSG ASSY, GRP E</p>	 <p>TE Part # 9-2348776-1 HD MATEnet 3+0 REC HSG ASSY, GRP E</p>	 <p>TE Part # 9-2348776-2 HD MATEnet 3+0 REC HSG ASSY, GRP E</p>
 <p>TE Part # 9-2348782-1 HD MATEnet 2+6 TAB HSG ASSY, GRP E</p>	 <p>TE Part # 9-2348782-2 HD MATEnet 2+6 TAB HSG ASSY, GRP E</p>	 <p>TE Part # 9-2348786-1 HD MATEnet 2+6 REC HSG ASSY, GRP E</p>	 <p>TE Part # 9-2348786-2 HD MATEnet 2+6 REC HSG ASSY, GRP E</p>

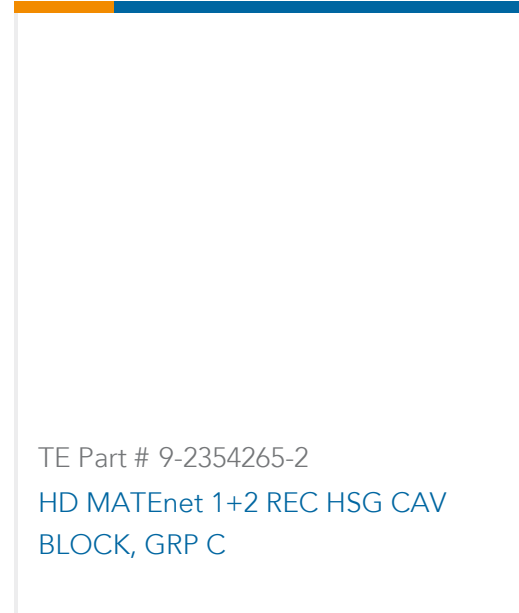
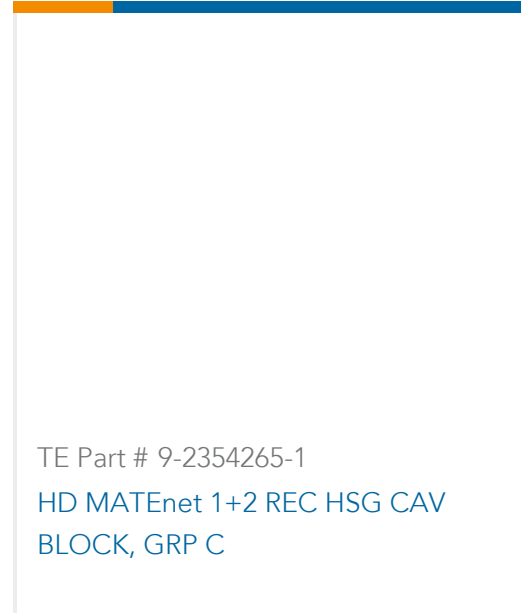

Also in the Series | **Heavy Duty Sealed Connector Series**

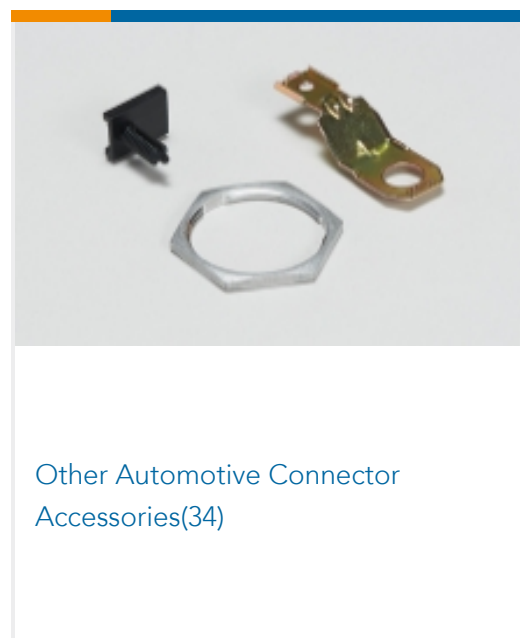
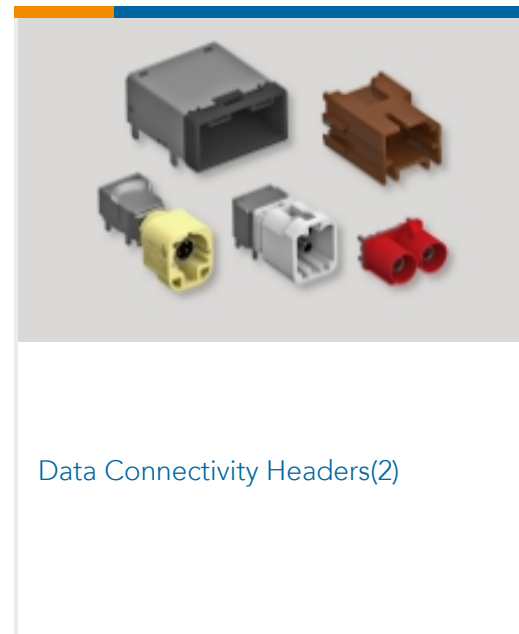
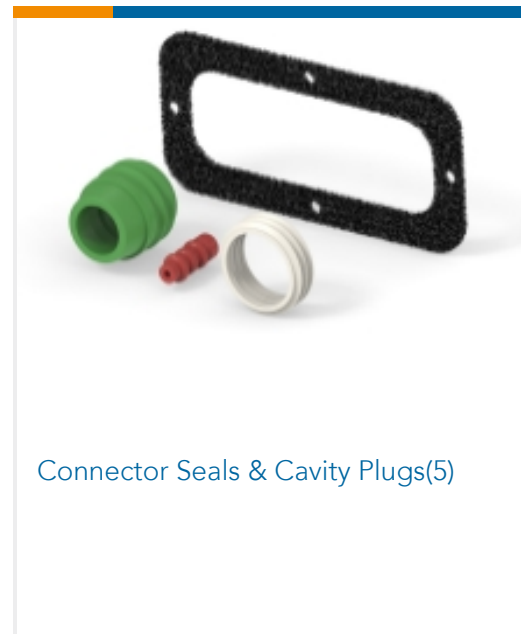
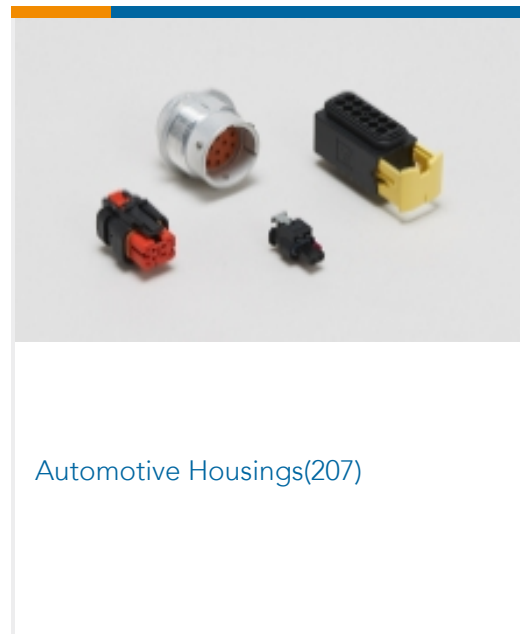
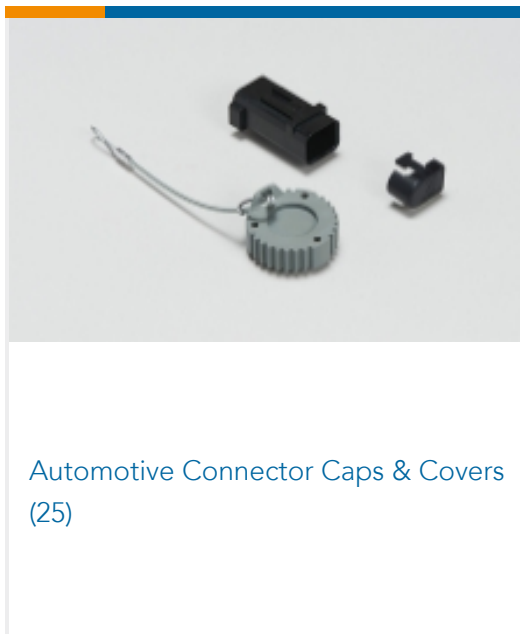

Also in the Series | **MATEnet**



Automotive Connector Caps & Covers (5)

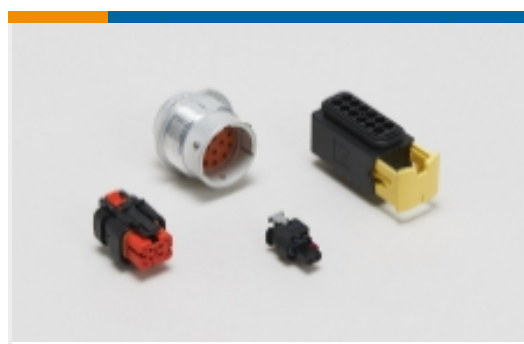

Automotive Housings(1)



Connector Seals & Cavity Plugs(5)



Data Connectivity Headers(7)



Data Connectivity Housings(31)



Other Automotive Connector Accessories(1)

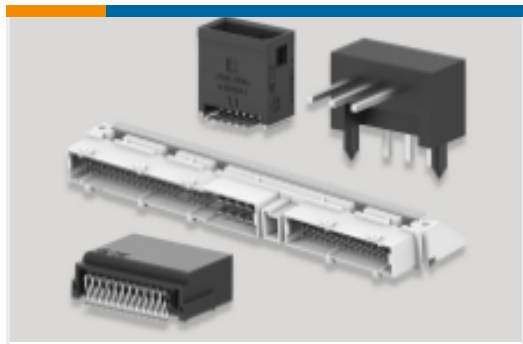

PCB Headers & Receptacles(2)

Customers Also Bought

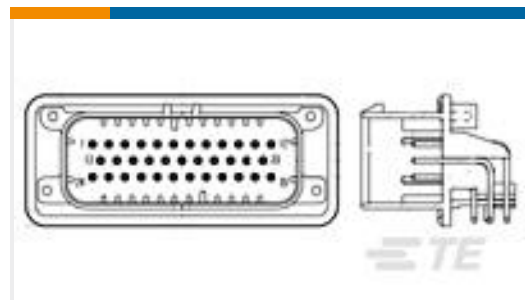

TE Part #1-776180-6
35POS,AMPSEAL,PIN HSG ASSY,SLD, COD 6



TE Part #1-2141324-1
6POS, MCON 1.2 LL TAB SEALED COD A



TE Part #1-1670919-1
6POS, MCON 1.2 LL REC SEALED



TE Part #2098198-5
Plug Assembly, Sealed, 1 Posn,



TE Part #1564324-3
AMP MCP 1.5K, CONTACT, SWS



TE Part #1-2344950-1
95POS, HYBRID, REC HSG, ASSY, COD A



TE Part #2-2344950-1
95POS, HYBRID, REC HSG, ASSY, COD B



TE Part #2327845-1
95POS, MCON 1.2, SECONDARY LOCKING



TE Part #2405341-1
BLIND PLUG BLOCK ASSMBLY, FINGER UNLOCK.



TE Part #2407666-1
BLIND PLUG BLOCK ASSEMBLY, FINGER UNLOCK

Documents



Product Drawings

HD MATEnet SWS

English

HD MATEnet SWS

English

CAD Files

3D PDF

3D

Customer View Model

[ENG_CVM_CVM_2348771-1_A.2d_dxf.zip](#)

English

Customer View Model

[ENG_CVM_CVM_2348771-1_A.3d_igs.zip](#)

English

Customer View Model

[ENG_CVM_CVM_2348771-1_A.3d_stp.zip](#)

English

By downloading the CAD file I accept and agree to the [Terms and Conditions](#) of use.

Product Specifications

Application Specification

English