

Heterojunction Bipolar Transistor (InGaP HBT)

Broadband High Linearity Amplifier

The MMG3009NT1 is a general purpose amplifier that is internally input and output matched. It is designed for a broad range of Class A, small-signal, high linearity, general purpose applications. It is suitable for applications with frequencies from 0 to 6000 MHz such as cellular, PCS, BWA, WLL, PHS, CATV, VHF, UHF, UMTS and general small-signal RF.

Features

- Frequency: 0 to 6000 MHz
- P1dB: 18 dBm @ 900 MHz
- Small-Signal Gain: 15 dB @ 900 MHz
- Third Order Output Intercept Point: 34 dBm @ 900 MHz
- Single 5 V Supply
- Internally Matched to 50 Ohms
- Cost-effective SOT-89 Surface Mount Plastic Package
- In Tape and Reel. T1 Suffix = 1,000 Units, 12 mm Tape Width, 7-inch Reel.

MMG3009NT1

**0-6000 MHz, 15 dB
 18 dBm
 InGaP HBT GPA**



SOT-89

Table 1. Typical Performance (1)

Characteristic	Symbol	900 MHz	2140 MHz	3500 MHz	Unit
Small-Signal Gain (S21)	G_p	15	14	12.5	dB
Input Return Loss (S11)	IRL	-13	-26	-22	dB
Output Return Loss (S22)	ORL	-17	-15	-24	dB
Power Output @1dB Compression	P1dB	18	18	17.5	dBm
Third Order Output Intercept Point	OIP3	34	32	31	dBm

1. $V_{CC} = 5$ Vdc, $T_A = 25^\circ\text{C}$, 50 ohm system.

Table 2. Maximum Ratings

Rating	Symbol	Value	Unit
Supply Voltage	V_{CC}	7	V
Supply Current	I_{CC}	300	mA
RF Input Power	P_{in}	10	dBm
Storage Temperature Range	T_{stg}	-65 to +150	$^\circ\text{C}$
Junction Temperature	T_J	150	$^\circ\text{C}$

Table 3. Thermal Characteristics

Characteristic	Symbol	Value (2)	Unit
Thermal Resistance, Junction to Case Case Temperature 88 $^\circ\text{C}$, 5 Vdc, 70 mA, no RF applied	$R_{\theta JC}$	81	$^\circ\text{C/W}$

2. Refer to AN1955, *Thermal Measurement Methodology of RF Power Amplifiers*. Go to <http://www.freescale.com/rf>.
 Select Documentation/Application Notes - AN1955.

LIFETIME BUY

LAST SHIP 24 MAY 15
 LAST ORDER 24 MAY 14

Table 4. Electrical Characteristics ($V_{CC} = 5 \text{ Vdc}$, 900 MHz, $T_A = 25^\circ\text{C}$, 50 ohm system, in Freescale Application Circuit)

Characteristic	Symbol	Min	Typ	Max	Unit
Small-Signal Gain (S21)	G_p	14.3	15	—	dB
Input Return Loss (S11)	IRL	—	-13	—	dB
Output Return Loss (S22)	ORL	—	-17	—	dB
Power Output @ 1dB Compression	P1dB	—	18	—	dBm
Third Order Output Intercept Point	OIP3	—	34	—	dBm
Noise Figure	NF	—	4.2	—	dB
Supply Current	I_{CC}	58	70	82	mA
Supply Voltage	V_{CC}	—	5	—	V

Table 5. Functional Pin Description

Pin Number	Pin Function
1	RF_{in}
2	Ground
3	RF_{out}/DC Supply

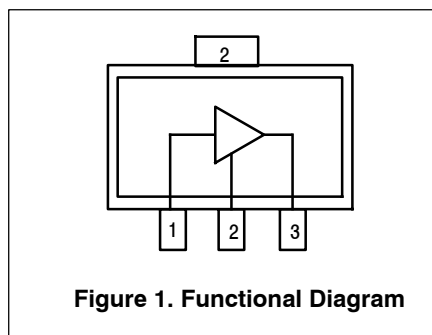

Figure 1. Functional Diagram

Table 6. ESD Protection Characteristics

Test Methodology	Class
Human Body Model (per JESD 22-A114)	1A
Machine Model (per EIA/JESD 22-A115)	A
Charge Device Model (per JESD 22-C101)	IV

Table 7. Moisture Sensitivity Level

Test Methodology	Rating	Package Peak Temperature	Unit
Per JESD 22-A113, IPC/JEDEC J-STD-020	1	260	$^\circ\text{C}$

LIFETIME BUY

LAST ORDER 24 MAY 14 LAST SHIP 24 MAY 15

50 OHM TYPICAL CHARACTERISTICS

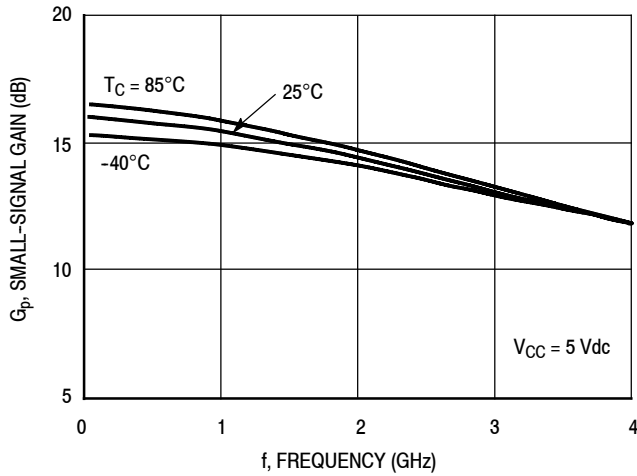

Figure 2. Small-Signal Gain (S21) versus Frequency

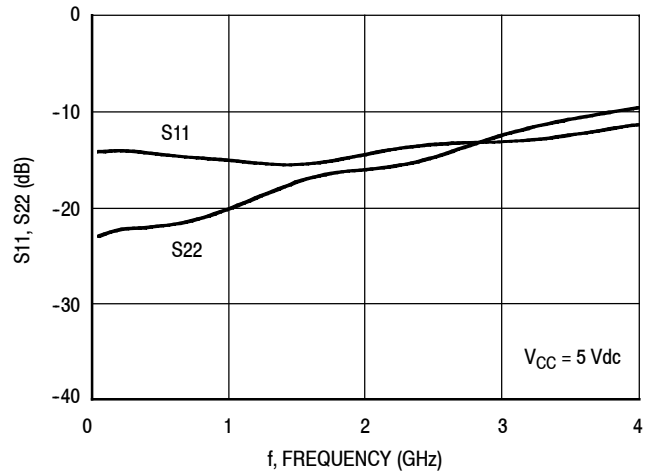

Figure 3. Input/Output Return Loss versus Frequency

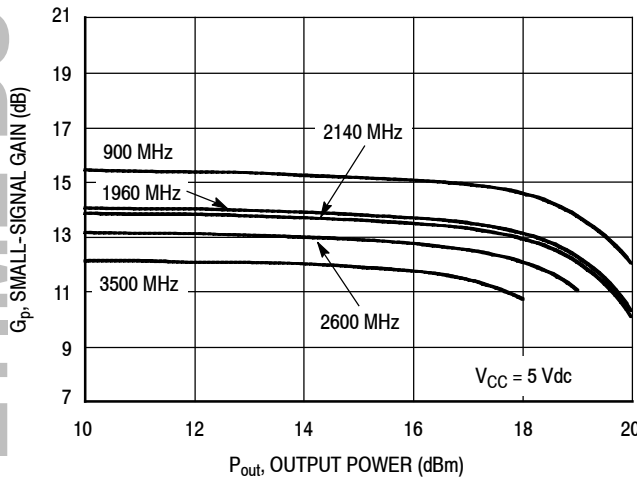

Figure 4. Small-Signal Gain versus Output Power

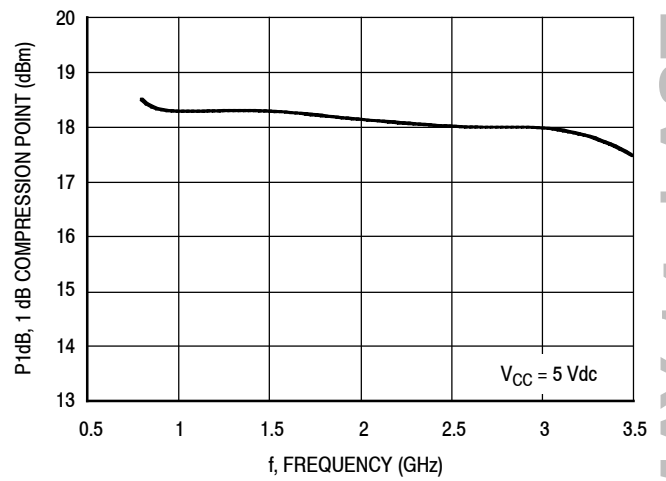

Figure 5. P1dB versus Frequency

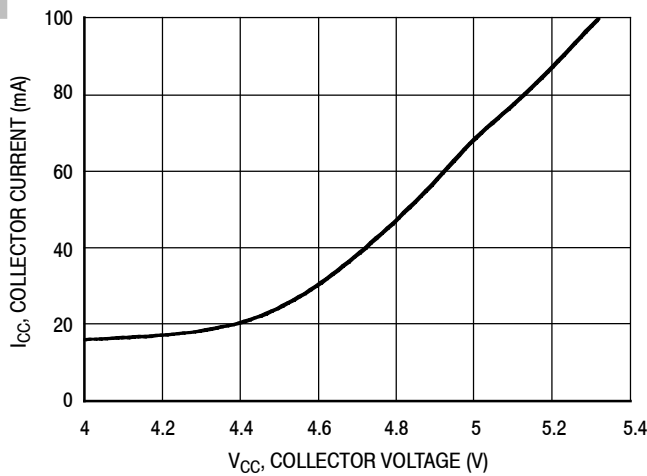

Figure 6. Collector Current versus Collector Voltage

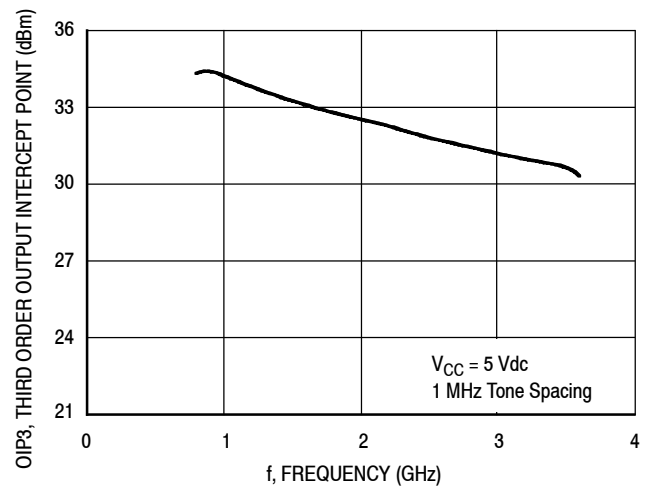

Figure 7. Third Order Output Intercept Point versus Frequency

LIFETIME BUY

LAST ORDER 24 MAY 14 LAST SHIP 24 MAY 15

50 OHM TYPICAL CHARACTERISTICS

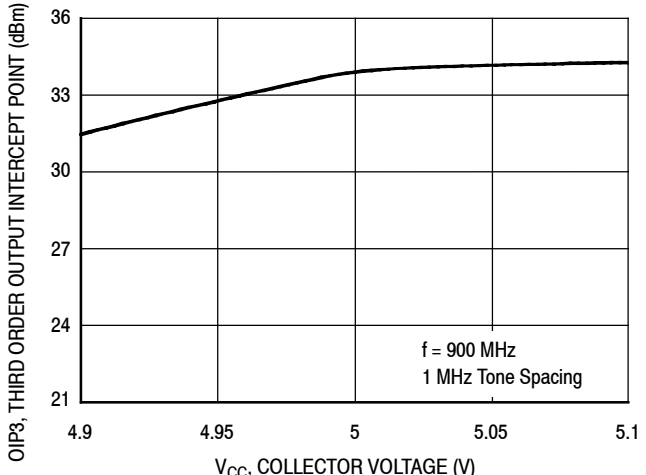

Figure 8. Third Order Output Intercept Point versus Collector Voltage

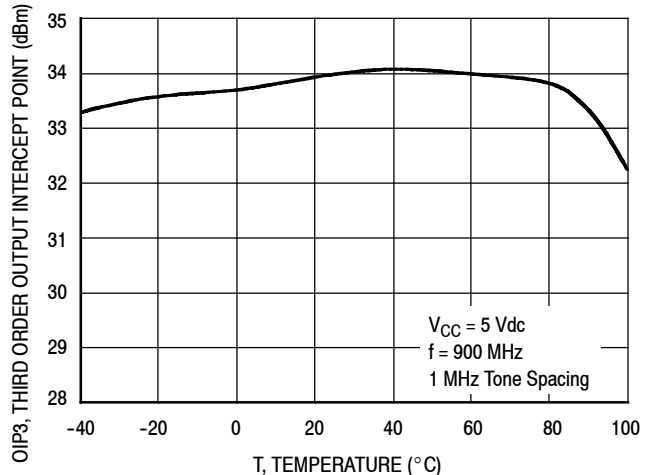

Figure 9. Third Order Output Intercept Point versus Case Temperature

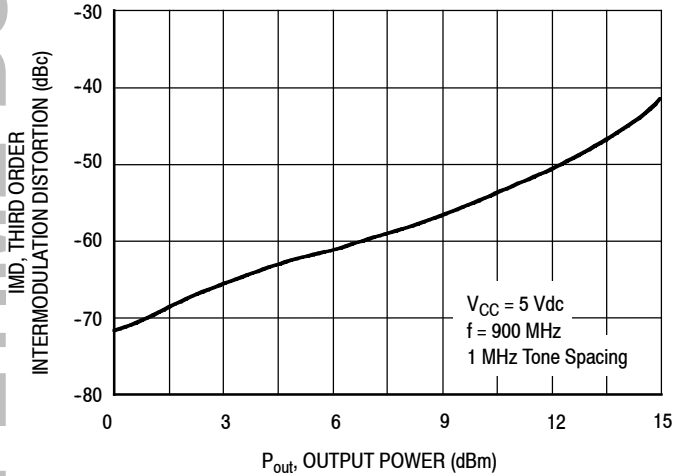

Figure 10. Third Order Intermodulation Distortion versus Output Power

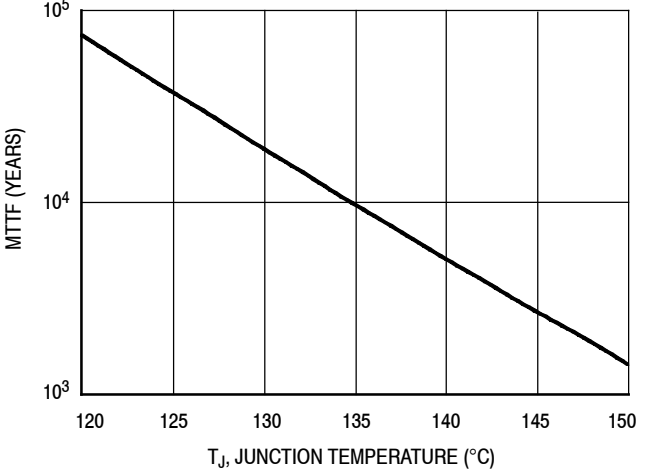

Figure 11. MTTF versus Junction Temperature
NOTE: The MTTF is calculated with $V_{CC} = 5 \text{ Vdc}$, $I_{CC} = 70 \text{ mA}$

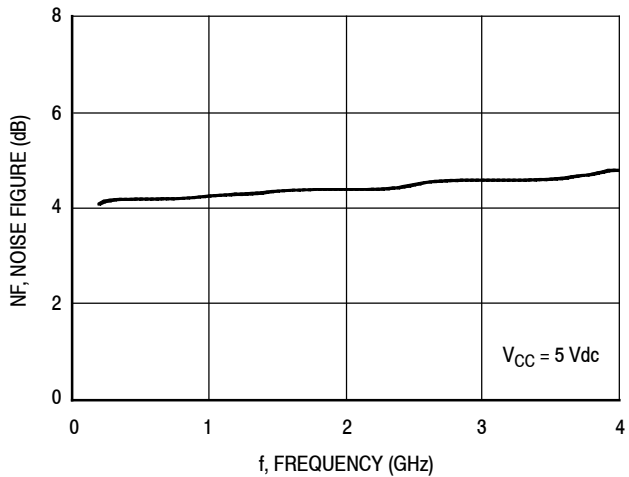

Figure 12. Noise Figure versus Frequency

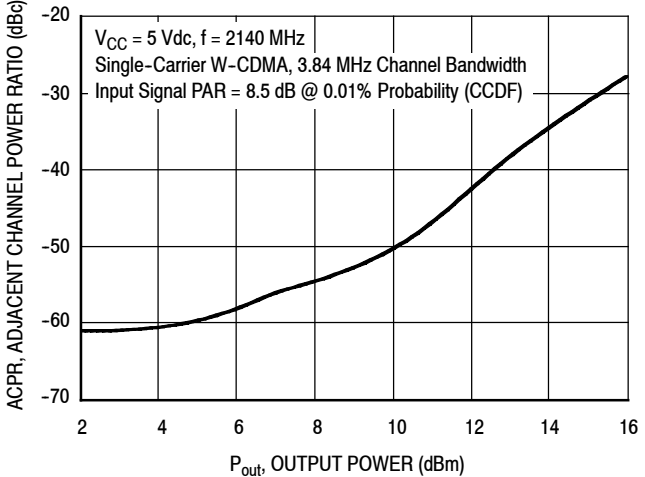

Figure 13. Single-Carrier W-CDMA Adjacent Channel Power Ratio versus Output Power

LIFETIME BUY

LAST ORDER 24 MAY 14 LAST SHIP 24 MAY 15

50 OHM APPLICATION CIRCUIT: 40-300 MHz

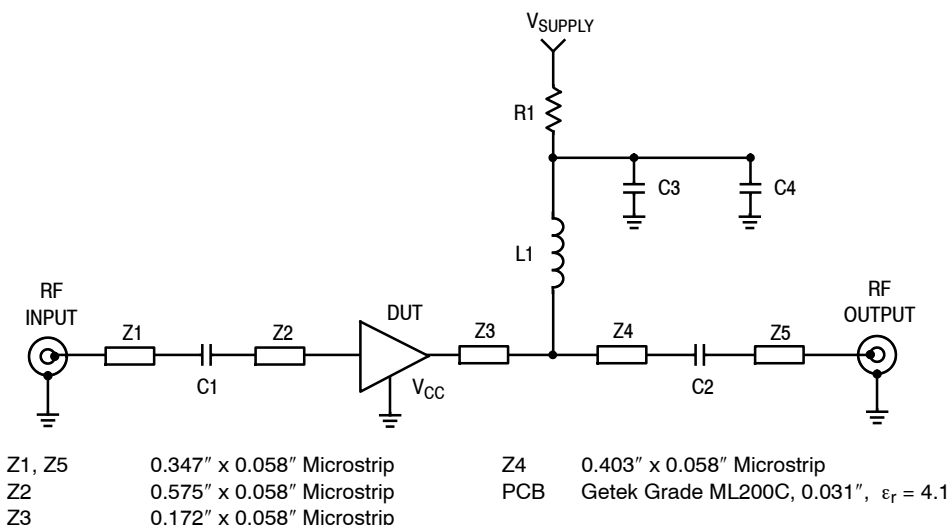

Figure 14. 50 Ohm Test Circuit Schematic

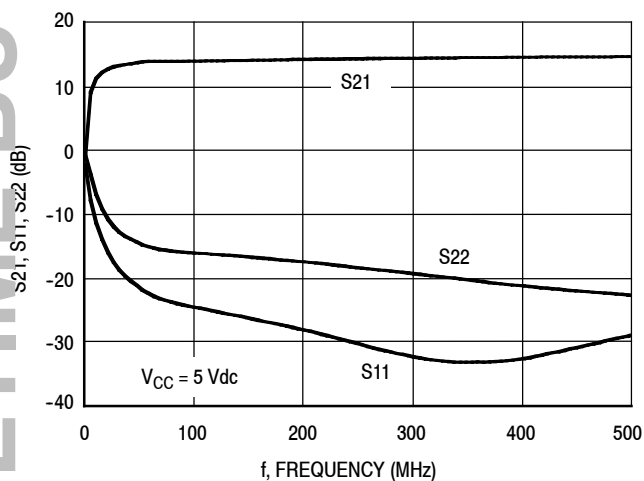

Figure 15. S21, S11 and S22 versus Frequency

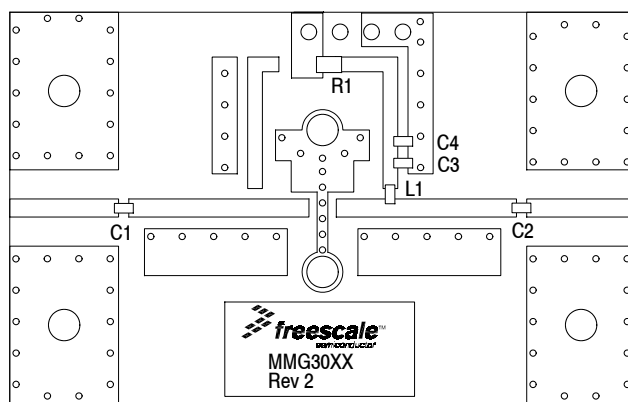

Figure 16. 50 Ohm Test Circuit Component Layout

Table 8. 50 Ohm Test Circuit Component Designations and Values

Part	Description	Part Number	Manufacturer
C1, C2, C3	0.01 μ F Chip Capacitors	C0603C103J5RAC	Kemet
C4	1000 pF Chip Capacitor	C0603C102J5RAC	Kemet
L1	470 nH Chip Inductor	BK2125HM471-T	Taiyo Yuden
R1	0 Ω Chip Resistor	ERJ3GEY0R00V	Panasonic

LIFETIME BUY

LAST ORDER 24 MAY 14 LAST SHIP 24 MAY 15

50 OHM APPLICATION CIRCUIT: 300-3600 MHz

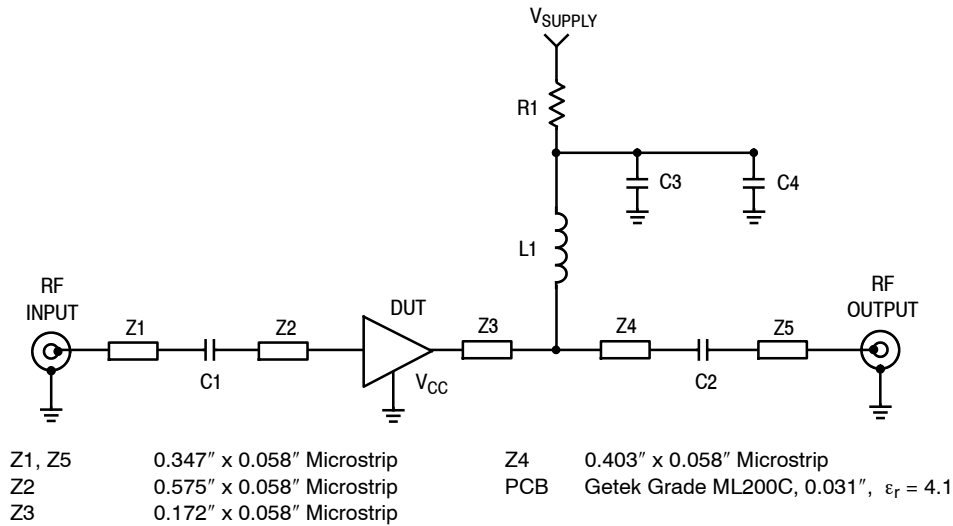

Figure 17. 50 Ohm Test Circuit Schematic

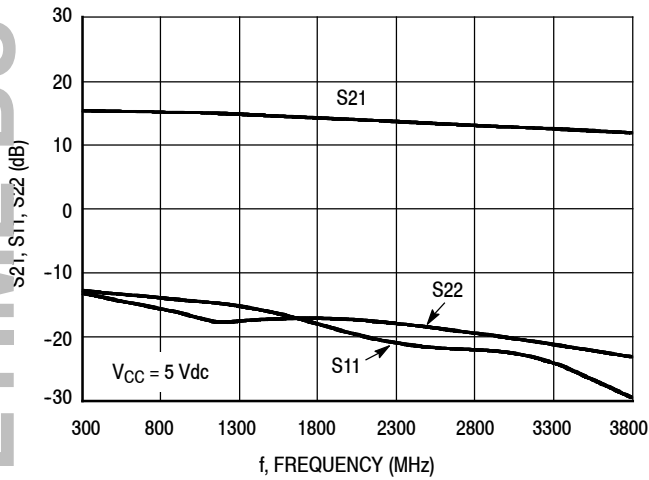

Figure 18. S21, S11 and S22 versus Frequency

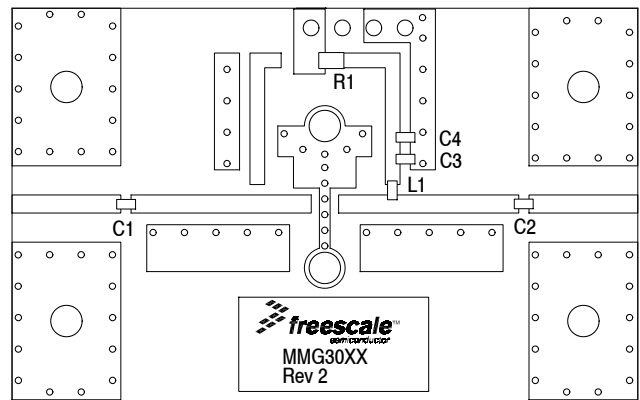

Figure 19. 50 Ohm Test Circuit Component Layout

Table 9. 50 Ohm Test Circuit Component Designations and Values

Part	Description	Part Number	Manufacturer
C1, C2	150 pF Chip Capacitors	C0603C151J5RAC	Kemet
C3	0.01 μ F Chip Capacitor	C0603C103J5RAC	Kemet
C4	1000 pF Chip Capacitor	C0603C102J5RAC	Kemet
L1	56 nH Chip Inductor	HK160856NJ-T	Taiyo Yuden
R1	0 Ω Chip Resistor	ERJ3GEY0R00V	Panasonic

50 OHM TYPICAL CHARACTERISTICS

Table 10. Common Emitter S-Parameters ($V_{CC} = 5 \text{ Vdc}$, $T_A = 25^\circ\text{C}$, 50 Ohm System)

f MHz	S ₁₁		S ₂₁		S ₁₂		S ₂₂	
	S ₁₁	∠ φ	S ₂₁	∠ φ	S ₁₂	∠ φ	S ₂₂	∠ φ
100	0.19606	-174.964	6.33492	175.897	0.10115	-0.614	0.07282	176.529
150	0.19734	-176.357	6.30368	173.26	0.10204	-1.587	0.07571	178.062
200	0.19944	169.849	6.27983	171.036	0.10220	-2.173	0.07648	-178.213
250	0.20027	168.421	6.24623	169.018	0.10243	-2.498	0.08038	-175.337
300	0.19924	166.435	6.22884	166.867	0.10334	-2.998	0.07928	-172.371
350	0.19543	164.497	6.22675	164.532	0.10364	-3.636	0.07836	-172.028
400	0.19419	162.266	6.21021	162.42	0.10357	-4.18	0.07876	-169.383
450	0.19172	160.135	6.19495	160.278	0.10351	-4.669	0.07882	-167.245
500	0.18914	158.072	6.18191	158.065	0.10361	-5.256	0.07903	-165.903
550	0.18788	156.056	6.16313	155.935	0.10378	-5.746	0.07946	-164.125
600	0.18596	154.01	6.14591	153.778	0.10379	-6.277	0.08061	-162.978
650	0.18399	152.064	6.12734	151.629	0.10396	-6.756	0.08181	-162.118
700	0.18285	150.008	6.10486	149.511	0.10408	-7.313	0.08346	-161.229
750	0.18159	148.088	6.08449	147.384	0.10411	-7.817	0.08496	-160.812
800	0.18056	146.09	6.06038	145.27	0.10427	-8.376	0.08717	-160.896
850	0.17973	144.286	6.03306	143.153	0.10440	-8.885	0.08917	-161.031
900	0.17932	142.485	6.00923	141.039	0.10453	-9.38	0.09202	-161.574
950	0.17920	140.759	5.98147	138.952	0.10467	-9.995	0.09484	-162.293
1000	0.17847	139.226	5.95646	136.927	0.10485	-10.462	0.09809	-163.293
1050	0.17754	137.531	5.92809	134.838	0.10508	-11.017	0.10057	-164.366
1100	0.17453	136.047	5.89423	132.763	0.10519	-11.541	0.10471	-165.489
1150	0.17205	134.871	5.86296	130.716	0.10534	-12.012	0.10843	-167.229
1200	0.17066	133.54	5.83017	128.685	0.10542	-12.612	0.11227	-168.9
1250	0.16951	132.305	5.79633	126.662	0.10564	-13.155	0.11601	-170.51
1300	0.16662	131.182	5.76557	124.647	0.10580	-13.654	0.12012	-172.32
1350	0.16577	130.038	5.73189	122.631	0.10602	-14.194	0.12430	-174.175
1400	0.16504	128.988	5.69605	120.653	0.10620	-14.728	0.12842	-176.041
1450	0.16426	128.206	5.65985	118.678	0.10641	-15.283	0.13238	-178.197
1500	0.16609	122.177	5.63288	116.712	0.10680	-15.856	0.13929	-178.349
1550	0.16661	120.535	5.60045	114.805	0.10706	-16.422	0.14264	179.292
1600	0.16797	118.895	5.56701	112.889	0.10732	-16.914	0.14623	176.482
1650	0.17042	117.389	5.53367	110.947	0.10761	-17.529	0.14778	174.032
1700	0.17177	116.114	5.50453	109.079	0.10790	-18.111	0.15034	171.358
1750	0.17361	114.897	5.47270	107.137	0.10818	-18.625	0.15223	168.855
1800	0.17663	113.75	5.43993	105.194	0.10841	-19.165	0.15382	166.27
1850	0.17969	112.634	5.40358	103.282	0.10863	-19.761	0.15575	163.924
1900	0.18333	111.562	5.36970	101.431	0.10919	-20.39	0.15708	161.656
1950	0.18634	110.534	5.33711	99.484	0.10950	-21.017	0.15722	159.517
2000	0.18991	109.707	5.30347	97.624	0.10980	-21.621	0.15781	157.67
2050	0.19272	108.497	5.26942	95.722	0.11012	-22.222	0.15859	156.162
2100	0.19593	107.602	5.23491	93.803	0.11037	-22.899	0.15951	154.73
2150	0.19925	106.721	5.19782	91.865	0.11076	-23.629	0.16086	153.761
2200	0.20272	105.922	5.15894	89.97	0.11107	-24.273	0.16242	152.923
2250	0.20521	104.933	5.11750	88.119	0.11132	-24.939	0.16412	151.958

(continued)

MMG3009NT1

LIFETIME BUY

LAST ORDER 24 MAY 14 LAST SHIP 24 MAY 15

50 OHM TYPICAL CHARACTERISTICS

Table 10. Common Emitter S-Parameters ($V_{CC} = 5 \text{ Vdc}$, $T_A = 25^\circ\text{C}$, 50 Ohm System) (continued)

f MHz	S ₁₁		S ₂₁		S ₁₂		S ₂₂	
	S ₁₁	∠ φ	S ₂₁	∠ φ	S ₁₂	∠ φ	S ₂₂	∠ φ
2300	0.20819	103.761	5.07836	86.232	0.11160	-25.64	0.16622	151.355
2350	0.21027	102.506	5.03981	84.384	0.11177	-26.346	0.16892	150.63
2400	0.21179	101.509	4.99976	82.526	0.11206	-26.995	0.17307	150.179
2450	0.21372	100.321	4.95674	80.649	0.11219	-27.627	0.17696	149.454
2500	0.21503	99.084	4.91517	78.813	0.11247	-28.368	0.18136	148.699
2550	0.21607	98.079	4.87557	77.083	0.11260	-29.056	0.18649	147.675
2600	0.21693	96.937	4.83415	75.317	0.11290	-29.737	0.19209	146.671
2650	0.21764	95.679	4.79330	73.409	0.11315	-30.261	0.19800	145.149
2700	0.21800	94.585	4.75322	71.62	0.11317	-31.061	0.20392	144.12
2750	0.21817	93.428	4.71387	69.917	0.11349	-31.733	0.20970	142.804
2800	0.21833	92.207	4.67702	68.159	0.11366	-32.454	0.21628	141.065
2850	0.21805	91.061	4.63817	66.317	0.11402	-33.132	0.22172	139.329
2900	0.21865	89.888	4.60218	64.555	0.11435	-33.832	0.22856	137.508
2950	0.21925	88.748	4.56625	62.873	0.11463	-34.552	0.23450	135.667
3000	0.21915	87.532	4.53210	61.144	0.11512	-35.281	0.24044	133.457
3050	0.22110	86.342	4.50064	59.382	0.11540	-36.033	0.24561	131.639
3100	0.22166	85.246	4.46608	57.613	0.11582	-36.792	0.25129	129.229
3150	0.22283	84.227	4.43647	55.954	0.11604	-37.437	0.25625	127.153
3200	0.22458	83.152	4.40552	54.104	0.11651	-38.235	0.26146	124.84
3250	0.22637	82.137	4.37427	52.337	0.11696	-38.955	0.26652	122.578
3300	0.22771	81.039	4.34455	50.582	0.11740	-39.776	0.27125	120.071
3350	0.23010	79.979	4.31085	48.824	0.11778	-40.645	0.27548	118.04
3400	0.23244	78.98	4.28183	47.09	0.11825	-41.441	0.28049	115.642
3450	0.23531	78.054	4.25137	45.379	0.11856	-42.323	0.28504	113.247
3500	0.23838	77.028	4.22125	43.528	0.11892	-43.156	0.28907	111.227
3550	0.24191	76.08	4.19033	41.795	0.11931	-43.953	0.29393	108.97
3600	0.24470	75.139	4.15822	40.059	0.11966	-44.868	0.29797	106.843

LIFETIME BUY

LAST ORDER 24 MAY 14 LAST SHIP 24 MAY 15

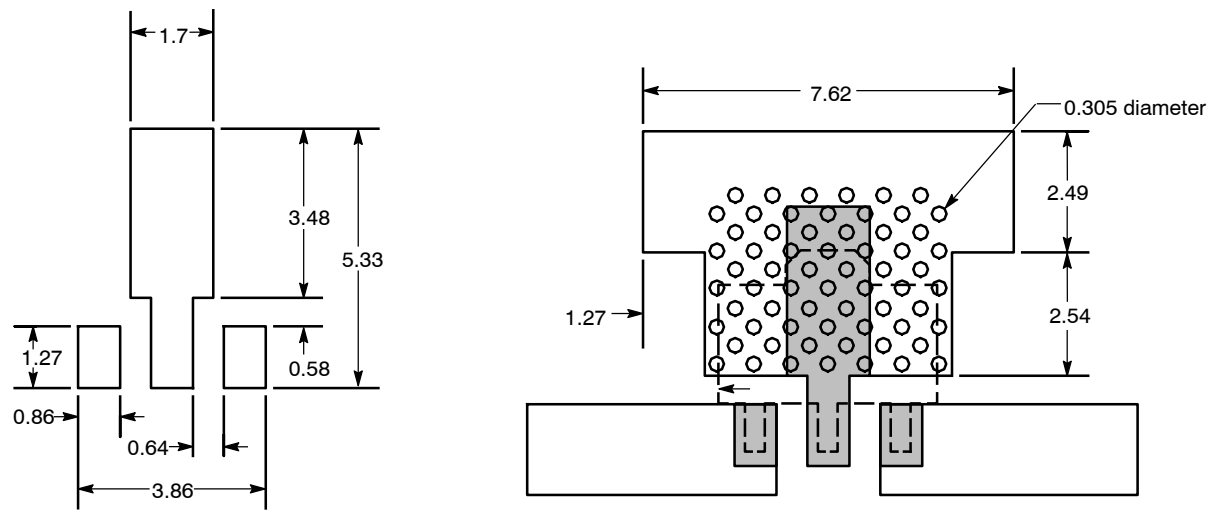

Recommended Solder Stencil

- NOTES:
1. THERMAL AND RF GROUNDING CONSIDERATIONS SHOULD BE USED IN PCB LAYOUT DESIGN.
 2. DEPENDING ON PCB DESIGN RULES, AS MANY VIAS AS POSSIBLE SHOULD BE PLACED ON THE LANDING PATTERN.
 3. IF VIAS CANNOT BE PLACED ON THE LANDING PATTERN, THEN AS MANY VIAS AS POSSIBLE SHOULD BE PLACED AS CLOSE TO THE LANDING PATTERN AS POSSIBLE FOR OPTIMAL THERMAL AND RF PERFORMANCE.
 4. RECOMMENDED VIA PATTERN SHOWN HAS 0.381 x 0.762 MM PITCH.

Figure 20. Recommended Mounting Configuration

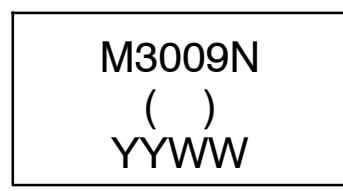
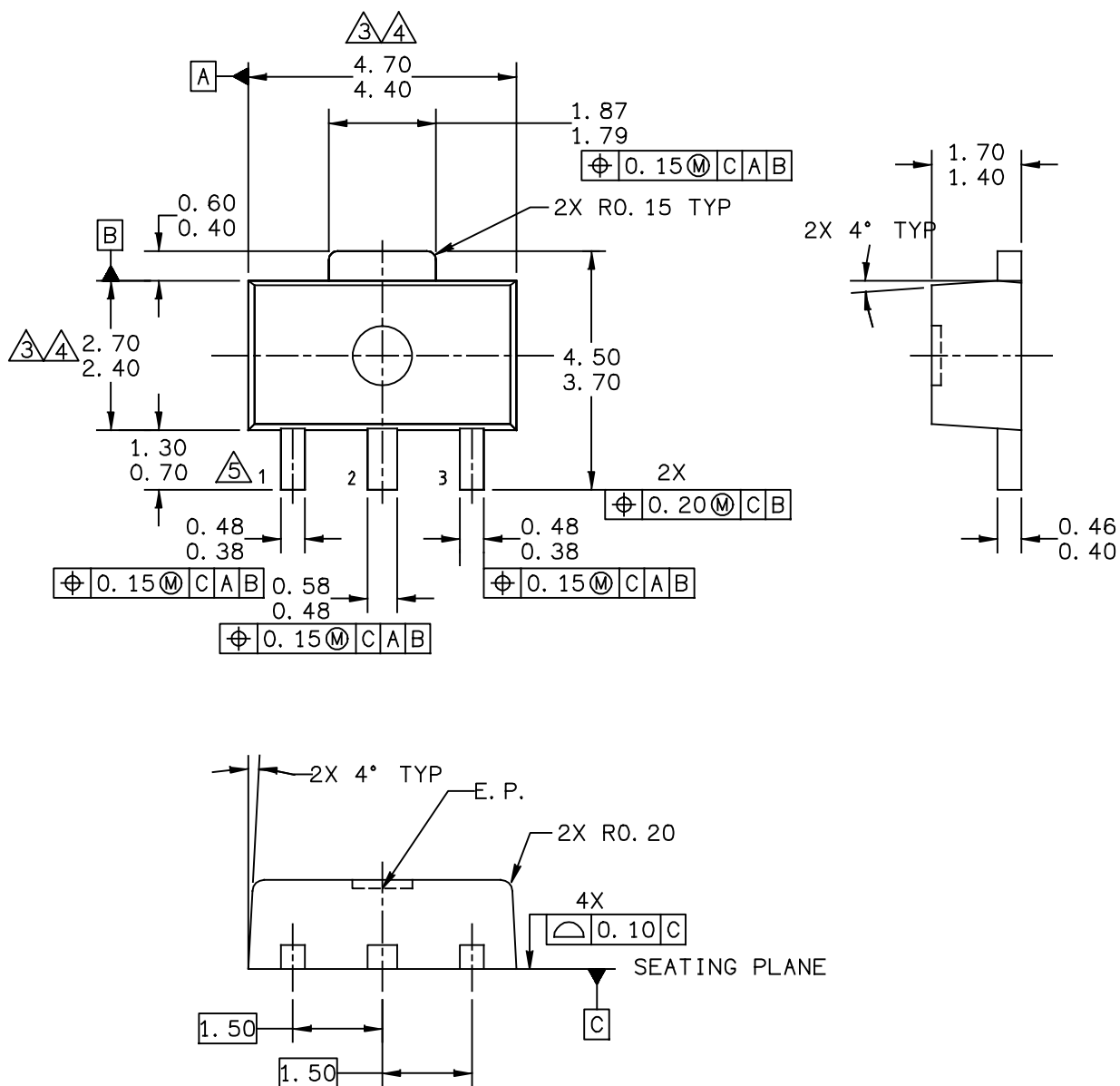
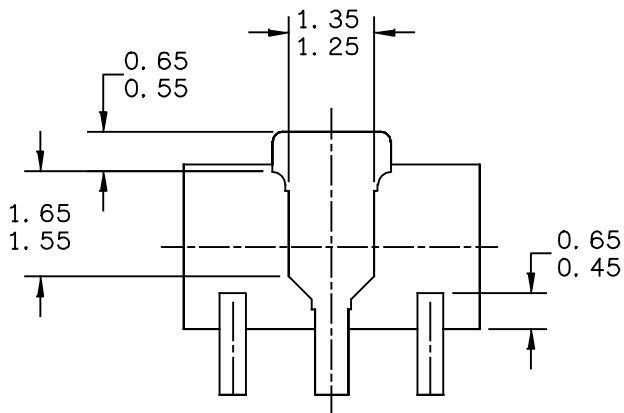

Figure 21. Product Marking

PACKAGE DIMENSIONS



© FREESCALE SEMICONDUCTOR, INC. ALL RIGHTS RESERVED.	MECHANICAL OUTLINE	PRINT VERSION NOT TO SCALE	
TITLE: SOT-89, 4 LEAD, 4.5 X 2.5 PKG, 1.5 MM PITCH	DOCUMENT NO: 98ASA10586D	REV: D	
	CASE NUMBER: 1514-02	27 JUN 2007	
	STANDARD: NON-JEDEC		



BOTTOM VIEW

CASE STYLE:

STYLE 1:

PIN 1. RF INPUT
 PIN 2. GROUND
 PIN 3. RF OUTPUT

STYLE 2:

PIN 1. GATE
 PIN 2. SOURCE
 PIN 3. DRAIN

© FREESCALE SEMICONDUCTOR, INC. ALL RIGHTS RESERVED.	MECHANICAL OUTLINE	PRINT VERSION NOT TO SCALE	
TITLE: SOT-89, 4 LEAD, 4.5 X 2.5 PKG, 1.5 MM PITCH	DOCUMENT NO: 98ASA10586D	REV: D	
	CASE NUMBER: 1514-02	27 JUN 2007	
	STANDARD: NON-JEDEC		

NOTES:

1 DIMENSIONING AND TOLERANCING PER ASME Y14.5M – 1994.

2 ALL DIMENSIONS ARE IN MILLIMETERS.

3 DIMENSIONS DOES NOT INCLUDE MOLD FLASH. PROTRUSIONS OR GATE BURRS. MOLD FLASH, PROTRUSIONS OR GATE BURRS SHALL NOT EXCEED 0.5mm PER END. DIMENSION DOES NOT INCLUDE INTERLEAD FLASH OR PROTRUSION. INTERLEAD FLASH OR PROTRUSION SHALL NOT EXCEED 0.5 mm PER SIDE.

4 DIMENSION ARE DETERMINED AT THE OUTMOST EXTREMES OF THE PLASTIC BODY EXCLUSIVE OF MOLD FLASH, TIE BAR BURRS, GATE BURRS AND INTERLEAD FLASH, BUT INCLUDING ANY MISMATCH BETWEEN THE TOP AND BOTTOM OF THE PLASTIC BODY.

5 TERMINAL NUMBERS ARE SHOWN FOR REFERENCE ONLY.

© FREESCALE SEMICONDUCTOR, INC. ALL RIGHTS RESERVED.	MECHANICAL OUTLINE	PRINT VERSION NOT TO SCALE	
TITLE: SOT-89, 4 LEAD, 4.5 X 2.5 PKG, 1.5 MM PITCH	DOCUMENT NO: 98ASA10586D	REV: D	
	CASE NUMBER: 1514-02	27 JUN 2007	
	STANDARD: NON-JEDEC		

Refer to the following resources to aid your design process.

Application Notes

- AN1955: Thermal Measurement Methodology of RF Power Amplifiers
- AN3100: General Purpose Amplifier and MMIC Biasing

Software

- .s2p File

Development Tools

- Printed Circuit Boards

For Software and Tools, do a Part Number search at <http://www.freescale.com>, and select the “Part Number” link. Go to Software & Tools on the part’s Product Summary page to download the respective tool.

REVISION HISTORY

The following table summarizes revisions to this document.

Revision	Date	Description
3	Mar. 2007	<ul style="list-style-type: none"> • Corrected and updated Part Numbers in Tables 8 and 9, Component Designations and Values, to RoHS compliant part numbers, pp. 6, 7
4	July 2007	<ul style="list-style-type: none"> • Replaced Case Outline 1514-01 with 1514-02, Issue D, pp. 1, 11-13. Case updated to add missing dimension for Pin 1 and Pin 3.
5	Mar. 2008	<ul style="list-style-type: none"> • Removed Footnote 2, Continuous voltage and current applied to device, from Table 2, Maximum Ratings, p. 1 • Corrected Fig. 13, Single-Carrier W-CDMA Adjacent Channel Power Ratio versus Output Power y-axis (ACPR) unit of measure to dBc, p. 5 • Corrected S-Parameter table frequency column label to read “MHz” versus “GHz” and corrected frequency values from GHz to MHz, pp. 8, 9
6	Feb. 2012	<ul style="list-style-type: none"> • Corrected temperature at which Theta_{JC} is measured from 25°C to 88°C and added “no RF applied” to Thermal Characteristics table to indicate that thermal characterization is performed under DC test with no RF signal applied, p. 1 • Table 6, ESD Protection Characterization, removed the word “Minimum” after the ESD class rating. ESD ratings are characterized during new product development but are not 100% tested during production. ESD ratings provided in the data sheet are intended to be used as a guideline when handling ESD sensitive devices, p. 3 • Removed I_{CC} bias callout from applicable graphs and Table 10, Common Emitter S-Parameters heading as bias is not a controlled value, pp. 4-9 • Added .s2p File availability to Product Software and Printed Circuit Boards to Development Tools, p. 14
7	Sept. 2014	<ul style="list-style-type: none"> • Added Fig. 21, Product Marking, p. 9

LIFETIME BUY

LAST ORDER 24 MAY 14 LAST SHIP 24 MAY 15

How to Reach Us:

Home Page:
freescale.com

Web Support:
freescale.com/support

Information in this document is provided solely to enable system and software implementers to use Freescale products. There are no express or implied copyright licenses granted hereunder to design or fabricate any integrated circuits based on the information in this document.

Freescale reserves the right to make changes without further notice to any products herein. Freescale makes no warranty, representation, or guarantee regarding the suitability of its products for any particular purpose, nor does Freescale assume any liability arising out of the application or use of any product or circuit, and specifically disclaims any and all liability, including without limitation consequential or incidental damages. "Typical" parameters that may be provided in Freescale data sheets and/or specifications can and do vary in different applications, and actual performance may vary over time. All operating parameters, including "typicals," must be validated for each customer application by customer's technical experts. Freescale does not convey any license under its patent rights nor the rights of others. Freescale sells products pursuant to standard terms and conditions of sale, which can be found at the following address: freescale.com/SalesTermsandConditions.

Freescale and the Freescale logo are trademarks of Freescale Semiconductor, Inc., Reg. U.S. Pat. & Tm. Off. All other product or service names are the property of their respective owners.

© 2005–2008, 2012, 2014 Freescale Semiconductor, Inc.