

OMNIMATE Signal - series LMF LMF 5.00/23/90 3.5SN OR BX

Weidmüller Interface GmbH & Co. KG
Klingenbergstraße 16
D-32758 Detmold
Germany
Fon: +49 5231 14-0
Fax: +49 5231 14-292083
www.weidmueller.com

Product image

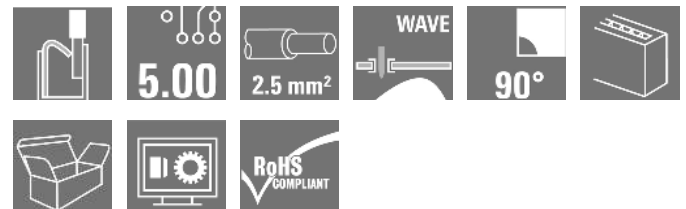

Similar to illustration

The new LMF allows us to meet the current market requirements for a PCB terminal with PUSH IN connection system for wire cross-sections up to 2.5 mm²

- PUSH IN connection system
- LMF with pusher for opening the terminal point
- LMFS without pusher, the terminal point is opened with a screwdriver
- Integrated test point
- 90° and 180° wire outlet direction

General ordering data

Type	LMF 5.00/23/90 3.5SN OR BX
Order No.	1331940000
Version	Printed circuit board terminals, 5.00 mm, No. of poles: 23, 90°, Solder pin length (l): 3.5 mm, tinned, orange, PUSH IN, Clamping range, max. : 2.5 mm ² , Box
GTIN (EAN)	4050118135657
Qty.	10 pc(s).
Product data	IEC: 400 V / 24 A / 0.5 - 2.5 mm ² UL: 300 V / 20 A / AWG 24 - AWG 12
Packaging	Box

OMNIMATE Signal - series LMF
LMF 5.00/23/90 3.5SN OR BX

Weidmüller Interface GmbH & Co. KG
 Klingenbergstraße 16
 D-32758 Detmold
 Germany
 Fon: +49 5231 14-0
 Fax: +49 5231 14-292083
 www.weidmueller.com

Technical data**Dimensions and weights**

Width	117.7 mm	Width (inches)	4.634 inch
Height	18.3 mm	Height (inches)	0.72 inch
Height of lowest version	14.8 mm	Depth	19.2 mm
Depth (inches)	0.756 inch	Net weight	32.68 g

System parameters

Product family	OMNIMATE Signal - series LMF	Wire connection method	PUSH IN
Mounting onto the PCB	THT solder connection	Conductor outlet direction	90°
Pitch in mm (P)	5 mm	Pitch in inches (P)	0.197 inch
No. of poles	23	Fitted by customer	No
Max. adjacent poles per row	24	Solder pin length (l)	3.5 mm
Solder pin dimensions	d = 0.8 mm	Solder eyelet hole diameter (D)	1.1 mm
Solder eyelet hole diameter tolerance (D)+	0, 1 mm	Number of solder pins per pole	2
Screwdriver blade	0.6 x 3.5	Screwdriver blade standard	DIN 5264
Stripping length	10 mm	L1 in mm	110 mm
L1 in inches	4.331 inch	Touch-safe protection acc. to DIN VDE 0470	IP 20
Touch-safe protection acc. to DIN VDE 57 106	Safe from finger touch		

Material data

Insulating material	Wemid (PA)	Colour code	orange
Colour chart (similar)	RAL 2000	CTI	≥ 600
Insulation strength	≥ 10 ⁸ Ω	UL 94 flammability rating	V-0
Contact material	CuSn	Contact surface	tinned
Coating	4-6 µm SN	Tinning type	matt
Layer structure of solder connection	4-6 µm Sn matt	Storage temperature, min.	-25 °C
Storage temperature, max.	55 °C	Max. relative humidity during storage	80 %
Operating temperature, min.	-50 °C	Operating temperature, max.	120 °C
Temperature range, installation, min.	-25 °C	Temperature range, installation, max.	120 °C

Conductors suitable for connection

Clamping range, min.	0.12 mm ²	Clamping range, max.	2.5 mm ²
Wire connection cross section AWG, min.	AWG 24	Wire connection cross section AWG, max.	AWG 12
Solid, min. H05(07) V-U	0.5 mm ²	Solid, max. H05(07) V-U	2.5 mm ²
Flexible, min. H05(07) V-K	0.25 mm ²	Flexible, max. H05(07) V-K	2.5 mm ²
w. plastic collar ferrule, DIN 46228 pt 4, min.	0.25 mm ²	w. plastic collar ferrule, DIN 46228 pt 4, max.	2.5 mm ²
w. wire end ferrule, DIN 46228 pt 1, min.	0.25 mm ²	w. wire end ferrule, DIN 46228 pt 1, max.	2.5 mm ²
Plug gauge in accordance with EN 60999 a x b; ø	2.4 mm x 1.5 mm		

OMNIMATE Signal - series LMF LMF 5.00/23/90 3.5SN OR BX

Weidmüller Interface GmbH & Co. KG
Klingenbergstraße 16
D-32758 Detmold
Germany
Fon: +49 5231 14-0
Fax: +49 5231 14-292083
www.weidmueller.com

Technical data

Rated data acc. to IEC

tested acc. to standard	IEC 60664-1, IEC 61984	Rated current, min. no. of poles (Tu=20°C)	24 A
Rated current, max. no. of poles (Tu=20°C)	24 A	Rated current, min. no. of poles (Tu=40°C)	24 A
Rated current, max. no. of poles (Tu=40°C)	24 A	Rated voltage for surge voltage class / pollution degree II/2	400 V
Rated voltage for surge voltage class / pollution degree III/2	320 V	Rated voltage for surge voltage class / pollution degree III/3	250 V
Rated impulse voltage for surge voltage class/ pollution degree II/2	4 kV	Rated impulse voltage for surge voltage class/ pollution degree III/2	4 kV
Rated impulse voltage for surge voltage class/ contamination degree III/3	4 kV	Short-time withstand current resistance	3 x 1s with 120 A

Rated data acc. to CSA

Institute (CSA)		Certificate No. (CSA)	20039-1815154
Rated voltage (Use group B / CSA)	300 V	Rated voltage (Use group D / CSA)	300 V
Rated current (Use group B / CSA)	20 A	Rated current (Use group D / CSA)	10 A
Wire cross-section, AWG, min.	AWG 24	Wire cross-section, AWG, max.	AWG 12
Reference to approval values	Specifications are maximum values, details - see approval certificate.		

Rated data acc. to UL 1059

Institute (cURus)		Certificate No. (cURus)	E60693
Rated voltage (Use group B / UL 1059)	300 V	Rated voltage (Use group D / UL 1059)	300 V
Rated current (Use group B / UL 1059)	20 A	Rated current (Use group D / UL 1059)	10 A
Wire cross-section, AWG, min.	AWG 24	Wire cross-section, AWG, max.	AWG 12
Reference to approval values	Specifications are maximum values, details - see approval certificate.		

Packaging

Packaging	Box	VPE length	348 mm
VPE width	135 mm	VPE height	30 mm

Classifications

ETIM 3.0	EC001284	ETIM 4.0	EC002643
ETIM 5.0	EC002643	ETIM 6.0	EC002643
eClass 6.2	27-26-11-01	eClass 7.1	27-44-04-01
eClass 8.1	27-44-04-01	eClass 9.0	27-44-04-01
eClass 9.1	27-44-04-01		

Data sheet

OMNIMATE Signal - series LMF LMF 5.00/23/90 3.5SN OR BX

Weidmüller Interface GmbH & Co. KG
Klingenbergstraße 16
D-32758 Detmold
Germany
Fon: +49 5231 14-0
Fax: +49 5231 14-292083
www.weidmueller.com

Technical data

Notes

Notes	<ul style="list-style-type: none"> • Additional colours on request • Rated current related to rated cross-section & min. No. of poles. • Wire end ferrule without plastic collar to DIN 46228/1 • Wire end ferrule with plastic collar to DIN 46228/4 • P on drawing = pitch • Rated data refer only to the component itself. Clearance and creepage distances to other components are to be designed in accordance with the relevant application standards. • The test point can only be used as potential-pickup point.
-------	--

IPC conformity	Conformity: The products are developed, manufactured and delivered according international recognized standards and norms and comply with the assured properties in the data sheet resp. fulfill decorative properties in accordance with IPC-A-610 "Class 2". Further claims on the products can be evaluated on request.
----------------	--

Approvals

Approvals



ROHS	Conform
------	---------

Downloads

Approval/Certificate/Document of Conformity	Declaration of the Manufacturer
Brochure/Catalogue	FL DRIVES EN FL ANALO.SIGN.CONV. EN MB DEVICE MANUF. EN FL DRIVES DE CAT 2 PORTFOLIOGUIDE EN FL BUILDING SAFETY EN FL APPL LED LIGHTING EN FLIndustr.CONTROLS EN FL MACHINE SAFETY EN FL HEATING ELECTR EN FL APPL INVERTER EN FL BASE STATION EN FL ELEVATOR EN FL POWER SUPPLY EN FL 72H SAMPLE SER EN PO OMNIMATE EN
Engineering Data	EPLAN.WSCAD

OMNIMATE Signal - series LMF
LMF 5.00/23/90 3.5SN OR BX

Weidmüller Interface GmbH & Co. KG
 Klingenbergstraße 16
 D-32758 Detmold
 Germany
 Fon: +49 5231 14-0
 Fax: +49 5231 14-292083
 www.weidmueller.com

Drawings

Dimensional drawing

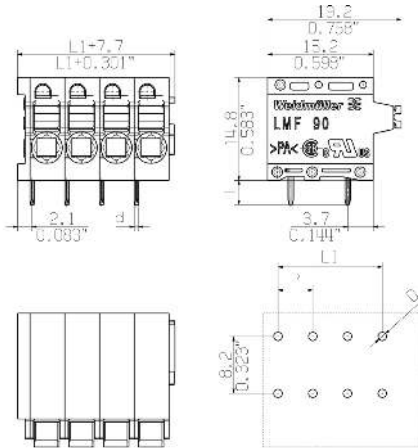

Graph

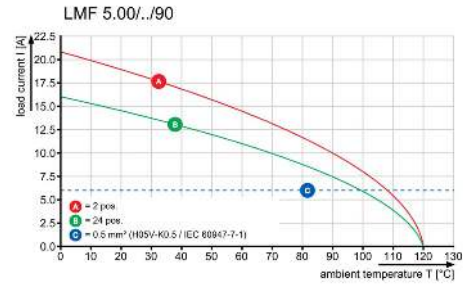

Graph

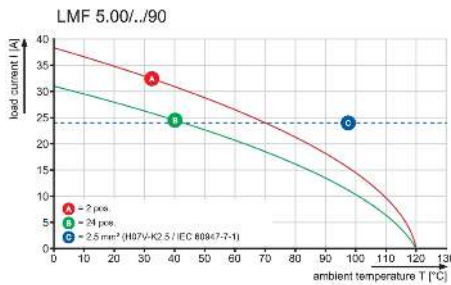

Product benefits

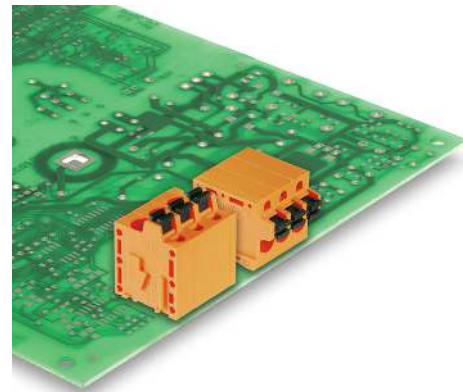

- Optional conductor outlet direction
- Stable mechanical design

Product benefits

Product benefits

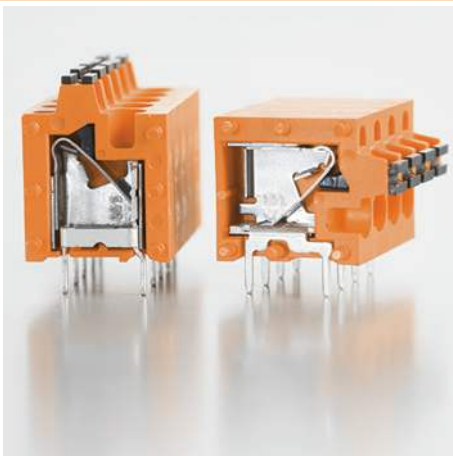

- High reliability of the current capacity

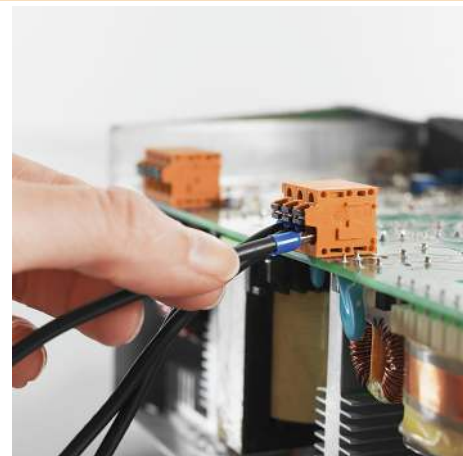

- Direct conductor entry
- Cross section up to 2.5 mm²

Data sheet**OMNIMATE Signal - series LMF
LMF 5.00/23/90 3.5SN OR BX**

Weidmüller Interface GmbH & Co. KG
Klingenbergstraße 16
D-32758 Detmold
Germany
Fon: +49 5231 14-0
Fax: +49 5231 14-292083
www.weidmueller.com

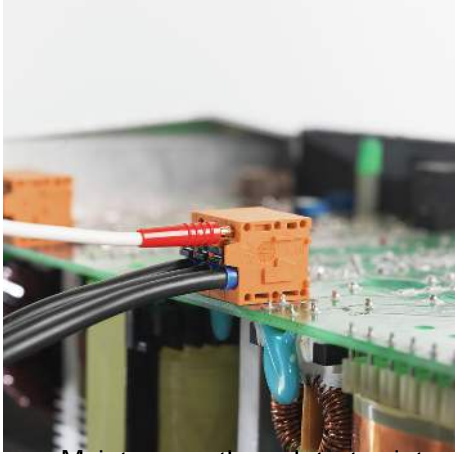
Drawings**Product benefits**

- Maintenance through test point

MASSE OHNE TOLERANZ SIND KEINE PRUEFMASSE
 DIMS. WITHOUT TOLERANCE ARE NOT CONTROL DIMS.

DIE DEUTSCHE VERSION IST VERBINDLICH
 THE GERMAN VERSION IS BINDING

ALLGEMEINGUELTIGE KUNDENZEICHNUNG, AKTUELLER STAND NUR AUF ANFRAGE
 GENERAL CUSTOMER DRAWING, TOPICAL VERSION ONLY IF REQUIRED

SHOWN: LMF 5.00/04/90 3.5

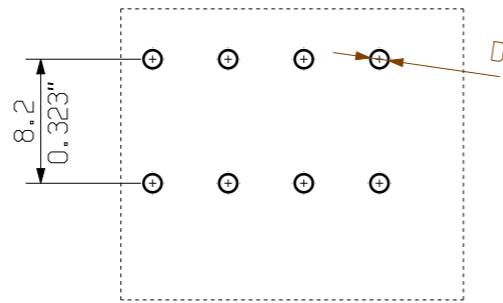
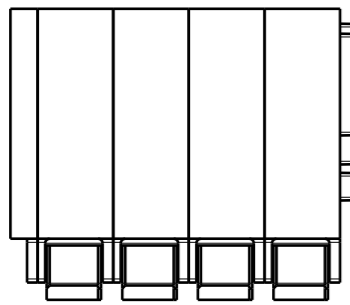
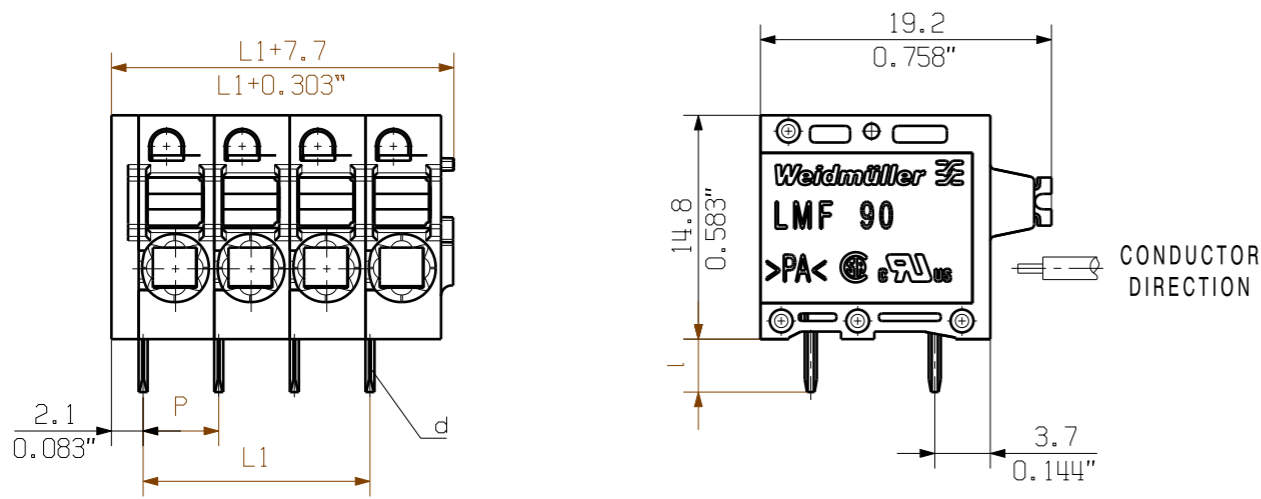

HOLE PATTERN

M 1/1

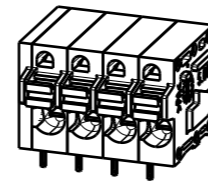

SHOWN: LMFS 5.00/04/90 3.5

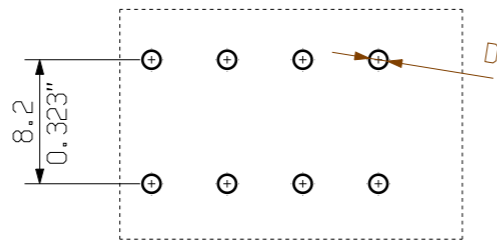
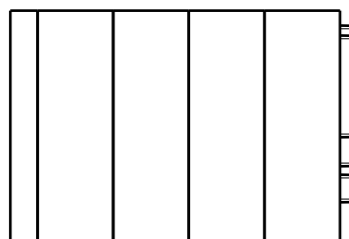
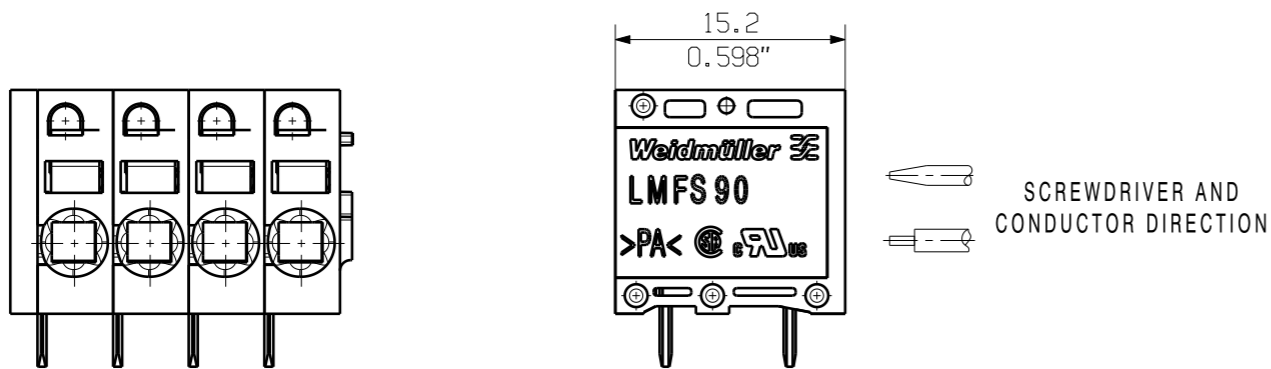

HOLE PATTERN

M 1/1

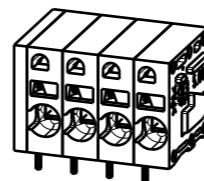

P = 5.00 RASTER PITCH
 D = $\varnothing 1.1 + 0.1$
 0.043"
 d = 0.6x0.8
 0.024"x0.031"
 l = 3.5
 0.138"

For the mounting of PCBs, it should be noted that the rated data relates only to the PCB components alone. The necessary creepage and clearance paths must be observed in connection with the respective applicant in accordance to IEC 664 / VDE 0110. The current-carrying capacity and pitch tolerance is to be determined according to DIN IEC 326 part 3 very fine.

Weidmüller PCB components are tested to the DIN EN 61984 standard, and are valid for its field of application. Provided that the components are used to the intended purpose, all requirements with respect to the occurring of electrical, mechanical, thermic and corrosive stress will be satisfied.

24	115.00	4.528
23	110.00	4.331
22	105.00	4.134
21	100.00	3.937
20	95.00	3.740
19	90.00	3.543
18	85.00	3.346
17	80.00	3.150
16	75.00	2.953
15	70.00	2.756
14	65.00	2.559
13	60.00	2.362
12	55.00	2.165
11	50.00	1.969
10	45.00	1.772
9	40.00	1.575
8	35.00	1.378
7	30.00	1.181
6	25.00	0.984
5	20.00	0.787
4	15.00	0.591
3	10.00	0.394
2	5.00	0.197
n POLES	L1 [mm]	L1 [inch]

GENERAL TOLERANCE: DIN ISO 2768-m		70657/4 26.06.13 TIELKER_S 01		CAT.NO.:	
		MODIFICATION			
		DATE	NAME	DRAWING NO. C 55663 03	
SCALE: 2/1		DRAWN	25.01.2012	REGLIN_A	ISSUE NO.
SUPERSEDES: .		RESPONSIBLE		SCHMITZ_T	
		CHECKED	26.06.2013	HECKERT_M	
		APPROVED		HANKE_D	
				SHEET 01 OF 01 SHEETS	
				LMF... 5.00/.../90 ... LEITERPLATTENANSCHLUSSKLEMME PCB TERMINAL	
				PRODUCT FILE: LMF 5.0X 7403	

WEITERGABE SOWIE VERVIELFÄLTIGUNG DIESES DOKUMENTS, VERWERTUNG UND MITTEILUNG SEINES INHALTS SIND VERBOTEN, SOWEIT NICHT AUSDRUECKLICH GESTATTET.
 ZUWIDERHANDLUNGEN VERPFLICHTEN ZU SCHADENERSATZ. ALLE RECHTE FUER DEN FALL DER PATENT-, GEBRAUCHSMUSTER- ODER GESCHMACKSMUSTEREINTRAGUNG VORBEHALTEN.
 THE REPRODUCTION, DISTRIBUTION AND UTILIZATION OF THIS DOCUMENT AS WELL AS THE COMMUNICATION OF ITS CONTENTS TO OTHERS WITHOUT EXPLICIT AUTHORIZATION IS PROHIBITED.
 OFFENDERS WILL BE HELD LIABLE FOR THE PAYMENT OF DAMAGES. WEIDMUELLER EXCLUSIVELY RESERVES THE RIGHT TO FILE FOR PATENTS, UTILITY MODELS OR DESIGNS.
 © WEIDMUELLER INTERFACE GmbH & Co.KG

Recommended wave soldering profiles

Weidmüller Interface GmbH & Co. KG
 Klingenbergstraße 16
 D-32758 Detmold
 Germany
 Fon: +49 5231 14-0
 Fax: +49 5231 14-292083
 www.weidmueller.com

Single Wave:

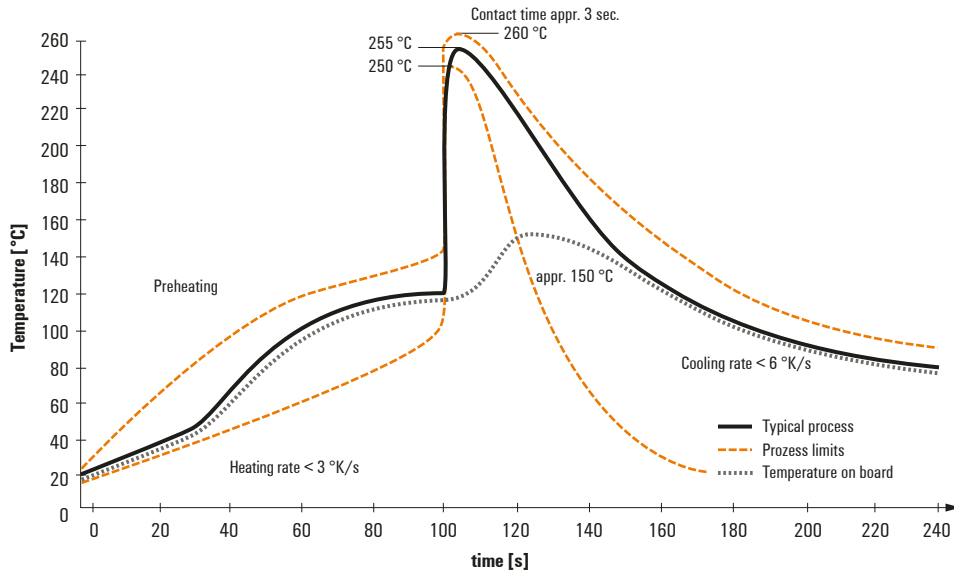

Double Wave:

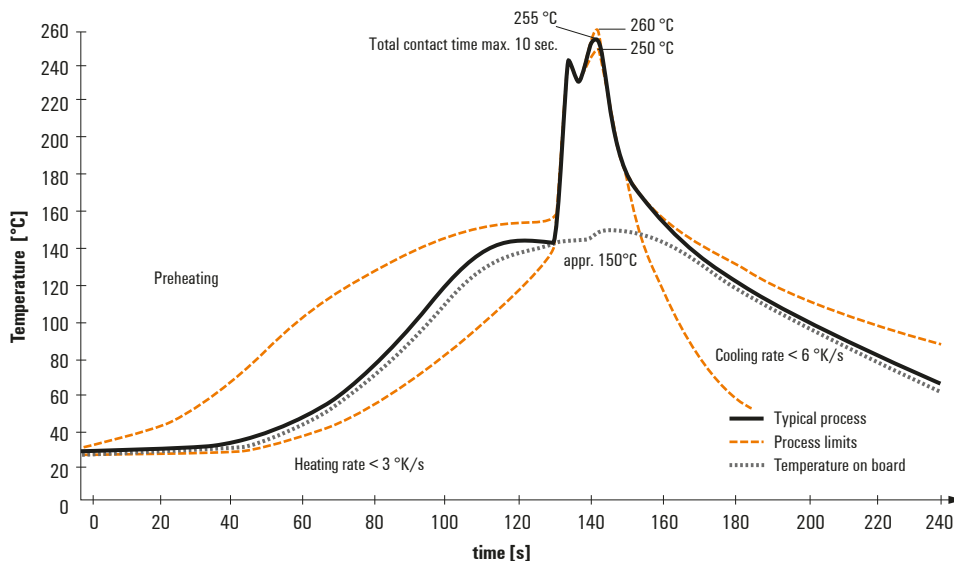

Wave soldering profiles

Wired connection elements should be processed in accordance with the DIN EN 61760-1 standard. We have included two recommendations for practical wave soldering profiles, with which Weidmüller PCB terminals and connectors are qualified.

When choosing a suitable profile for your application, the following factors also need to be considered:

- PCB thickness
- Proportion of Cu in the layers
- Single/double-sided assembly
- Product range
- Heating and cooling rates

The single and double wave profiles each indicate the recommended operating range, including the maximum soldering temperature of 260°C. In practice, the maximum soldering temperature is quite often well below the above maximum profile.