

SN54AS821A, SN74AS821A 10-BIT BUS-INTERFACE FLIP-FLOPS WITH 3-STATE OUTPUTS

SDAS230A - DECEMBER 1983 - REVISED AUGUST 1995

- Functionally Equivalent to AMD's AM29821
- Provide Extra Data Width Necessary for Wider Address/Data Paths or Buses With Parity
- Outputs Have Undershoot-Protection Circuitry
- Power-Up High-Impedance State
- Buffered Control Inputs to Reduce dc Loading Effects
- Package Options Include Plastic Small-Outline (DW) Packages, Ceramic Chip Carriers (FK), and Standard Plastic (NT) and Ceramic (JT) 300-mil DIPs

description

These 10-bit flip-flops feature 3-state outputs designed specifically for driving highly capacitive or relatively low-impedance loads. They are particularly suitable for implementing wider buffer registers, I/O ports, bidirectional bus drivers with parity, and working registers.

The ten flip-flops are edge-triggered D-type flip-flops. On the positive transition of the clock (CLK) input, the Q outputs are true to the data (D) input.

A buffered output-enable (\overline{OE}) input can be used to place the ten outputs in either a normal logic state (high or low logic levels) or a high-impedance state. In the high-impedance state, the outputs neither load nor drive the bus lines significantly. The high-impedance state and increased drive provide the capability to drive bus lines without interface or pullup components.

\overline{OE} does not affect the internal operation of the flip-flops. Previously stored data can be retained or new data can be entered while the outputs are in the high-impedance state.

The SN54AS821A is characterized for operation over the full military temperature range of -55°C to 125°C . The SN74AS821A is characterized for operation from 0°C to 70°C .

SN54AS821A ... JT PACKAGE
SN74AS821A ... DW OR NT PACKAGE
(TOP VIEW)

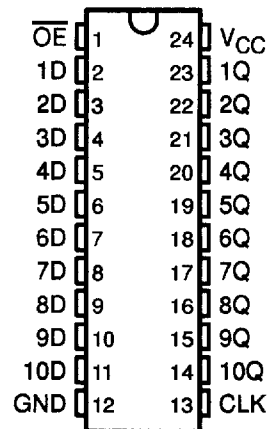

SN54AS821A ... FK PACKAGE
(TOP VIEW)

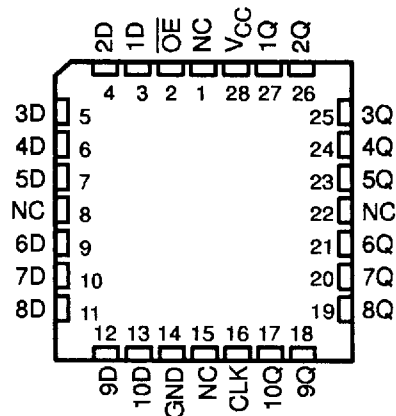

NC - No internal connection

FUNCTION TABLE
(each flip-flop)

INPUTS			OUTPUT
\overline{OE}	CLK	D	Q
L	\uparrow	H	H
L	\uparrow	L	L
L	L	X	Q_0
H	X	X	Z

PRODUCTION DATA Information is current as of publication date. Products conform to specifications per the terms of Texas Instruments standard warranty. Production processing does not necessarily include testing of all parameters.

 **TEXAS
INSTRUMENTS**

POST OFFICE BOX 655303 • DALLAS, TEXAS 75265

8961723 0104224 692

Copyright © 1995, Texas Instruments Incorporated

SN54AS821A, SN74AS821A
10-BIT BUS-INTERFACE FLIP-FLOPS
WITH 3-STATE OUTPUTS

SDAS230A – DECEMBER 1983 – REVISED AUGUST 1995

logic symbol†

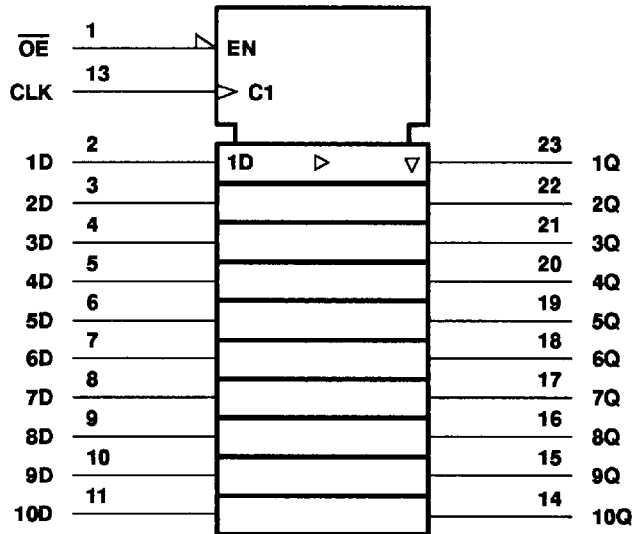

† This symbol is in accordance with ANSI/IEEE Std 91-1984 and IEC Publication 617-12. Pin numbers shown are for the DW, JT, and NT packages.

logic diagram (positive logic)

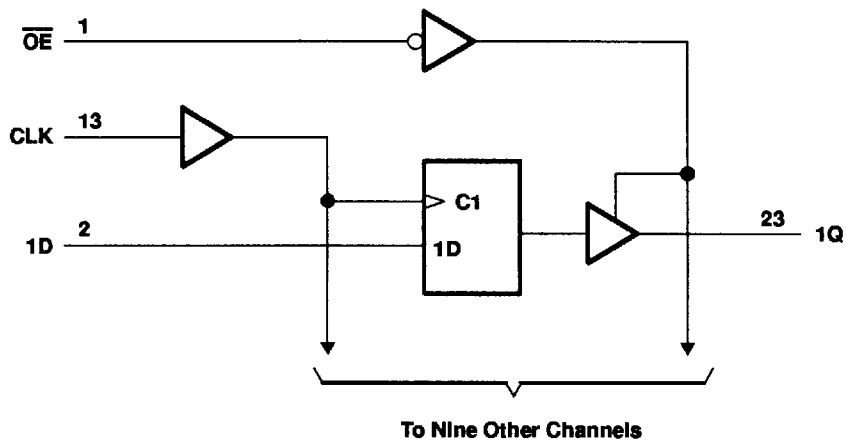

Pin numbers shown are for the DW, JT, and NT packages.

absolute maximum ratings over operating free-air temperature range (unless otherwise noted)‡

Supply voltage, V_{CC}	7 V
Input voltage, V_I	7 V
Voltage applied to a disabled 3-state output	5.5 V
Operating free-air temperature range, T_A : SN54AS821A	-55°C to 125°C
SN74AS821A	0°C to 70°C
Storage temperature range	-65°C to 150°C

‡ Stresses beyond those listed under "absolute maximum ratings" may cause permanent damage to the device. These are stress ratings only, and functional operation of the device at these or any other conditions beyond those indicated under "recommended operating conditions" is not implied. Exposure to absolute-maximum-rated conditions for extended periods may affect device reliability.



POST OFFICE BOX 655303 • DALLAS, TEXAS 75265

8961723 0104225 529

SN54AS821A, SN74AS821A 10-BIT BUS-INTERFACE FLIP-FLOPS WITH 3-STATE OUTPUTS

SDAS230A - DECEMBER 1983 - REVISED AUGUST 1995

recommended operating conditions

		SN54AS821A			SN74AS821A			UNIT
		MIN	NOM	MAX	MIN	NOM	MAX	
V _{CC}	Supply voltage	4.5	5	5.5	4.5	5	5.5	V
V _{IH}	High-level input voltage	2			2			V
V _{IL}	Low-level input voltage			0.8			0.8	V
I _{OH}	High-level output current			-24			-24	mA
I _{OL}	Low-level output current			32			48	mA
t _w *	Pulse duration, CLK high or low	9			8			ns
t _{su} *	Setup time, data before CLK↑	7			6			ns
t _h *	Hold time, data after CLK↑	0			0			ns
T _A	Operating free-air temperature	-55		125	0		70	°C

* On products compliant to MIL-STD-883, Class B, this parameter is based on characterization data but is not production tested.

electrical characteristics over recommended operating free-air temperature range (unless otherwise noted)

PARAMETER	TEST CONDITIONS		SN54AS821A			SN74AS821A			UNIT
			MIN	TYP†	MAX	MIN	TYP†	MAX	
V _{IK}	V _{CC} = 4.5 V, I _I = -18 mA				-1.2			-1.2	V
V _{OH}	V _{CC} = 4.5 V to 5.5 V, I _{OH} = -2 mA		V _{CC} - 2			V _{CC} - 2			V
	V _{CC} = 4.5 V	I _{OH} = -15 mA	2.4	3.2		2.4	3.2		
		I _{OH} = -24 mA	2			2			
V _{OL}	V _{CC} = 4.5 V	I _{OL} = 32 mA		0.25	0.5				V
		I _{OL} = 48 mA				0.35	0.5		
I _{OZH}	V _{CC} = 5.5 V, V _O = 2.7 V			50			50	μA	
I _{OZL}	V _{CC} = 5.5 V, V _I = 0.4 V			-50			-50	μA	
I _I	V _{CC} = 5.5 V, V _I = 7 V			0.1			0.1	mA	
I _{IH}	V _{CC} = 5.5 V, V _I = 2.7 V			20			20	μA	
I _{IL}	V _{CC} = 5.5 V, V _I = 0.4 V			-0.5			-0.5	mA	
I _{O‡}	V _{CC} = 5.5 V, V _O = 2.25 V			-30			-112	mA	
I _{CC}	V _{CC} = 5.5 V	Outputs high		55	88		55	88	mA
		Outputs low		68	109		68	109	
		Outputs disabled		70	113		70	113	

† All typical values are at V_{CC} = 5 V, T_A = 25°C.

‡ The output conditions have been chosen to produce a current that closely approximates one half of the true short-circuit output current, I_{OS}.



POST OFFICE BOX 855303 • DALLAS, TEXAS 75265

8961723 0104226 465

SN54AS821A, SN74AS821A
10-BIT BUS-INTERFACE FLIP-FLOPS
WITH 3-STATE OUTPUTS

SDAS230A - DECEMBER 1983 - REVISED AUGUST 1995

switching characteristics (see Figure 1)

PARAMETER	FROM (INPUT)	TO (OUTPUT)	V _{CC} = 4.5 V to 5.5 V, C _L = 50 pF, R ₁ = 500 Ω, R ₂ = 500 Ω, T _A = MIN to MAX†				UNIT
			SN54AS821A		SN74AS821A		
			MIN	MAX	MIN	MAX	
t _{PLH}	CLK	Any Q	3.5	9	3.5	7.5	ns
t _{PHL}			3.5	14	3.5	13	
t _{PZH}	\overline{OE}	Any Q	4	12	3	11	ns
t _{PZL}			4	13	4	12	
t _{PHZ}	\overline{OE}	Any Q	1	10	1	8	ns
t _{PLZ}			1	10	1	8	

† For conditions shown as MIN or MAX, use the appropriate value specified under recommended operating conditions.



POST OFFICE BOX 655303 • DALLAS, TEXAS 75265

8961723 0104227 3T1

PARAMETER MEASUREMENT INFORMATION
SERIES 54ALS/74ALS AND 54AS/74AS DEVICES

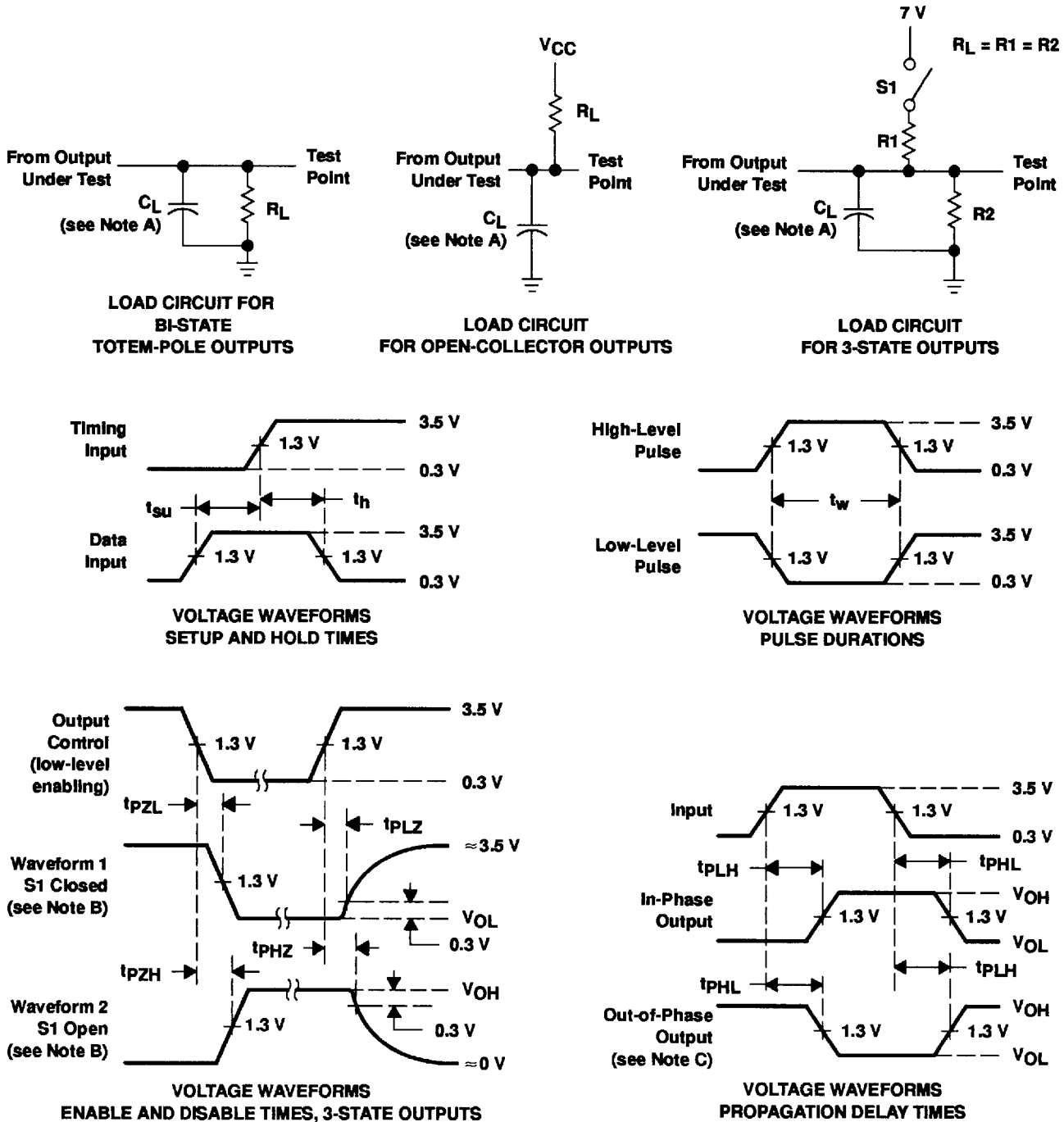

- NOTES: A. C_L includes probe and jig capacitance.
B. Waveform 1 is for an output with internal conditions such that the output is low except when disabled by the output control. Waveform 2 is for an output with internal conditions such that the output is high except when disabled by the output control.
C. When measuring propagation delay items of 3-state outputs, switch S1 is open.
D. All input pulses have the following characteristics: $PRR \leq 1$ MHz, $t_r = t_f = 2$ ns, duty cycle = 50%.
E. The outputs are measured one at a time with one transition per measurement.

Figure 1. Load Circuits and Voltage Waveforms