

## Trench gate field-stop 650 V, 20 A, soft-switching IH series IGBT in a TO-247 long leads package

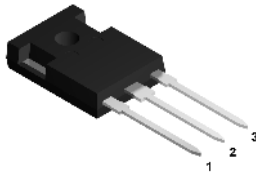

TO-247 long leads

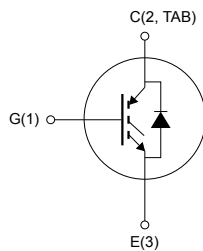

NG1E3C2T

### Features

- Designed for soft-commutation
- Maximum junction temperature:  $T_J = 175\text{ °C}$
- $V_{CE(sat)} = 1.55\text{ V (typ.) @ } I_C = 20\text{ A}$
- Minimized tail current
- Tight parameter distribution
- Low thermal resistance
- Low drop voltage freewheeling co-packaged diode
- Positive  $V_{CE(sat)}$  temperature coefficient

### Applications

- Induction heating
- Resonant converters
- Microwave ovens

### Description

The newest IGBT 650 V soft-switching IH series has been developed using an advanced proprietary trench gate field-stop structure, whose performance is optimized both in conduction and switching losses for soft commutation. A freewheeling diode with a low drop forward voltage is included. The result is a product specifically designed to maximize efficiency for any resonant and soft-switching applications.



#### Product status link

[STGWA20IH65DF](#)

#### Product summary

<b>Order code</b>	STGWA20IH65DF
<b>Marking</b>	G20IH65DF
<b>Package</b>	TO-247 long leads
<b>Packing</b>	Tube

# 1 Electrical ratings

**Table 1. Absolute maximum ratings**

Symbol	Parameter	Value	Unit
$V_{CES}$	Collector-emitter voltage ( $V_{GE} = 0$ V)	650	V
$I_C$	Continuous collector current at $T_C = 25$ °C	40	A
	Continuous collector current at $T_C = 100$ °C	20	
$I_{CP}^{(1)}$	Pulsed collector current	60	
$V_{GE}$	Gate-emitter voltage	±20	V
	Transient gate-emitter voltage ( $t_p \leq 10$ μs)	±30	
$I_F$	Continuous forward current at $T_C = 25$ °C	20	A
	Continuous forward current at $T_C = 100$ °C	10	
$I_{FP}^{(1)}$	Pulsed forward current	60	
$P_{TOT}$	Total power dissipation at $T_C = 25$ °C	159	W
$T_{STG}$	Storage temperature range	- 55 to 150	°C
$T_J$	Operating junction temperature range	- 55 to 175	

1. Pulse width limited by maximum junction temperature.

**Table 2. Thermal data**

Symbol	Parameter	Value	Unit
$R_{thJC}$	Thermal resistance junction-case IGBT	0.94	°C/W
	Thermal resistance junction-case diode	2.08	
$R_{thJA}$	Thermal resistance junction-ambient	50	

## 2 Electrical characteristics

$T_C = 25\text{ °C}$  unless otherwise specified

**Table 3. Static characteristics**

Symbol	Parameter	Test conditions	Min.	Typ.	Max.	Unit
$V_{(BR)CES}$	Collector-emitter breakdown voltage	$V_{GE} = 0\text{ V}$ , $I_C = 250\text{ }\mu\text{A}$	650			V
$V_{CE(sat)}$	Collector-emitter saturation voltage	$V_{GE} = 15\text{ V}$ , $I_C = 20\text{ A}$		1.55	2.05	V
		$V_{GE} = 15\text{ V}$ , $I_C = 20\text{ A}$ , $T_J = 125\text{ °C}$		1.80		
		$V_{GE} = 15\text{ V}$ , $I_C = 20\text{ A}$ , $T_J = 175\text{ °C}$		1.95		
$V_F$	Forward on-voltage	$I_F = 10\text{ A}$		1.50	2.15	V
		$I_F = 10\text{ A}$ , $T_J = 125\text{ °C}$		1.35		
		$I_F = 10\text{ A}$ , $T_J = 175\text{ °C}$		1.25		
		$I_F = 20\text{ A}$		1.85		
$V_{GE(th)}$	Gate threshold voltage	$V_{CE} = V_{GE}$ , $I_C = 1\text{ mA}$	5	6	7	V
$I_{CES}$	Collector cut-off current	$V_{GE} = 0\text{ V}$ , $V_{CE} = 650\text{ V}$			25	$\mu\text{A}$
$I_{GES}$	Gate-emitter leakage current	$V_{CE} = 0\text{ V}$ , $V_{GE} = \pm 20\text{ V}$			$\pm 250$	nA

**Table 4. Dynamic characteristics**

Symbol	Parameter	Test conditions	Min.	Typ.	Max.	Unit
$C_{ies}$	Input capacitance	$V_{CE} = 25\text{ V}$ , $f = 1\text{ MHz}$ , $V_{GE} = 0\text{ V}$	-	1000	-	pF
$C_{oes}$	Output capacitance		-	62	-	
$C_{res}$	Reverse transfer capacitance		-	25	-	
$Q_g$	Total gate charge	$V_{CC} = 520\text{ V}$ , $I_C = 20\text{ A}$ , $V_{GE} = 0\text{ to }15\text{ V}$ (see Figure 23. Gate charge test circuit)	-	56	-	nC
$Q_{ge}$	Gate-emitter charge		-	9.6	-	
$Q_{gc}$	Gate-collector charge		-	26.5	-	

**Table 5. IGBT switching characteristics (inductive load)**

Symbol	Parameter	Test conditions	Min.	Typ.	Max.	Unit
$t_{d(off)}$	Turn-off delay time	$V_{CC} = 400\text{ V}$ , $I_C = 20\text{ A}$ ,	-	121	-	ns
$t_f$	Current fall time	$V_{GE} = 15\text{ V}$ , $R_G = 22\ \Omega$ (see Figure 21. Test circuit for inductive load switching)	-	38	-	
$t_{d(off)}$	Turn-off delay time	$V_{CC} = 400\text{ V}$ , $I_C = 20\text{ A}$ ,	-	140	-	
$t_f$	Current fall time	$V_{GE} = 15\text{ V}$ , $R_G = 22\ \Omega$ , $T_J = 175\text{ }^\circ\text{C}$ (see Figure 21. Test circuit for inductive load switching)	-	90	-	

**Table 6. IGBT switching characteristics (capacitive load)**

Symbol	Parameter	Test conditions	Min.	Typ.	Max.	Unit
$E_{off}^{(1)}$	Turn-off switching energy	$V_{CC} = 320\text{ V}$ , $R_G = 10\ \Omega$ , $I_C = 20\text{ A}$ , $L = 100\ \mu\text{H}$ , $C_{snub} = 22\text{ nF}$ (see Figure 22. Test circuit for snubbed inductive load switching)	-	110	-	$\mu\text{J}$
		$V_{CC} = 320\text{ V}$ , $R_G = 10\ \Omega$ , $I_C = 20\text{ A}$ , $L = 100\ \mu\text{H}$ , $C_{snub} = 22\text{ nF}$ , $T_J = 175\text{ }^\circ\text{C}$ (see Figure 22. Test circuit for snubbed inductive load switching)	-	230	-	

1. Including the tail of the collector current.

## 2.1 Electrical characteristics (curves)

**Figure 1. Power dissipation vs case temperature**

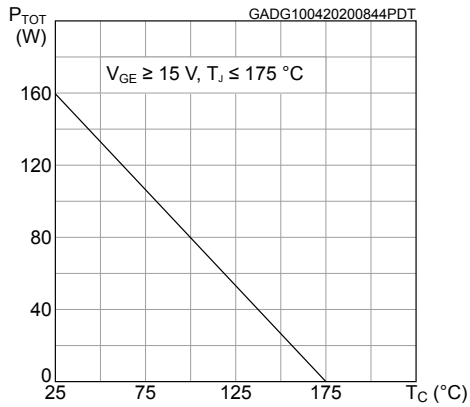

**Figure 2. Collector current vs case temperature**

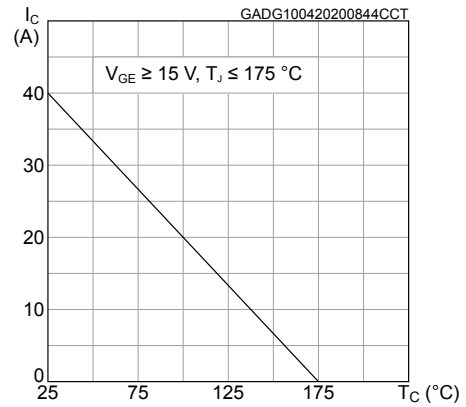

**Figure 3. Output characteristics ( $T_J = 25\text{ °C}$ )**

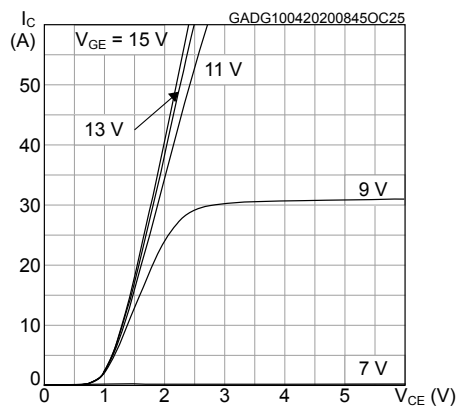

**Figure 4. Output characteristics ( $T_J = 175\text{ °C}$ )**

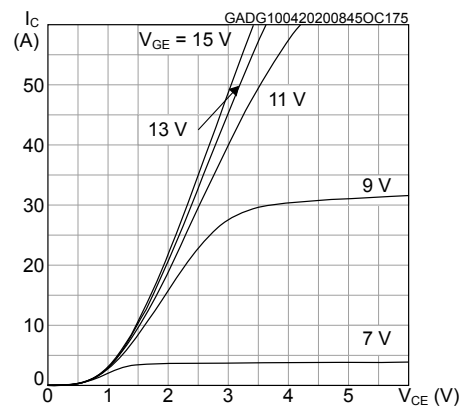

**Figure 5.  $V_{CE(sat)}$  vs junction temperature**

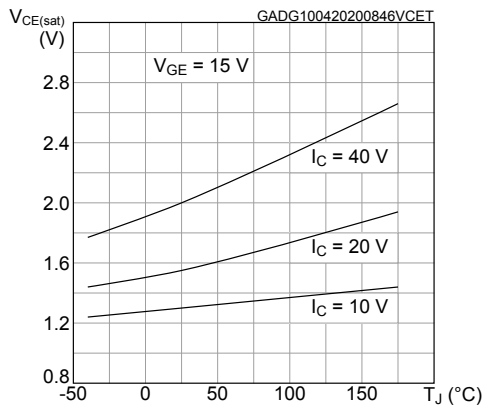

**Figure 6.  $V_{CE(sat)}$  vs collector current**

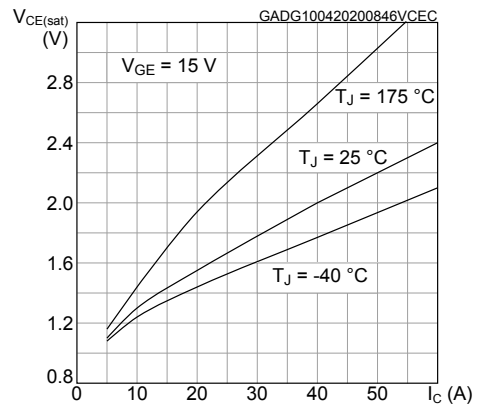

**Figure 7. Forward bias safe operating area**

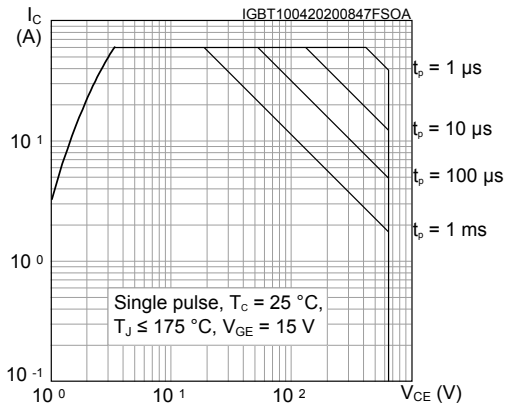

**Figure 8. Transfer characteristics**

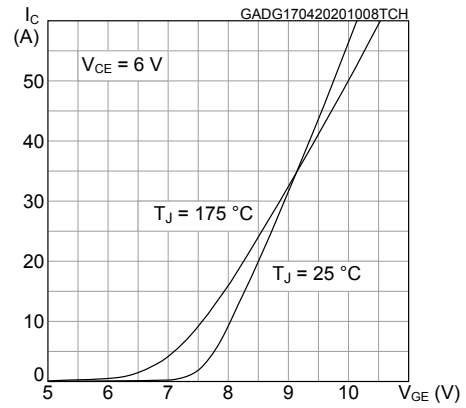

**Figure 9. Diode V\_F vs forward current**

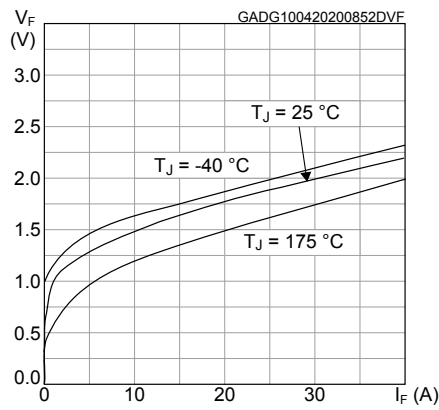

**Figure 10. Normalized V\_GE(th) vs junction temperature**

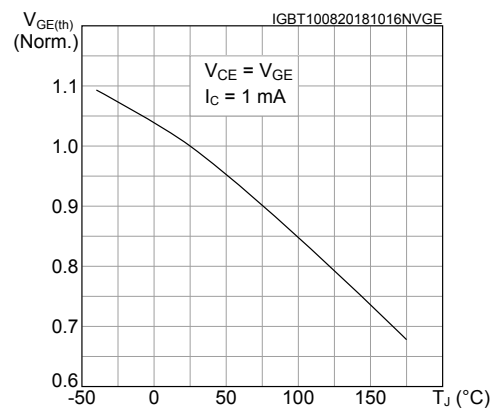

**Figure 11. Normalized V\_(BR)CES vs junction temperature**

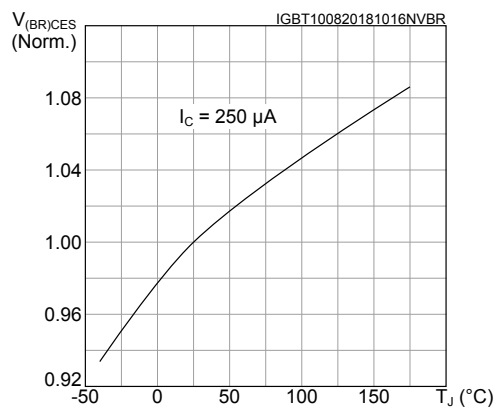

**Figure 12. Capacitance variations**

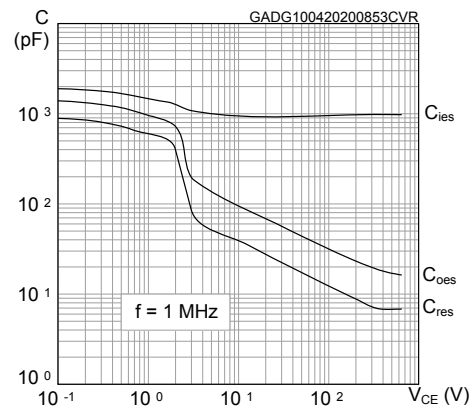

**Figure 13. Gate charge vs gate-emitter voltage**

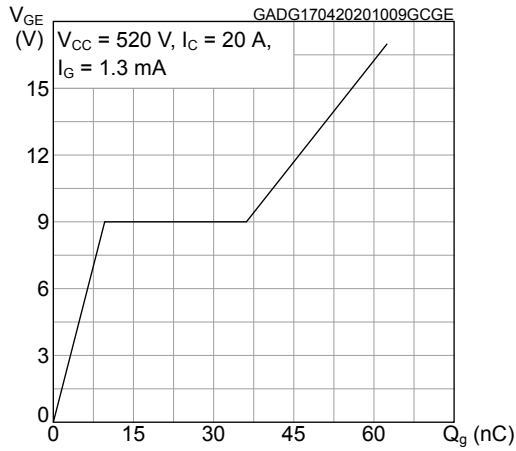

**Figure 14. Switching energy vs collector current**

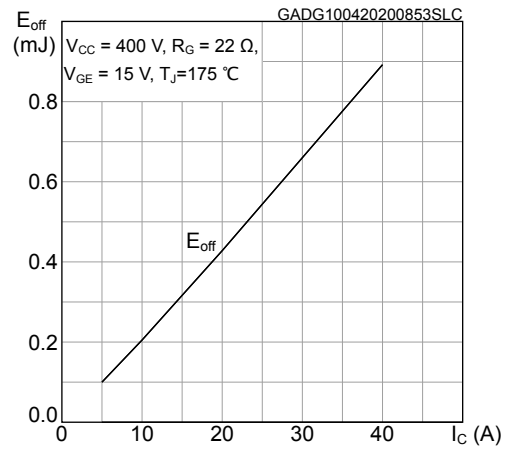

**Figure 15. Switching energy vs temperature**

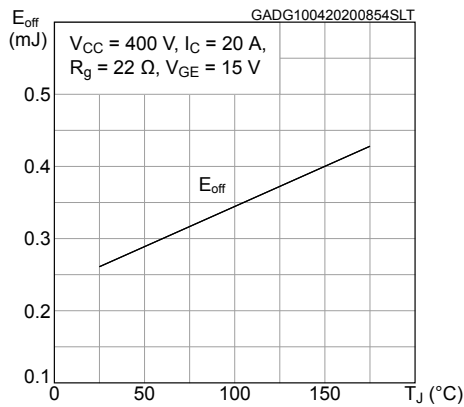

**Figure 16. Switching energy vs collector emitter voltage**

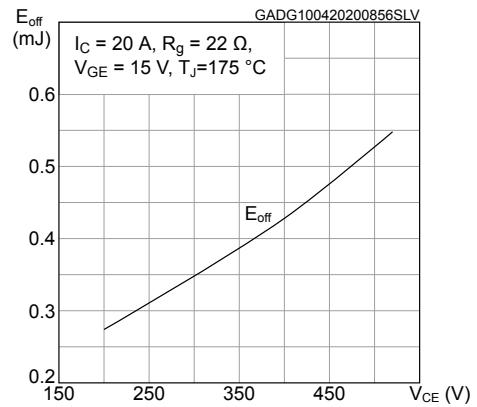

**Figure 17. Switching times vs collector current**

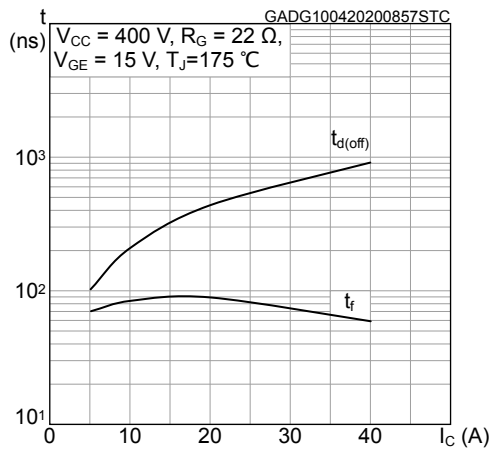

**Figure 18. Switching energy vs snubber capacitance**

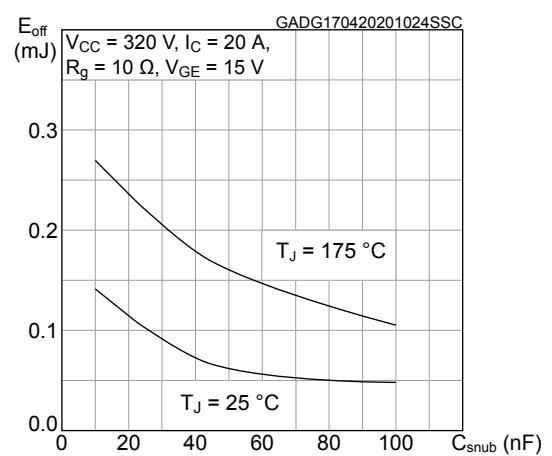

**Figure 19. Thermal impedance for IGBT**

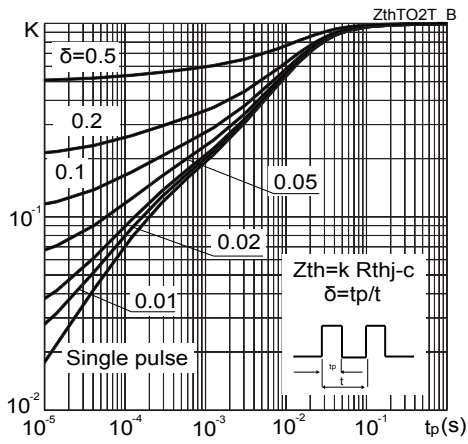

**Figure 20. Thermal impedance for diode**

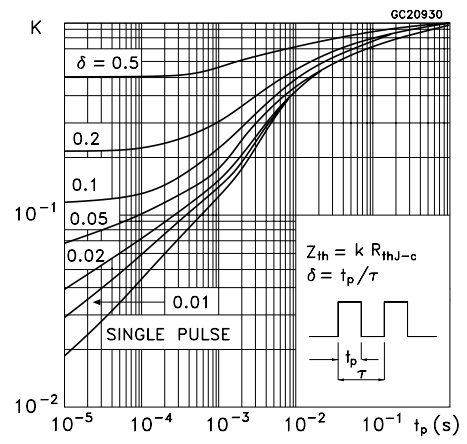



### 3 Test circuits

Figure 21. Test circuit for inductive load switching

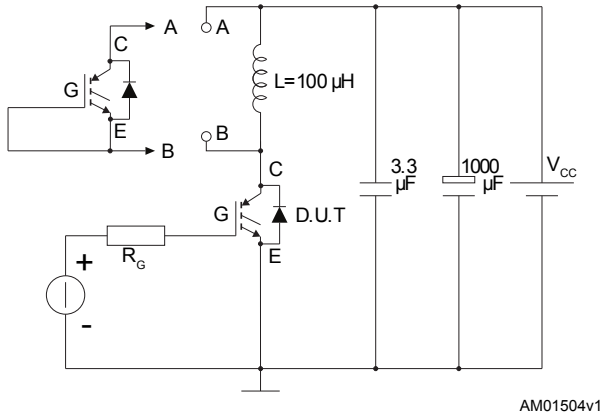

Figure 22. Test circuit for snubbed inductive load switching

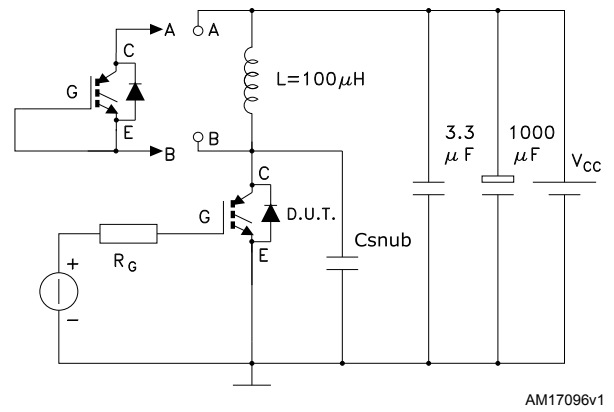

Figure 23. Gate charge test circuit

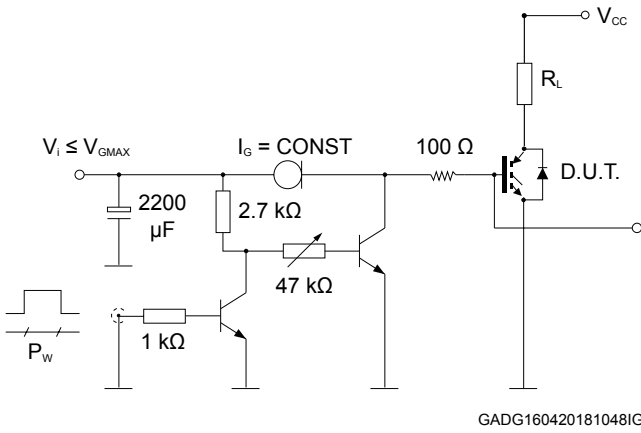
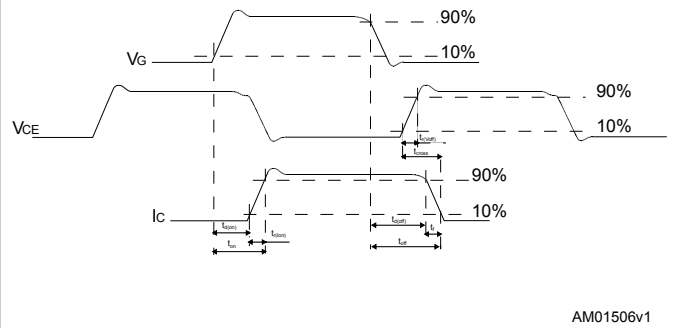

Figure 24. Switching waveform



## 4 Package information

In order to meet environmental requirements, ST offers these devices in different grades of **ECOPACK** packages, depending on their level of environmental compliance. ECOPACK specifications, grade definitions and product status are available at: [www.st.com](http://www.st.com). ECOPACK is an ST trademark.

### 4.1 TO-247 long leads package information

Figure 25. TO-247 long leads package outline

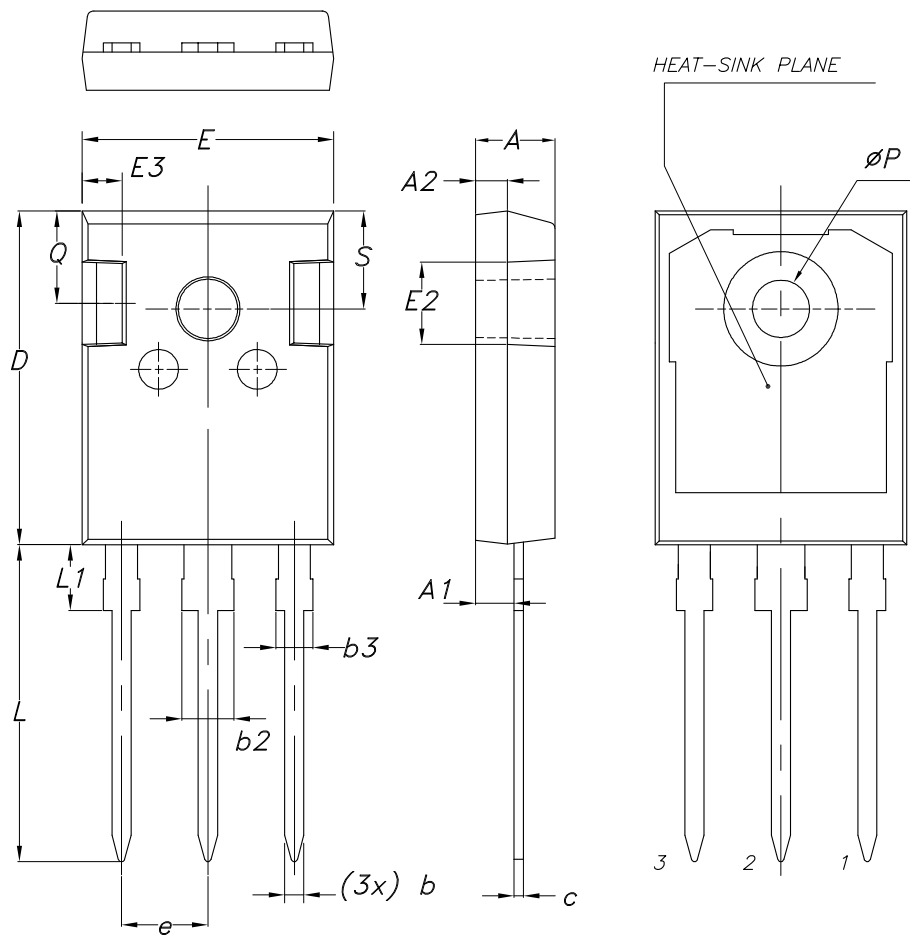

8463846\_2\_F

**Table 7. TO-247 long leads package mechanical data**

Dim.	mm		
	Min.	Typ.	Max.
A	4.90	5.00	5.10
A1	2.31	2.41	2.51
A2	1.90	2.00	2.10
b	1.16		1.26
b2			3.25
b3			2.25
c	0.59		0.66
D	20.90	21.00	21.10
E	15.70	15.80	15.90
E2	4.90	5.00	5.10
E3	2.40	2.50	2.60
e	5.34	5.44	5.54
L	19.80	19.92	20.10
L1			4.30
P	3.50	3.60	3.70
Q	5.60		6.00
S	6.05	6.15	6.25

## Revision history

**Table 8. Document revision history**

Date	Revision	Changes
15-Apr-2020	1	First release.

## Contents

<b>1</b>	<b>Electrical ratings</b> .....	<b>2</b>
<b>2</b>	<b>Electrical characteristics</b> .....	<b>3</b>
<b>2.1</b>	<b>Electrical characteristics (curves)</b> .....	<b>5</b>
<b>3</b>	<b>Test circuits</b> .....	<b>9</b>
<b>4</b>	<b>Package information</b> .....	<b>10</b>
<b>4.1</b>	<b>TO-247 long leads package information</b> .....	<b>10</b>
	<b>Revision history</b> .....	<b>12</b>

**IMPORTANT NOTICE – PLEASE READ CAREFULLY**

STMicroelectronics NV and its subsidiaries (“ST”) reserve the right to make changes, corrections, enhancements, modifications, and improvements to ST products and/or to this document at any time without notice. Purchasers should obtain the latest relevant information on ST products before placing orders. ST products are sold pursuant to ST’s terms and conditions of sale in place at the time of order acknowledgement.

Purchasers are solely responsible for the choice, selection, and use of ST products and ST assumes no liability for application assistance or the design of Purchasers’ products.

No license, express or implied, to any intellectual property right is granted by ST herein.

Resale of ST products with provisions different from the information set forth herein shall void any warranty granted by ST for such product.

ST and the ST logo are trademarks of ST. For additional information about ST trademarks, please refer to [www.st.com/trademarks](http://www.st.com/trademarks). All other product or service names are the property of their respective owners.

Information in this document supersedes and replaces information previously supplied in any prior versions of this document.

© 2020 STMicroelectronics – All rights reserved