

# TPS2596 2.7 to 19 V, 0.125 to 2-A, 89-mΩ eFuse With Accurate Current Monitor and Fast Overvoltage Protection

## 1 Features

- Wide input voltage range: 2.7-V to 19-V
  - 21-V Absolute maximum
- Low On-Resistance:  $R_{on} = 89\text{-m}\Omega$  (typical)
- Active high enable input with adjustable undervoltage lockout (UVLO)
- Overvoltage protection options available:
  - Fast overvoltage clamp (3.8-V, 5.7-V and 13.8-V pin-selectable thresholds) with a response time of 5- $\mu\text{s}$  (typical)
  - Adjustable overvoltage lockout (OVLO) with a response time of 1.3- $\mu\text{s}$  (typical)
- Adjustable current limit with load current monitor output (ILM)
  - Current range: 0.125-A to 2-A
  - Current limit accuracy:
    - $\pm 10.4\%$  (maximum) across current range
    - $\pm 5.5\%$  (maximum) at 1-A current limit
- Immune to Electrical Fast Transients (IEC 61000-4-4)
- Adjustable output slew rate control (dVdt)
- Overtemperature protection (OTP)
- Fault indication pin ( $\overline{\text{FLT}}$ )
- UL 2367 recognition (pending)
- IEC 62368 CB certification (pending)
- Small footprint: 4.91 mm x 3.9 mm SOIC package

## 2 Applications

- Energy meters
- UL 60335-1 15-W LPC in Appliances
  - Refrigerators
  - Dishwashers
  - Washing machine and dryers
- Set-top boxes
- IP Network cameras

Simplified Schematic

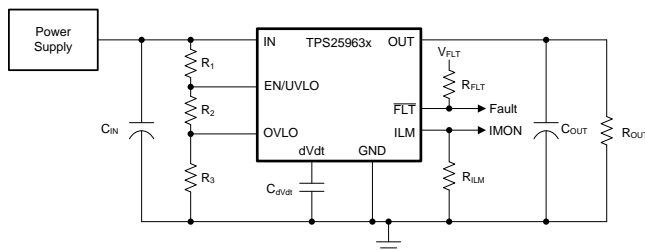

## 3 Description

The TPS2596xx family of *eFuses* (integrated FET hot-swap devices) is a highly integrated circuit protection and power management solution in a small package. The devices provide multiple protection modes using very few external components and are a robust defense against overloads, short circuits, voltage surges, and excessive inrush current. Output current limit level can be set with a single external resistor. It is also possible to get an accurate sense of the output load current by measuring the voltage drop across the current limit resistor. Applications with particular inrush current requirements can set the output slew rate with a single external capacitor. For the TPS25962x variants, in case of an input overvoltage condition, internal clamping circuits limit the output to a safe fixed maximum voltage (pin selectable), with no external components. The TPS25963x variants provide an option to set a user-defined overvoltage cutoff threshold.

The devices are characterized for operation over a junction temperature range of  $-40\text{ }^{\circ}\text{C}$  to  $+125\text{ }^{\circ}\text{C}$ .

Device Information<sup>(1)</sup>

PART NUMBER	PACKAGE	BODY SIZE (NOM)
TPS259620DDA	SOIC (8)	4.91 mm x 3.9 mm
TPS259621DDA	SOIC (8)	4.91 mm x 3.9 mm
TPS259630DDA	SOIC (8)	4.91 mm x 3.9 mm
TPS259631DDA	SOIC (8)	4.91 mm x 3.9 mm

(1) For all available packages, see the orderable addendum at the end of the data sheet.

TPS25963x 1KV EFT Response

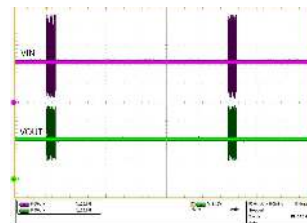

## Table of Contents

<b>1 Features</b> .....	1	8.4 Device Functional Modes.....	25
<b>2 Applications</b> .....	1	<b>9 Application and Implementation</b> .....	27
<b>3 Description</b> .....	1	9.1 Application Information.....	27
<b>4 Revision History</b> .....	2	9.2 Typical Application .....	27
<b>5 Device Comparison Table</b> .....	3	9.3 System Examples .....	31
<b>6 Pin Configuration and Functions</b> .....	4	<b>10 Power Supply Recommendations</b> .....	34
<b>7 Specifications</b> .....	5	10.1 Transient Protection .....	34
7.1 Absolute Maximum Ratings .....	5	10.2 Output Short-Circuit Measurements .....	35
7.2 ESD Ratings.....	5	<b>11 Layout</b> .....	36
7.3 Recommended Operating Conditions.....	5	11.1 Layout Guidelines .....	36
7.4 Thermal Information .....	6	11.2 Layout Example .....	37
7.5 Electrical Characteristics.....	6	<b>12 Device and Documentation Support</b> .....	38
7.6 Timing Requirements.....	8	12.1 Documentation Support .....	38
7.7 Switching Characteristics .....	8	12.2 Receiving Notification of Documentation Updates	38
7.8 Typical Characteristics .....	10	12.3 Community Resources.....	38
<b>8 Detailed Description</b> .....	17	12.4 Trademarks .....	38
8.1 Overview .....	17	12.5 Electrostatic Discharge Caution.....	38
8.2 Functional Block Diagram .....	17	12.6 Glossary .....	38
8.3 Feature Description.....	18	<b>13 Mechanical, Packaging, and Orderable Information</b> .....	38

## 4 Revision History

Changes from Original (May 2019) to Revision A	Page
• Change from Advance Information to Production Data .....	1

## 5 Device Comparison Table

Part Number	Overvoltage Response	Response to Thermal Shutdown (TSD)
TPS259620	OVC - 3.8 V, 5.7 V, 13.8 V (Pin Selectable)	Latch-off
TPS259621	OVC - 3.8 V, 5.7 V, 13.8 V (Pin Selectable)	Auto-retry
TPS259630	Adjustable OVLO	Latch-off
TPS259631	Adjustable OVLO	Auto-retry

## 6 Pin Configuration and Functions

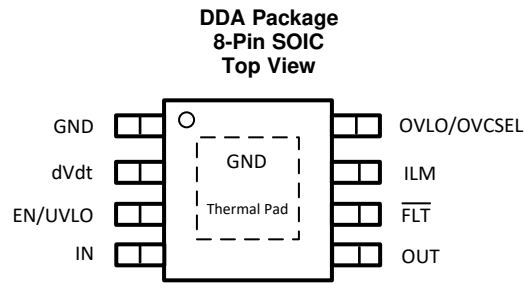

### Pin Functions

PIN		I/O	DESCRIPTION
NAME	NO.		
GND	1	Ground	Ground
dVdt	2	Analog Output	A capacitor from this pin to GND sets the output turn on slew rate. Leave this pin floating for the fastest turn on slew rate.
EN/UVLO	3	Analog Input	Active High Enable for the Device. A resistor divider can be used to adjust the Undervoltage Lockout threshold. <b>Do not leave floating.</b>
IN	4	Power	Power Input
OUT	5	Power	Power Output
$\overline{\text{FLT}}$	6	Digital Output	Active Low indicator which will be pulled low when a fault is detected. It is an open-drain output that requires an external pull-up resistance.
ILM	7	Analog Output	This is a dual function pin used to limit and monitor the output current. An external resistor from this pin to GND sets the output current limit. The pin voltage can also be used to monitor the output load current.
OVLO	8	Analog Input	<b>TPS25963x:</b> A resistor divider can be used to adjust the Overvoltage Lockout threshold. <b>Do not leave floating.</b>
OVCSEL			<b>TPS25962x:</b> Overvoltage Clamp level select pin. Refer to <a href="#">Overvoltage Clamp</a> for more details.
Thermal pad		Ground	The Exposed Pad is used primarily for heat dissipation and must be connected to system ground plane for best thermal performance.

## 7 Specifications

### 7.1 Absolute Maximum Ratings

over operating free-air temperature range (unless otherwise noted)<sup>(1)</sup>

PARAMETER		PIN	MIN	MAX	UNITS
V <sub>IN</sub>	Maximum Input Voltage Range	IN	-0.3	21	V
	Maximum Input Voltage Range (T <sub>A</sub> = 25 °C)			22	V
V <sub>OUT</sub>	Maximum Output Voltage Range	OUT	-0.3	min (21, V <sub>IN</sub> + 0.3)	V
V <sub>EN/UVLO</sub>	Maximum Enable Pin Voltage Range	EN/UVLO	-0.3	7	V
V <sub>OV</sub>	Maximum OVCSEL/OVLO Pin Voltage Range	OVCSEL/OVLO	-0.3	7	V
V <sub>dVdT</sub>	Maximum dVdT Pin Voltage Range	DVDT		2.5	V
V <sub>FLTB</sub>	Maximum FLTB Pin Voltage Range	$\overline{\text{FLT}}$	-0.3	7	V
I <sub>FLTB</sub>	Maximum FLTB Pin Sink Current	$\overline{\text{FLT}}$		10	mA
I <sub>MAX</sub>	Maximum Continuous Switch Current	IN to OUT	Internally Limited		A
T <sub>J</sub>	Junction temperature		Internally Limited		°C
T <sub>LEAD</sub>	Maximum Lead Temperature			300	°C
T <sub>stg</sub>	Storage temperature		-65	150	°C

- (1) Stresses beyond those listed under *Absolute Maximum Rating* may cause permanent damage to the device. These are stress ratings only, which do not imply functional operation of the device at these or any other conditions beyond those indicated under *Recommended Operating Condition*. Exposure to absolute-maximum-rated conditions for extended periods may affect device reliability.

### 7.2 ESD Ratings

			VALUE	UNIT
V <sub>(ESD)</sub>	Electrostatic discharge	Human body model (HBM), per ANSI/ESDA/JEDEC JS-001, all pins <sup>(1)</sup>	±2000	V
		Charged device model (CDM), per JEDEC specification JESD22-C101, all pins <sup>(2)</sup>	±500	

- (1) JEDEC document JEP155 states that 500-V HBM allows safe manufacturing with a standard ESD control process.  
(2) JEDEC document JEP157 states that 250-V CDM allows safe manufacturing with a standard ESD control process.

### 7.3 Recommended Operating Conditions

over operating free-air temperature range (unless otherwise noted)

PARAMETER		PIN	MIN	MAX	UNITS
V <sub>IN</sub>	Input Voltage Range	IN	2.7	19 <sup>(1)</sup>	V
V <sub>OUT</sub>	Output Voltage Range	OUT		V <sub>IN</sub> + 0.3	V
V <sub>EN/UVLO</sub>	Enable Pin Voltage Range	EN/UVLO		6 <sup>(2)</sup>	V
V <sub>OV</sub>	OVLO Pin Voltage Range (TPS25963x Only)	OVLO	0.5	2	V
V <sub>dVdT</sub>	dVdT Pin Capacitor Voltage Rating	DVDT	4		V
V <sub>FLTB</sub>	FLTB Pin Voltage Range	$\overline{\text{FLT}}$		6	V
R <sub>ILM</sub>	ILM Pin Resistance	ILM	453	7869	Ω
I <sub>MAX</sub>	Continuous Switch Current	IN to OUT		2	A
T <sub>J</sub>	Junction temperature		-40	125	°C

- (1) For TPS25962x, the input voltage should be limited to the selected Output Voltage Clamp Option as listed in the Electrical Characteristics section  
(2) For supply voltages below 6V, it is okay to pull up the EN pin to IN through a resistor of 100 kΩ or higher. For supply voltages greater than 6V, it is recommended to use an appropriate resistor divider between IN, EN and GND to ensure the voltage at the EN pin is within the specified limits.

## 7.4 Thermal Information

THERMAL METRIC <sup>(1)</sup>		TPS2596X	
		DDA (SOIC-EP)	
		8 PINS	
			UNIT
$R_{\theta JA}$	Junction-to-ambient thermal resistance	52.7 <sup>(2)</sup>	°C/W
$R_{\theta JA}$	Junction-to-ambient thermal resistance	119.8 <sup>(3)</sup>	°C/W
$\Psi_{JT}$	Junction-to-top characterization parameter	8.9 <sup>(2)</sup>	°C/W
$\Psi_{JT}$	Junction-to-top characterization parameter	17.5 <sup>(3)</sup>	°C/W
$\Psi_{JB}$	Junction-to-board characterization parameter	27.1 <sup>(2)</sup>	°C/W
$\Psi_{JB}$	Junction-to-board characterization parameter	68.1 <sup>(3)</sup>	°C/W

(1) For more information about traditional and new thermal metrics, see the [Semiconductor and IC Package Thermal Metrics](#) application report.

(2) With exposed pad soldered to PCB

(3) Without exposed pad soldered to PCB

## 7.5 Electrical Characteristics

(Test conditions unless otherwise noted)  $-40^{\circ}\text{C} \leq T_J \leq 125^{\circ}\text{C}$ ,  $V_{IN} = 12\text{ V}$ ,  $R_{ILM} = 453\ \Omega$ ,  $C_{dvdT} = \text{Open}$ ,  $\text{OUT} = \text{Open}$ . All voltages referenced to GND.

PARAMETER		TEST CONDITIONS	MIN	TYP	MAX	UNITS
<b>INPUT SUPPLY (IN)</b>						
$I_Q$	IN quiescent current	TPS25963x		193	259	$\mu\text{A}$
		TPS25962x		206	266	$\mu\text{A}$
$I_{SD}$	IN Shutdown Current	$V_{IN} < 4\text{ V}$ , $V_{EN/UVLO} < V_{SD}$			0.1	$\mu\text{A}$
		$V_{IN} \geq 4\text{ V}$ , $V_{EN/UVLO} < V_{SD}$		0.4	1.132	$\mu\text{A}$
$V_{UVP(R)}$	IN Undervoltage Protection threshold	$V_{IN}$ Rising	2.46	2.53	2.58	V
$V_{UVP(F)}$		$V_{IN}$ Falling	2.36	2.42	2.46	V
	IN Undervoltage Protection Hysteresis			110		mV
<b>OUTPUT VOLTAGE CLAMP (OUT) - TPS25962X</b>						
$V_{OVC}$	Overvoltage Clamp Threshold	$R_{OVCSEL} = \text{Short to GND}$ , $R_{OUT} = 10\ \text{K}\Omega$	3.75	3.83	3.92	V
		$R_{OVCSEL} = 400\ \text{K}\Omega$ to GND, $R_{OUT} = 10\ \text{K}\Omega$	5.54	5.69	5.83	V
		$R_{OVCSEL} = \text{OPEN}$ , $R_{OUT} = 10\ \text{K}\Omega$	12.97	13.77	14.52	V
$V_{CLAMP}$	Output Voltage During Clamping	$R_{OVCSEL} = \text{Short to GND}$ , $I_{OUT} = 10\ \text{mA}$	3.47	3.59	3.7	V
		$R_{OVCSEL} = 400\ \text{K}\Omega$ to GND, $I_{OUT} = 10\ \text{mA}$	5.28	5.45	5.61	V
		$R_{OVCSEL} = \text{OPEN}$ , $I_{OUT} = 10\ \text{mA}$	13.13	13.58	13.97	V
<b>OUTPUT CURRENT LIMIT AND MONITOR (ILM)</b>						
$G_{IMON}$	Current monitor gain as measured on ILM pin ( $I_{ILM} / I_{OUT}$ )	$I_{OUT} = 0.13\ \text{A}$	531.22	653.21	800.00	$\mu\text{A}/\text{A}$
		$I_{OUT} = 2\ \text{A}$	635.77	657.15	684.05	$\mu\text{A}/\text{A}$
$I_{ILM}$	$I_{OUT}$ Current Limit	$R_{ILM} = 7.87\ \text{K}\Omega$ , $V_{DS} = 0.5\ \text{V}$ , $-40^{\circ}\text{C} \leq T_A \leq 80^{\circ}\text{C}$	0.113	0.125	0.139	A
		$R_{ILM} = 3.83\ \text{K}\Omega$ , $V_{DS} = 0.5\ \text{V}$	0.224	0.247	0.269	A
		$R_{ILM} = 909\ \Omega$ , $V_{DS} = 0.5\ \text{V}$	0.949	1.005	1.051	A
		$R_{ILM} = 453\ \Omega$ , $V_{DS} = 0.5\ \text{V}$	1.83	2.004	2.147	A
		$R_{ILM} = \text{OPEN}$		0		A
$I_{CB}$	$I_{OUT}$ Circuit Breaker Threshold during $R_{ILM}$ Short condition	$R_{ILM} = \text{Short to GND}$ (Single Point Failure Test IEC 62368-1)			1.5	A

## Electrical Characteristics (continued)

(Test conditions unless otherwise noted)  $-40^{\circ}\text{C} \leq T_J \leq 125^{\circ}\text{C}$ ,  $V_{\text{IN}} = 12\text{ V}$ ,  $R_{\text{ILM}} = 453\ \Omega$ ,  $C_{\text{dVdT}} = \text{Open}$ ,  $\text{OUT} = \text{Open}$ . All voltages referenced to GND.

PARAMETER		TEST CONDITIONS	MIN	TYP	MAX	UNITS	
<b>ON-RESISTANCE (IN TO OUT)</b>							
$R_{\text{ON}}$	ON State Resistance	$V_{\text{IN}} < 4\text{ V}$ , $I_{\text{OUT}} = 0.2\text{ A}$ , $T_J = 25^{\circ}\text{C}$		97	99.8	m $\Omega$	
		$V_{\text{IN}} < 4\text{ V}$ , $I_{\text{OUT}} = 0.2\text{ A}$ , $T_J = -40\text{ to }85^{\circ}\text{C}$			125.4	m $\Omega$	
		$V_{\text{IN}} < 4\text{ V}$ , $I_{\text{OUT}} = 0.2\text{ A}$ , $T_J = -40\text{ to }125^{\circ}\text{C}$				143.4	m $\Omega$
		$V_{\text{IN}} > 4\text{ V}$ , $I_{\text{OUT}} = 0.2\text{ A}$ , $T_J = 25^{\circ}\text{C}$		89	92.6	m $\Omega$	
		$V_{\text{IN}} > 4\text{ V}$ , $I_{\text{OUT}} = 0.2\text{ A}$ , $T_J = -40\text{ to }85^{\circ}\text{C}$				115.3	m $\Omega$
		$V_{\text{IN}} > 4\text{ V}$ , $I_{\text{OUT}} = 0.2\text{ A}$ , $T_J = -40\text{ to }125^{\circ}\text{C}$				131	m $\Omega$
<b>ENABLE/UNDERVOLTAGE LOCK OUT (EN/UVLO)</b>							
$V_{\text{UVLO(R)}}$	UVLO Threshold	$V_{\text{EN}}$ Rising	1.18	1.2	1.22	V	
$V_{\text{UVLO(F)}}$		$V_{\text{EN}}$ Falling	1.08	1.1	1.13	V	
	UVLO Hysteresis			95		mV	
$V_{\text{SD}}$	$V_{\text{EN}}$ threshold for lowest shutdown current	$V_{\text{EN}}$ Falling	0.53		1.05	V	
$I_{\text{ENLKG}}$	EN leakage current		-0.1		0.1	$\mu\text{A}$	
<b>OVERVOLTAGE LOCKOUT (OVLO) - TPS25963X</b>							
$V_{\text{OVLO(R)}}$	OVLO Threshold	$V_{\text{OVLO}}$ Rising	1.17	1.2	1.22	V	
$V_{\text{OVLO(F)}}$		$V_{\text{OVLO}}$ Falling	1.08	1.1	1.13	V	
	OVLO Hysteresis			95		mV	
$I_{\text{OVLKG}}$	OVLO pin leakage current	$0.5 \leq V_{\text{OVLO}} \leq 1.5\text{ V}$	-0.1		0.1	$\mu\text{A}$	
<b>FAULT INDICATION (FLT)</b>							
$R_{\text{FLTb}}$	$\overline{\text{FLT}}$ Internal Pull-down resistance	$\overline{\text{FLT}}$ asserted		11.52		$\Omega$	
$I_{\text{FLTLKG}}$	$\overline{\text{FLT}}$ pin leakage current	$\overline{\text{FLT}}$ de-asserted, pull-up voltage 6 V	-1		1	$\mu\text{A}$	
<b>OVERTEMPERATURE PROTECTION (OTP)</b>							
TSD	Thermal Shutdown Rising Threshold	$T_J$ Rising		157		$^{\circ}\text{C}$	
TSD <sub>HYS</sub>	Thermal Shutdown Hysteresis	$T_J$ Falling		11.5		$^{\circ}\text{C}$	
<b>DVDT</b>							
$I_{\text{DVDT}}$	dVdt Pin Charging Current		1.89	2.11	2.33	$\mu\text{A}$	
$G_{\text{DVDT}}$	DVDT gain		20.31	20.93	21.5	V	

## 7.6 Timing Requirements

Typical Values are taken at  $T_J = 25^\circ\text{C}$  unless specifically noted otherwise.

PARAMETER	TEST CONDITIONS	MIN	TYP	MAX	UNITS
$t_{LIM}$	Current limit response time $I_{OUT} > 20\%$ over $I_{LIM}$ to $I_{OUT} \leq I_{LIM}$		87		$\mu\text{s}$
$t_{SC}$	Short circuit response time $V_{OUT} \downarrow$ to $I_{OUT} \leq I_{LIM}$		5		$\mu\text{s}$
$t_{OVLO}$	Overvoltage lockout response time TPS25963x Only		1.3		$\mu\text{s}$
$t_{OVC}$	Output clamp response time TPS25962x Only , $I_{OUT} = 2\text{ A}$		5		$\mu\text{s}$
$t_{TSD,RST}$	Thermal Shutdown Auto-Retry Interval TPS2596x1 Only		95		ms

## 7.7 Switching Characteristics

The output rising slew rate is internally controlled and constant across the entire operating voltage range to ensure the turn-on timing is not affected by the load conditions. The rising slew rate can be adjusted by adding capacitance from the dVdt pin to ground. As  $C_{dVdt}$  is increased, it will slow the rising slew rate (SR). See Slew Rate and Inrush Current Control (dVdt) section for more details. The fall time, however, is dependent on the RC time constant of the load capacitance ( $C_{OUT}$ ) and Load Resistance ( $R_L$ ). The Switching Characteristics are only valid for the power-up sequence where the supply is available in steady state condition and the load voltage is completely discharged before the device is enabled. Typical Values are taken at  $T_J = 25^\circ\text{C}$  unless specifically noted otherwise.  $R_{OUT} = 100\ \Omega$ ,  $C_{OUT} = 1\ \mu\text{F}$ .

PARAMETER		$V_{IN}$	$C_{dVdt} = \text{Open}$	$C_{dVdt} = 3300\text{pF}$	UNIT
$SR_{ON}$	Output Rising slew rate	2.7 V	28.9	12.1	V/ms
		5 V	42.7	13.1	
		12 V	75.1	13.6	
$t_{D,ON}$	Turn on delay	2.7 V	77.5	216.5	$\mu\text{s}$
		5 V	78.9	247.3	
		12 V	82.9	314.9	
$t_R$	Rise time	2.7 V	74.7	182.4	$\mu\text{s}$
		5 V	94.1	311.0	
		12 V	128.4	707.8	
$t_{ON}$	Turn on time	2.7 V	152.2	398.9	$\mu\text{s}$
		5 V	173	558.4	
		12 V	211.3	1022.7	
$t_{D,OFF}$	Turn off delay	2.7 V	12.2	12.3	$\mu\text{s}$
		5 V	11.6	11.9	
		12 V	10.3	10.4	



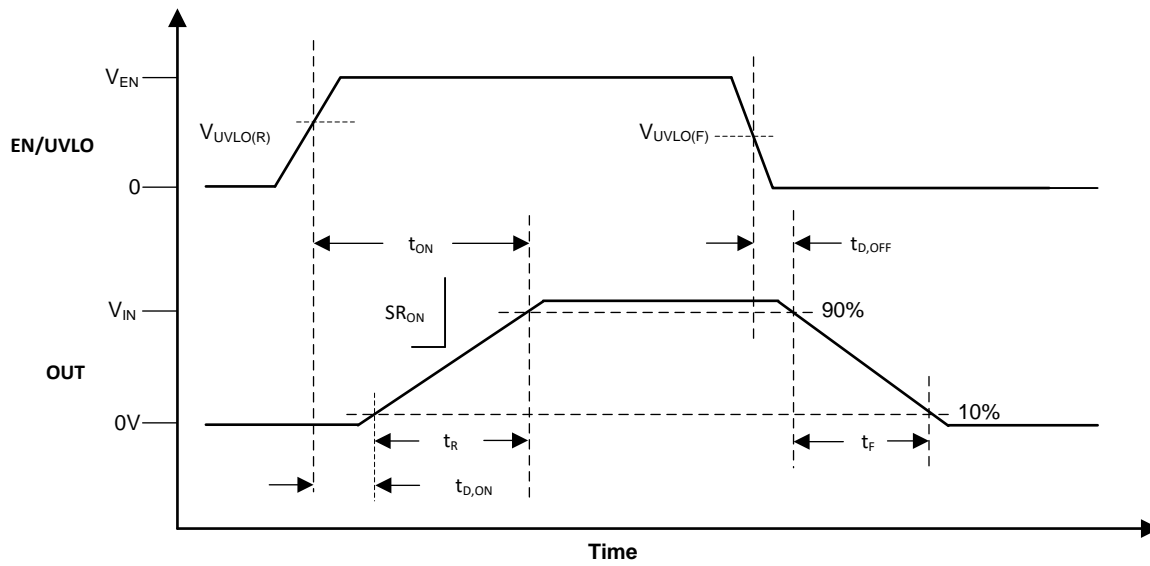

Figure 1. TPS2596xx Switching Times

## 7.8 Typical Characteristics

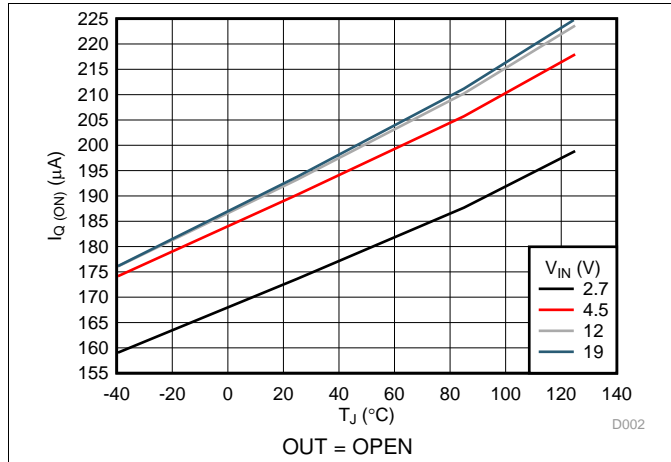

Figure 2. TPS25963x Quiescent Current

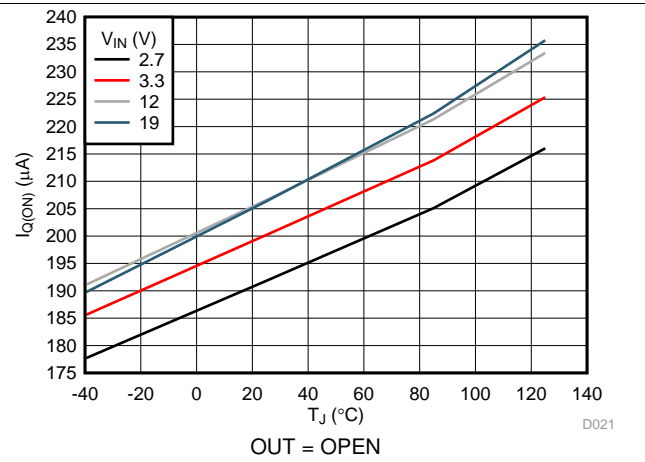

Figure 3. TPS25962x Quiescent Current

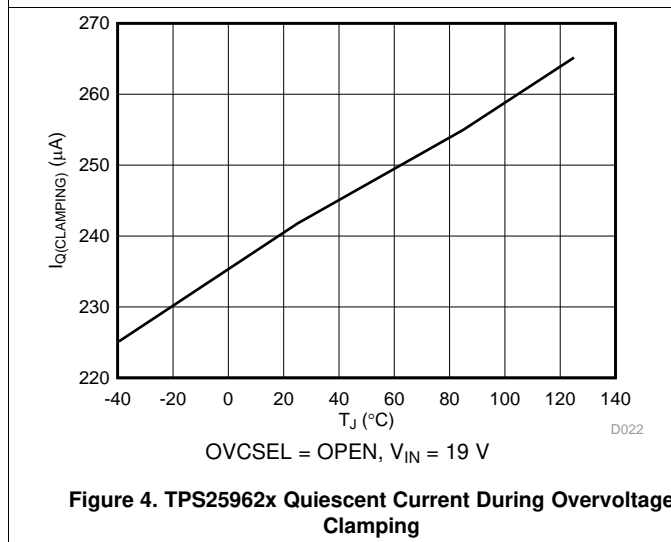

Figure 4. TPS25962x Quiescent Current During Overvoltage Clamping

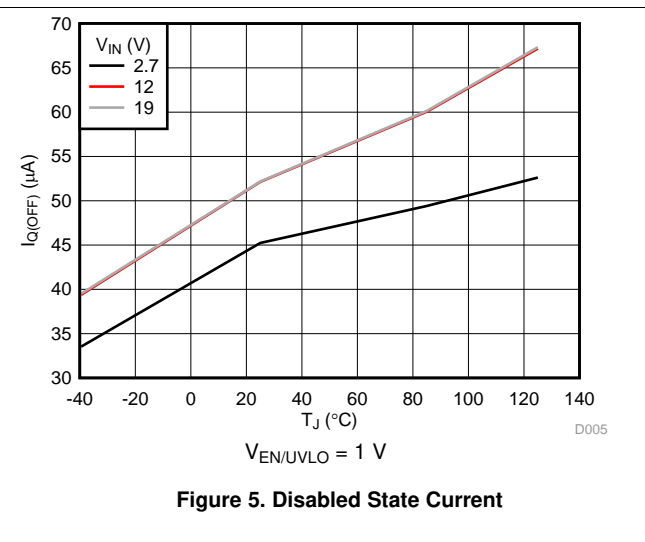

Figure 5. Disabled State Current

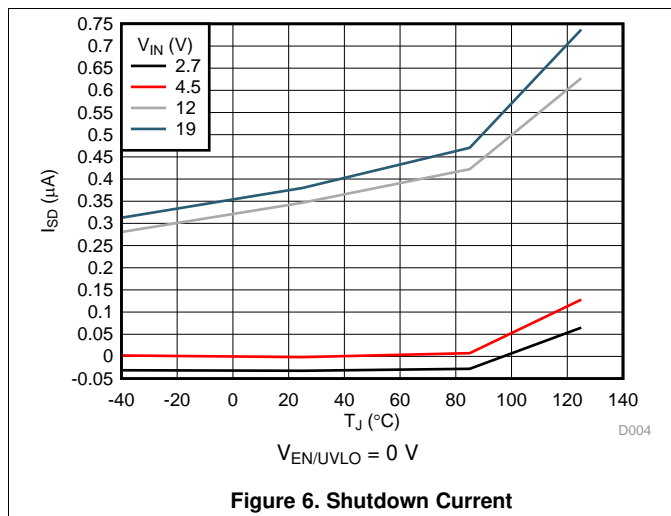

Figure 6. Shutdown Current

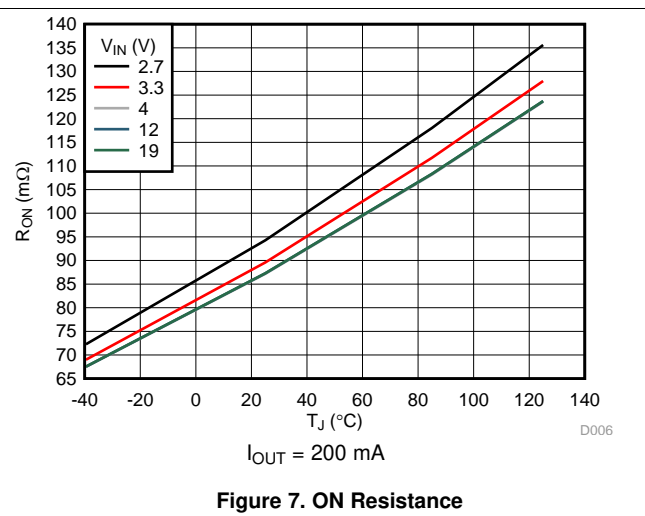
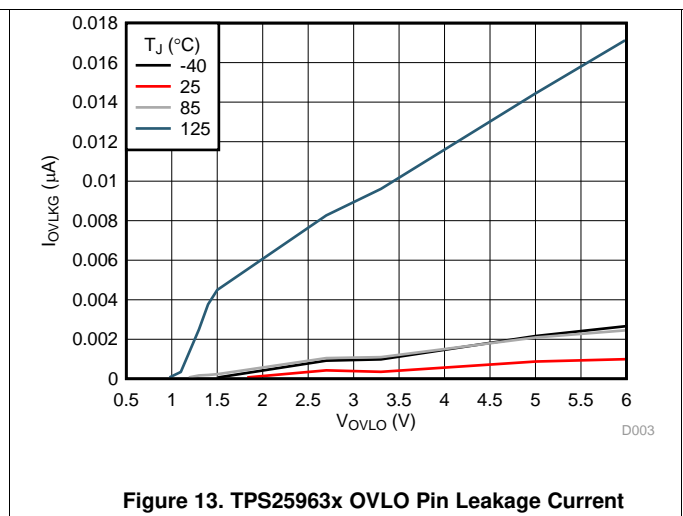
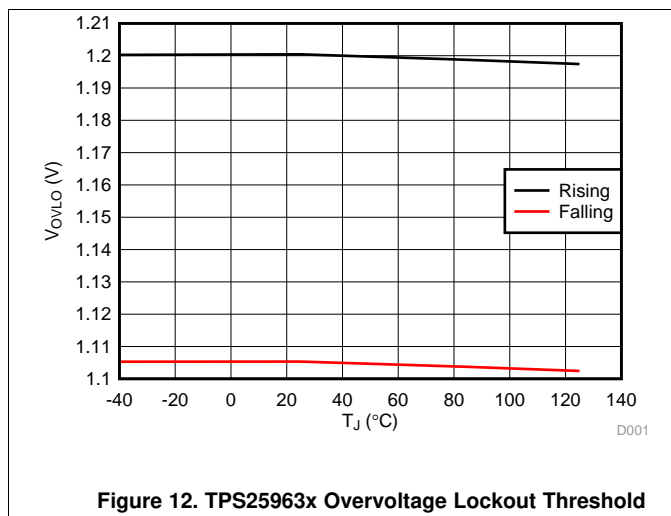
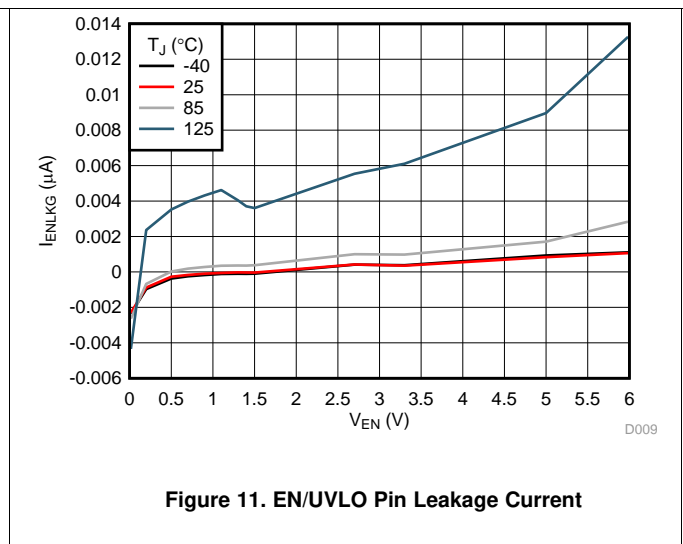
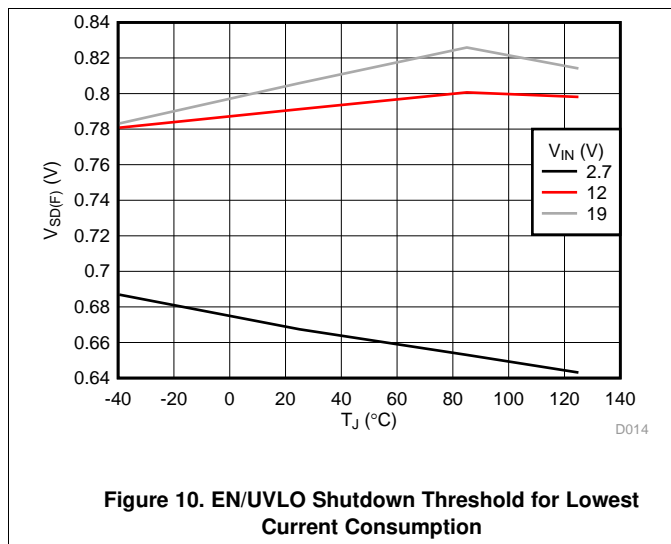
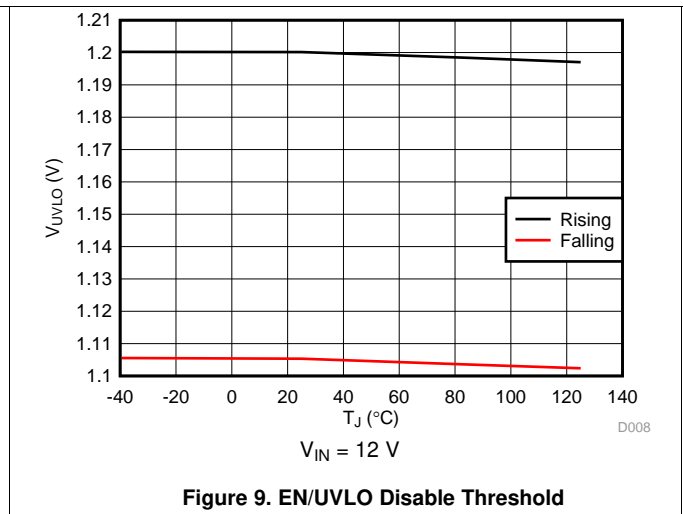
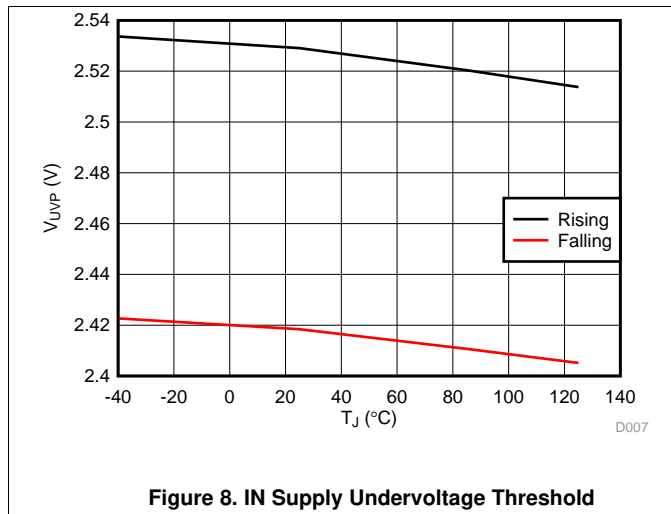
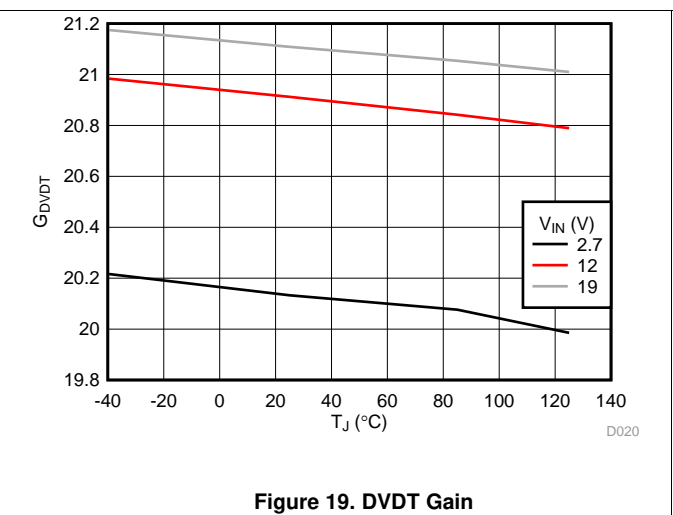
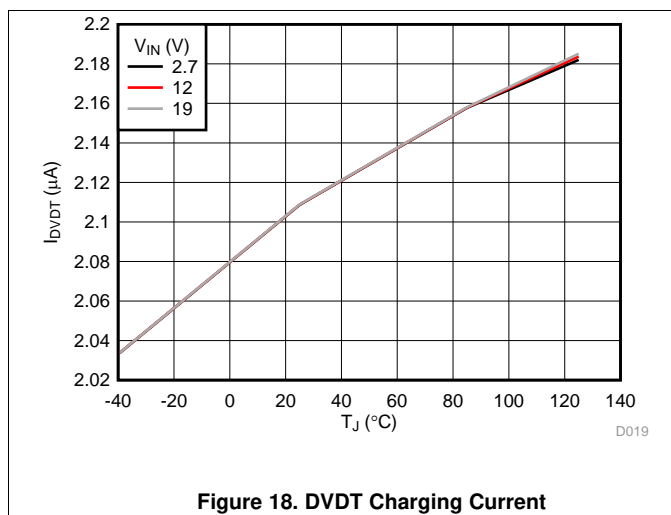
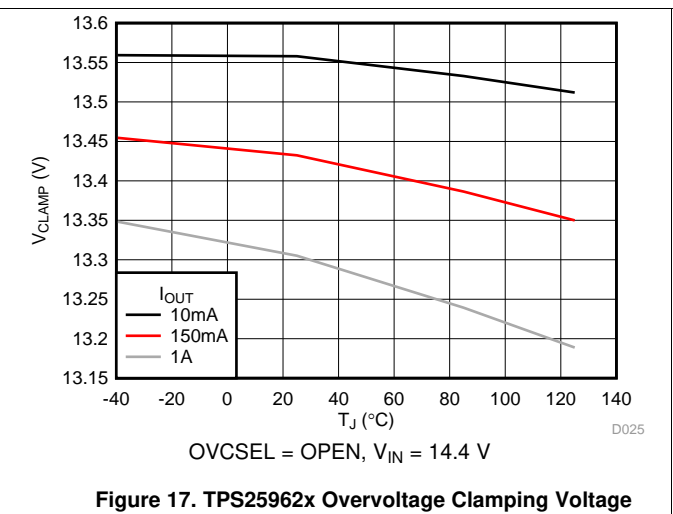
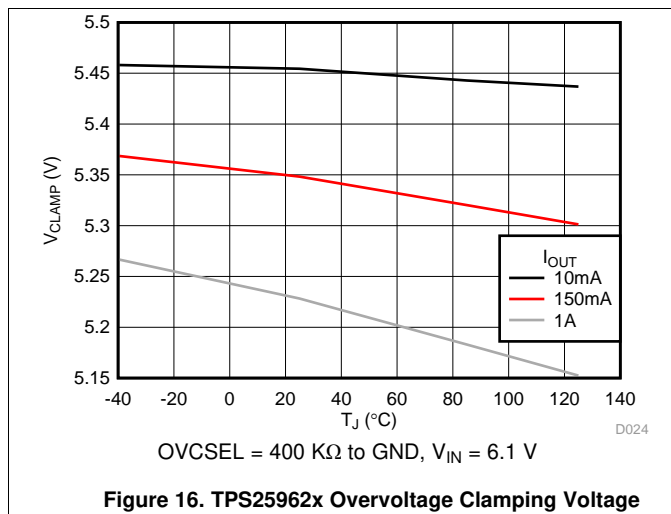
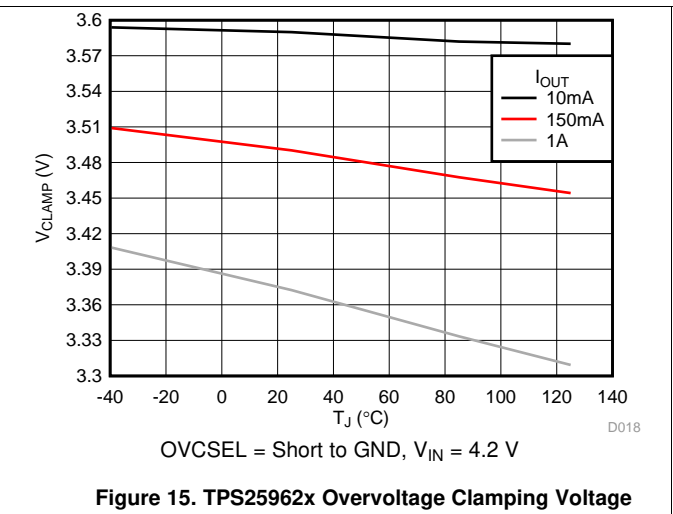
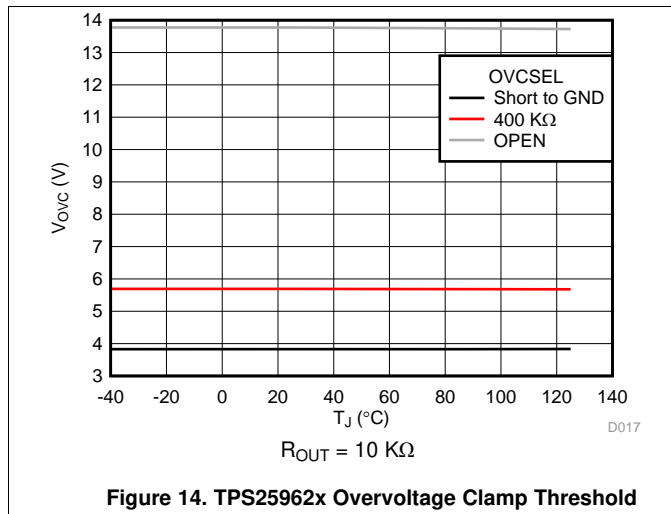

Figure 7. ON Resistance

Typical Characteristics (continued)



Typical Characteristics (continued)



Typical Characteristics (continued)

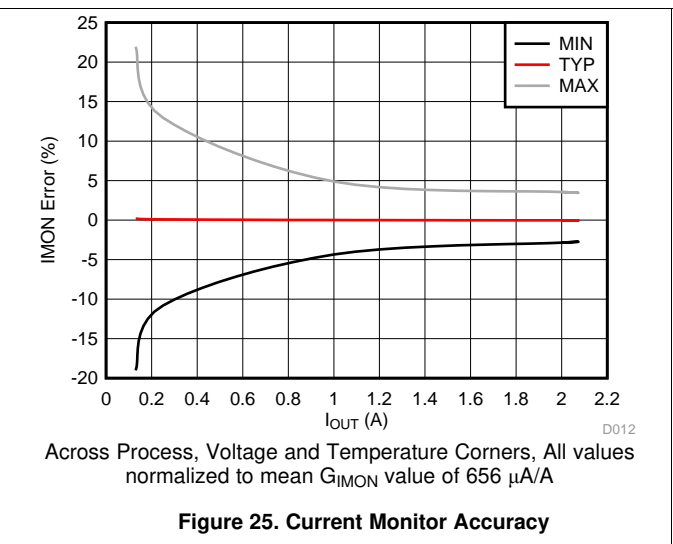
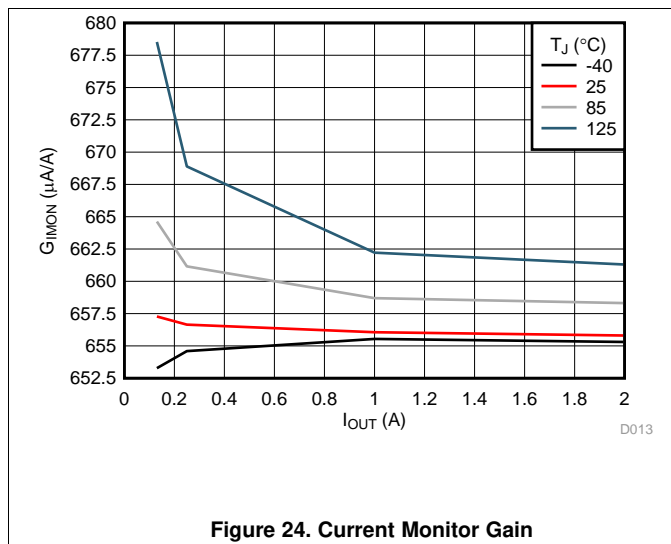
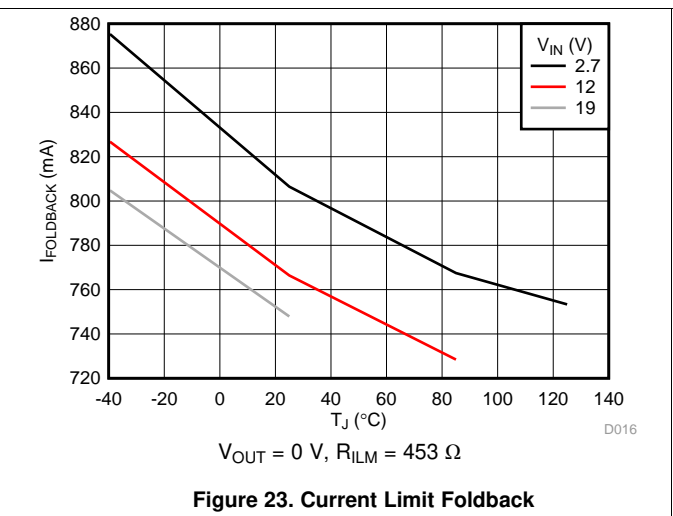
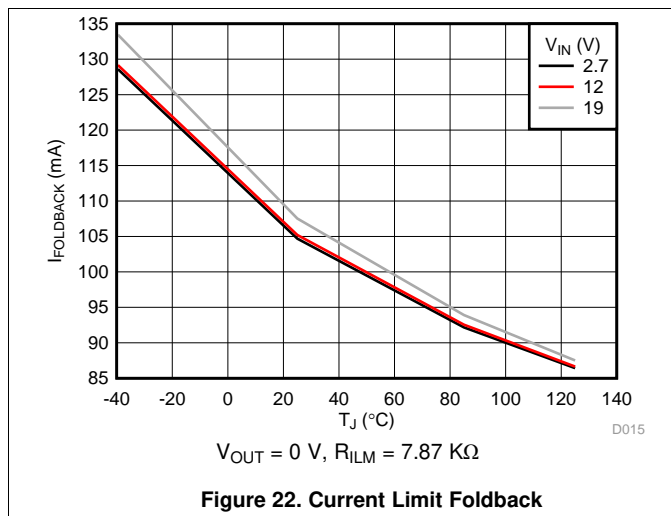
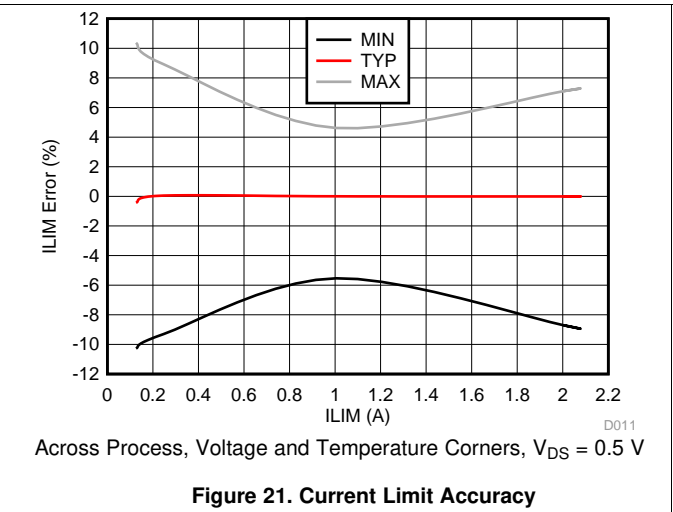
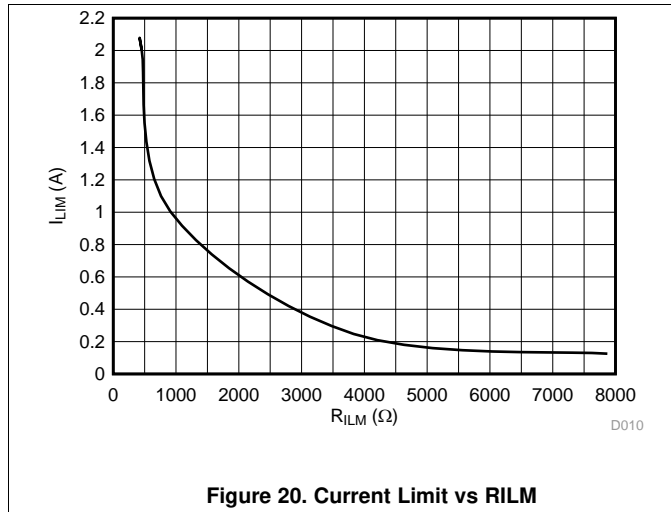

Typical Characteristics (continued)

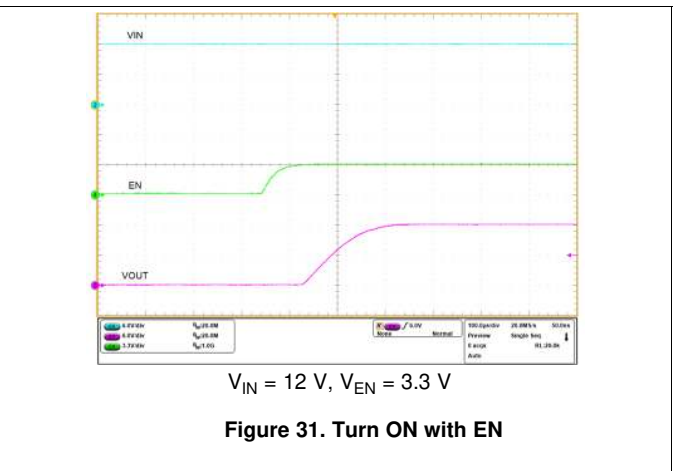
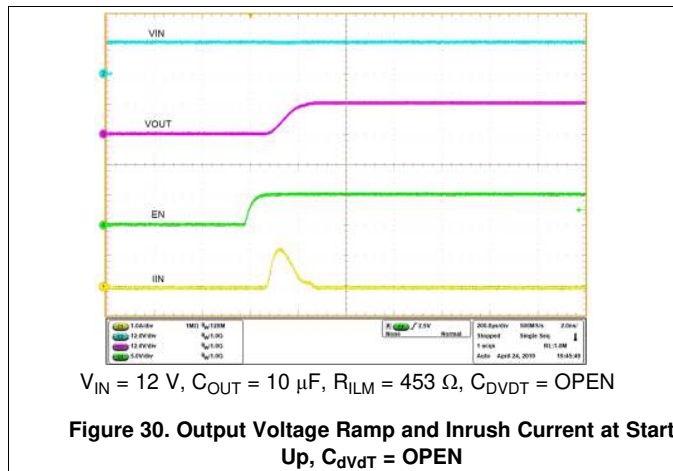
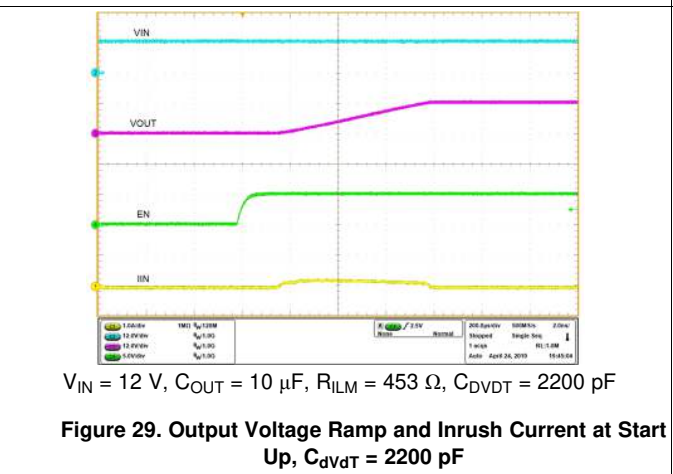
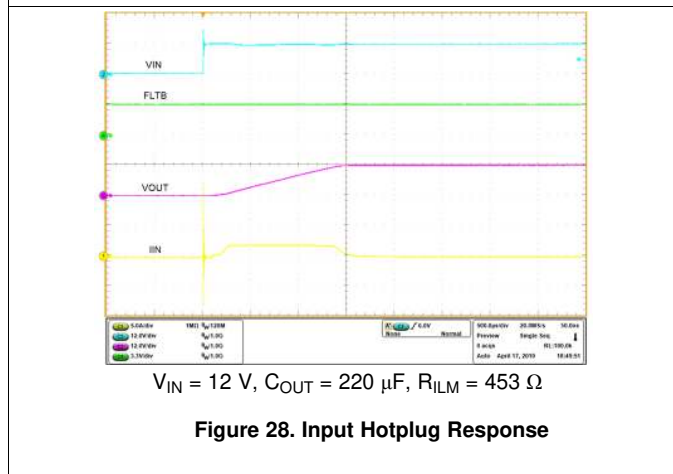
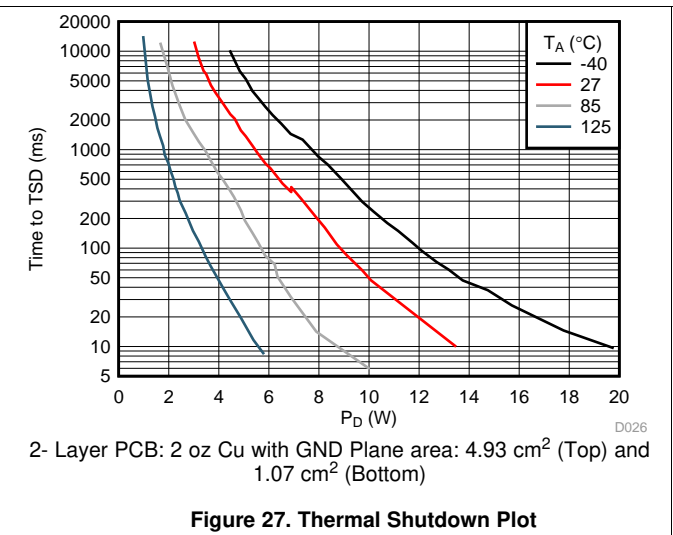
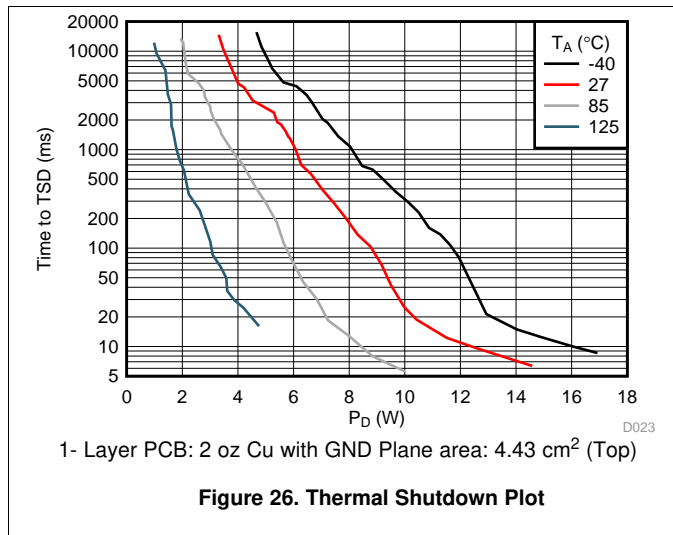

Typical Characteristics (continued)

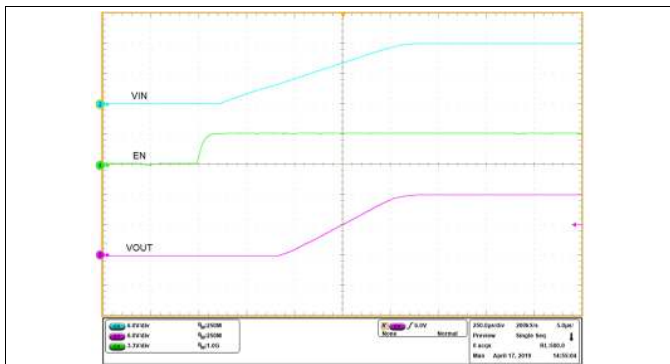

$V_{IN} = 12\text{ V}$ ,  $V_{EN} = 3.3\text{ V}$

Figure 32. Turn ON with VIN

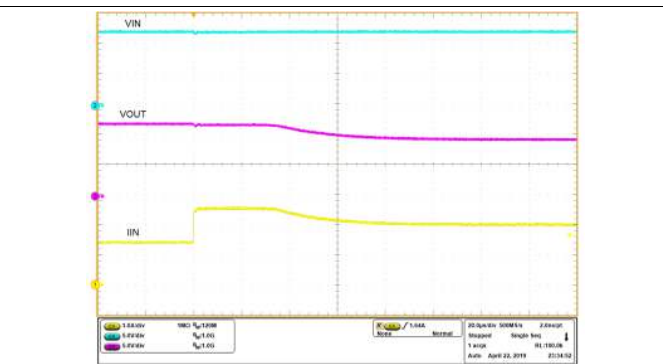

$V_{IN} = 12\text{ V}$ ,  $R_{ILM} = 453\ \Omega$ ,  $R_{OUT}$  Varied From  $8.33\ \Omega$  to  $4.54\ \Omega$

Figure 33. Overcurrent Response

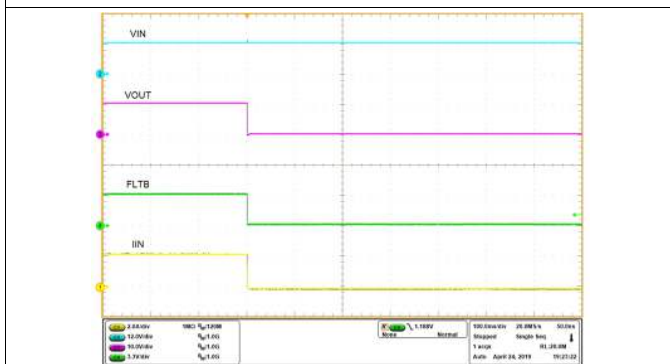

$V_{IN} = 12\text{ V}$ ,  $R_{ILM} = 453\ \Omega$ ,  $R_{OUT} = 5\ \Omega$

Figure 34. Thermal Shutdown Latch-off Response - TPS2596x0

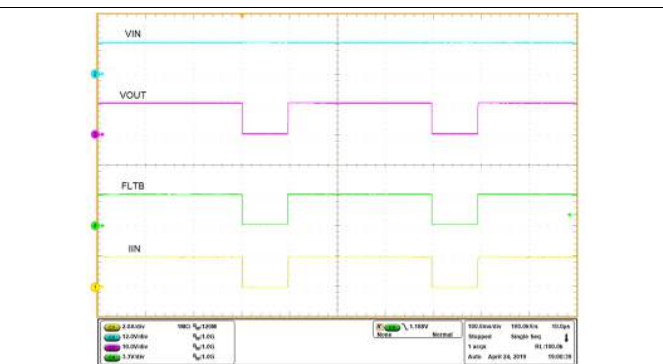

$V_{IN} = 12\text{ V}$ ,  $R_{ILM} = 453\ \Omega$ ,  $R_{OUT} = 5\ \Omega$

Figure 35. Thermal Shutdown Auto-Retry Response - TPS2596x1

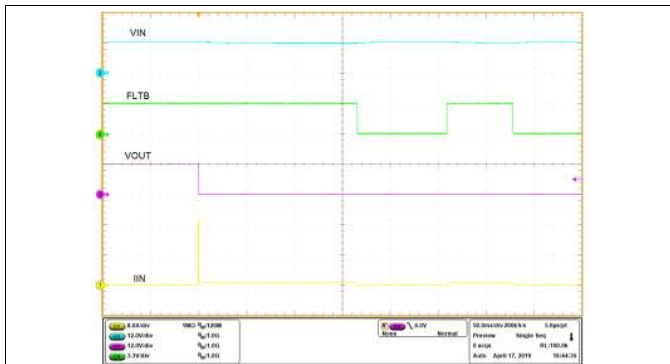

$V_{IN} = 12\text{ V}$ ,  $R_{ILM} = 453\ \Omega$

Figure 36. Short-Circuit While ON Response

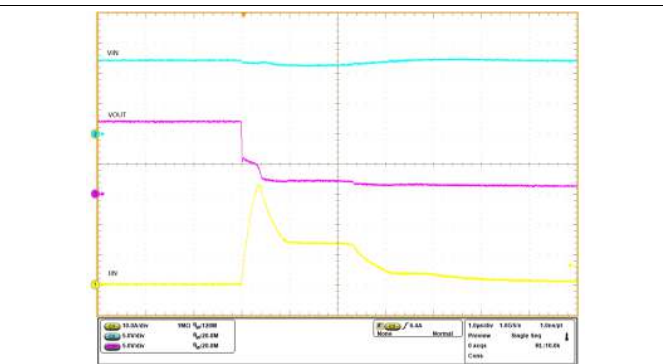

$V_{IN} = 12\text{ V}$ ,  $R_{ILM} = 453\ \Omega$

Figure 37. Short-Circuit While ON Response (Zoomed In)

Typical Characteristics (continued)

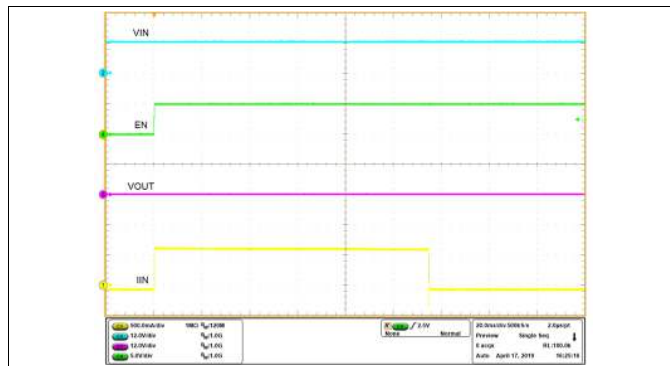

$V_{IN} = 12\text{ V}$ ,  $R_{ILM} = 453\ \Omega$

Figure 38. Power Up Into Short-Circuit

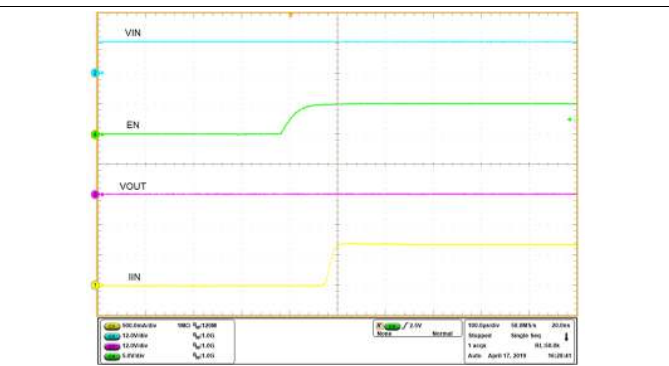

$V_{IN} = 12\text{ V}$ ,  $R_{ILM} = 453\ \Omega$

Figure 39. Power Up Into Short-Circuit (Zoomed In)

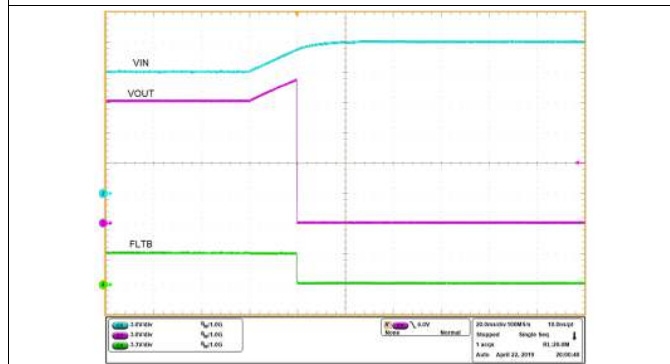

$V_{IN}$  increased from 12 V to 15 V

Figure 40. TPS25963x Overvoltage Lockout Response

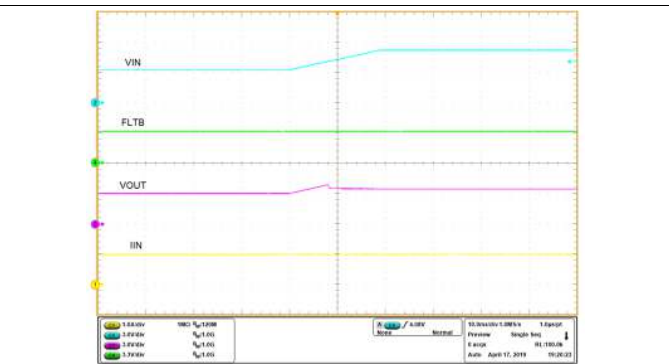

OVCSEL = Shorted to GND,  $V_{IN}$  increased from 3 V to 5 V

Figure 41. TPS25962x Overvoltage Clamp Response

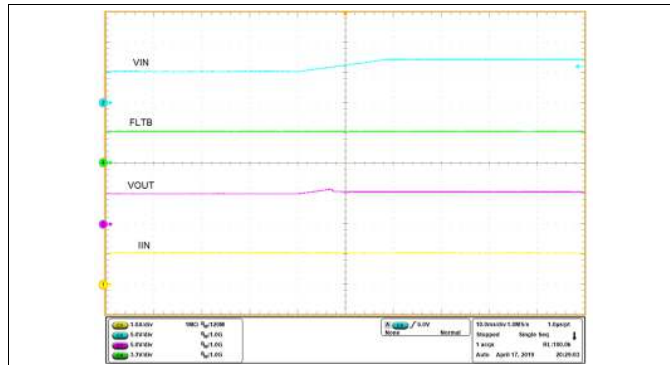

OVCSEL = 400 K $\Omega$  to GND,  $V_{IN}$  increased from 5 V to 7 V

Figure 42. TPS25962x Overvoltage Clamp Response

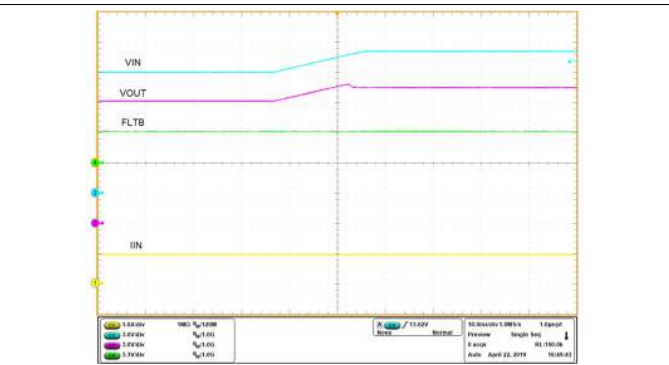

OVCSEL = OPEN,  $V_{IN}$  increased from 12 V to 14 V

Figure 43. TPS25962x Overvoltage Clamp Response





Functional Block Diagram (continued)

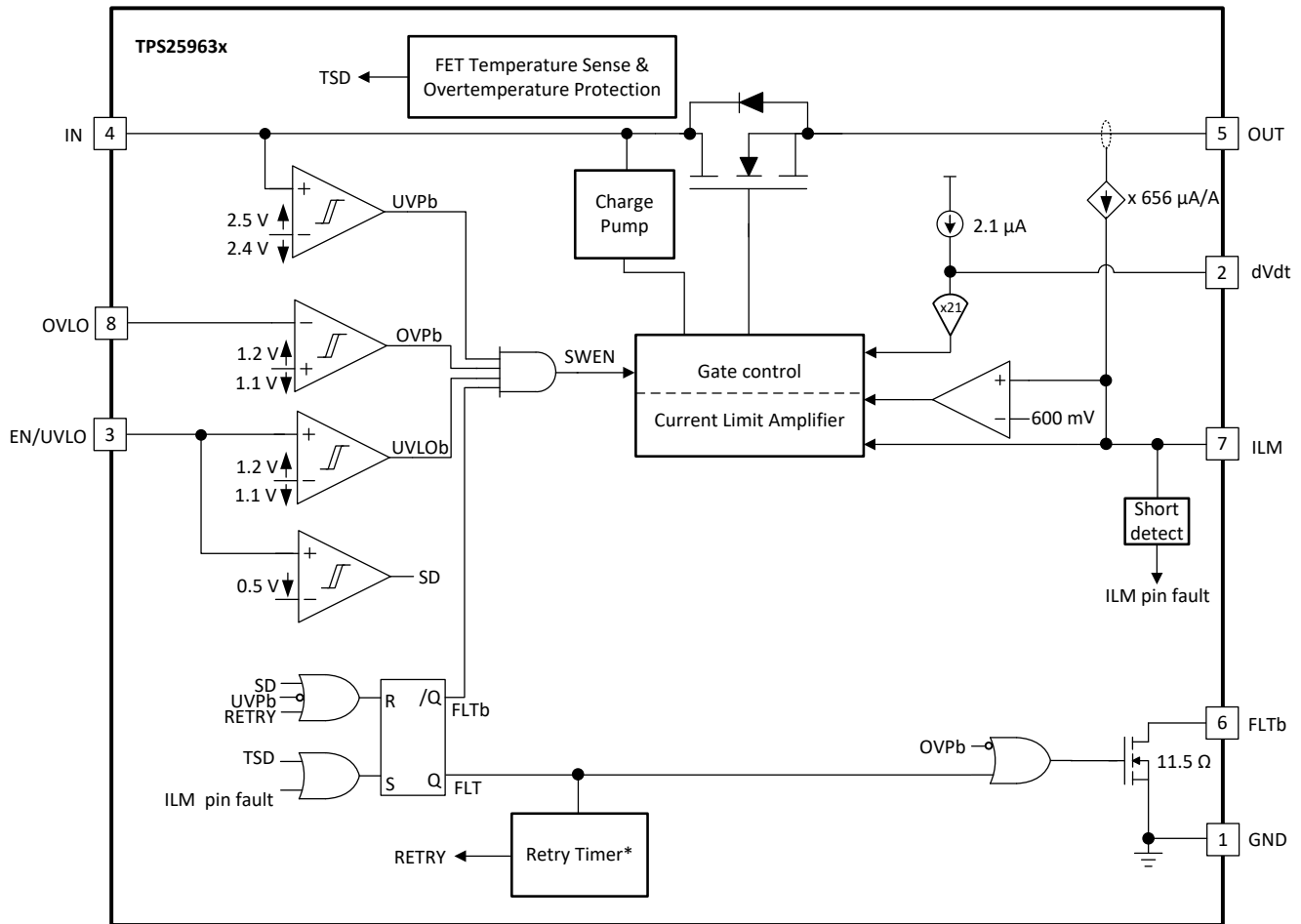

\* Only for Auto-Retry Variant (TPS259631)

8.3 Feature Description

8.3.1 Undervoltage Protection (UVP) and Undervoltage Lockout (UVLO)

TPS2596xx constantly monitors the input supply to ensure that the load is powered up only when the voltage is at a sufficient level. During the start-up condition, the device waits for the input supply to rise above an internal fixed threshold  $V_{UVP(R)}$  before it proceeds to turn ON the FET. Similarly, during the ON condition, if the input supply falls below the UVP threshold  $V_{UVP(F)}$ , the FET is turned OFF. The UVP rising and falling thresholds are slightly different, thereby providing some hysteresis and ensuring stable operation around the threshold voltage.

The TPS2596xx devices also provide an user adjustable UVLO mechanism to ensure that the load is powered up only when the voltage is at a sufficient level. This can be achieved by dividing the input supply and feeding it to the EN/UVLO pin. Whenever the voltage at the EN/UVLO pin falls below a threshold  $V_{UVLO(F)}$ , the device turns OFF the FET. The FET is turned ON again when the voltage rises above the threshold  $V_{UVLO(R)}$ . The rising and falling thresholds on this pin are slightly different, thereby providing some hysteresis and ensuring stable operation around the threshold voltage.

The user must choose the resistor divider values appropriately to map the desired input undervoltage level to the UVLO threshold of the part.

## Feature Description (continued)

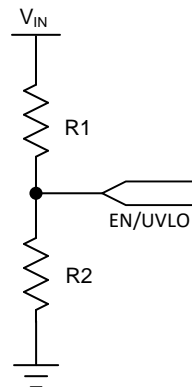

Figure 44. Adjustable Undervoltage Lockout

$$V_{IN(UV)} = V_{UVLO(F)} \times \frac{(R1 + R2)}{R2} \quad (1)$$

### 8.3.2 Overvoltage Protection

The TPS2596xx devices provide 2 ways to handle an input overvoltage condition.

#### 8.3.2.1 Overvoltage Lockout

The TPS25963x variants provide an user adjustable OVLO mechanism to ensure that the supply to the load is cut off if the input supply voltage exceeds a certain level. This can be achieved by dividing the input supply and feeding it to the OVLO pin. Whenever the voltage at the OVLO pin rises above a threshold  $V_{OVLO(R)}$ , the device turns OFF the FET. When the voltage at the OVLO pin falls below the threshold  $V_{OVLO(F)}$ , the FET is turned ON again. The rising and falling thresholds on this pin are slightly different, thereby providing some hysteresis and ensuring stable operation around the threshold voltage.

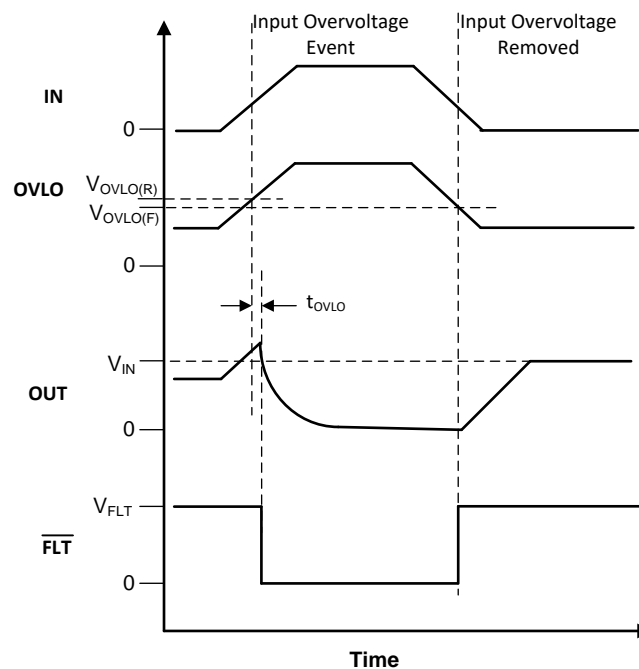
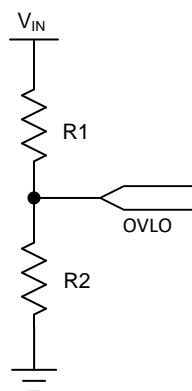

Figure 45. TPS25963x Overvoltage Lockout Response

## Feature Description (continued)

The user should choose the resistor divider values appropriately to map the desired input overvoltage level to the OVLO threshold of the part.



**Figure 46. TPS25963x Adjustable Overvoltage Lockout**

$$V_{IN(OV)} = V_{OVLO(R)} \times \frac{(R_1 + R_2)}{R_2} \quad (2)$$

### 8.3.2.2 Overvoltage Clamp

The TPS25962x variants provide a mechanism to clamp the output voltage to a user-selectable level quickly if the input voltage crosses a certain threshold. This ensures the load is not exposed to high voltages during any input overvoltage events and lowers the dependence on external protection devices (such as TVS/Zener diodes) in this condition. Once the input supply voltage rises above the OVC threshold voltage  $V_{OVC}$ , the device responds by clamping the voltage to  $V_{CLAMP}$  within a very short response time  $t_{OVC}$ . As long as an overvoltage condition is present on the input, the output voltage will be clamped to  $V_{CLAMP}$ . When the input drops below the output clamp threshold  $V_{OVC}$ , the clamp releases the output voltage as shown in [Figure 47](#).

Feature Description (continued)

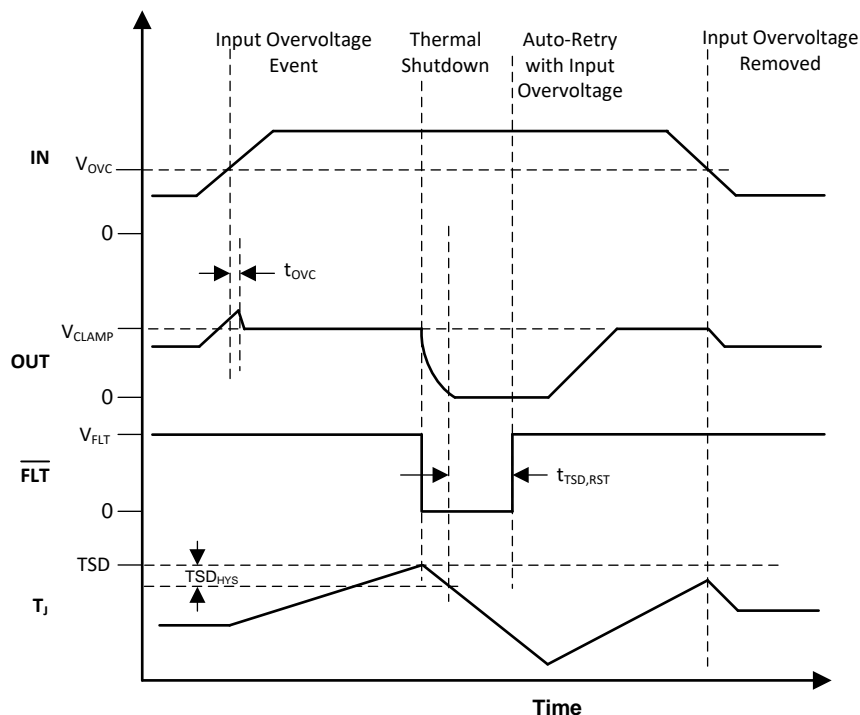

Figure 47. TPS25962x Overvoltage Clamp Response

The OVC threshold can be configured to one of 3 pre-defined levels by connecting the OVCSEL pin as shown in Table 1.

Table 1. TPS25962x Overvoltage Clamp Threshold Selection

OVCSEL Pin Connection	OVC Threshold (typ)
Shorted to GND	3.8 V
Connected to GND through 400 KΩ resistor	5.7 V
Open	13.7 V

During the overvoltage clamp condition, there could be significant heat dissipation in the internal FET depending on the  $V_{IN} - V_{OUT}$  voltage drop and the current ( $I_{OUT}$ ) through the FET leading to thermal shutdown if the condition persists for an extended period of time. In this case, the device would either stay latched-off or start an auto-retry cycle as explained in the *Overtemperature Protection (OTP)* section.

8.3.3 Inrush Current, Overcurrent and Short Circuit Protection

The TPS2596xx devices incorporate three levels of protection against overcurrent:

- Adjustable slew rate for inrush current control (dVdt)
- Active current limiting with adjustable limit ( $I_{LIM}$ ) for overcurrent protection
- Fast short-circuit response to protect against hard short-circuits

8.3.3.1 Slew Rate and Inrush Current Control (dVdt)

The inrush current during turn on is directly proportional to the load capacitance and rising slew rate. Equation 3 can be used to find the slew rate  $SR_{ON}$  required to limit the inrush current  $I_{INRUSH}$  for a given load capacitance  $C_{OUT}$ .

$$SR(mV / \mu s) = \frac{I_{INRUSH}(mA)}{C_L(\mu F)} \quad (3)$$

For loads requiring a slower rising slew rate, a capacitor can be connected to the dVdt pin to adjust the rising slew rate and lower the inrush current during turn on. The required  $C_{dVdt}$  capacitance value to produce a given slew rate can be calculated using [Equation 4](#).

$$C_{dVdt}(pF) = \frac{42000}{SR(mV / \mu s)} \quad (4)$$

### 8.3.3.2 Active Current Limiting

The load current is monitored during start-up and normal operation. When the load current exceeds the current limit  $I_{LIM}$  programmed by  $R_{ILM}$  resistor, the device regulates the current to the set limit  $I_{LIM}$  within  $t_{LIM}$ . The device exits current limiting when the load current falls below  $I_{LIM}$ . [Equation 5](#) can be used to find the  $R_{ILM}$  value for a desired current limit.

$$R_{ILM}(\Omega) = \frac{903}{I_{LIM}(A) - 0.0112} \quad (5)$$

In the current limiting state, the output voltage drops resulting in increased power dissipation in the internal FET leading to thermal shutdown if the condition persists for an extended period of time. In this case, the device either stays latched-off or starts an auto-retry cycle as explained in the [Overtemperature Protection \(OTP\)](#) section.

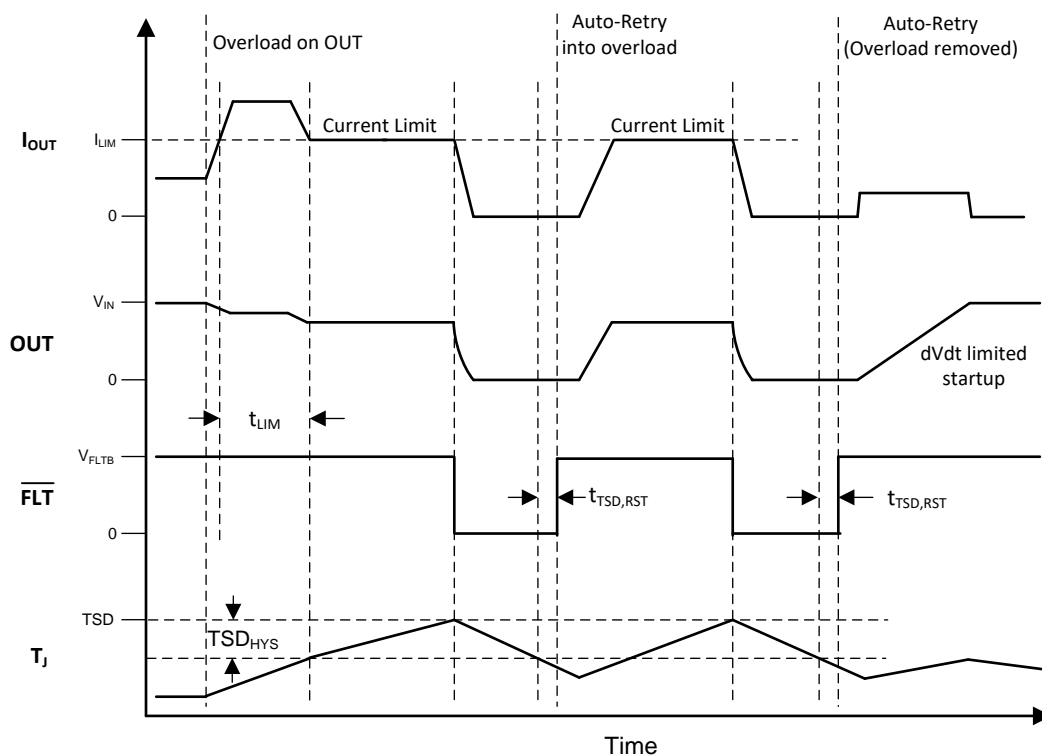

**Figure 48. TPS2596x1 Overcurrent Response (Auto-retry)**

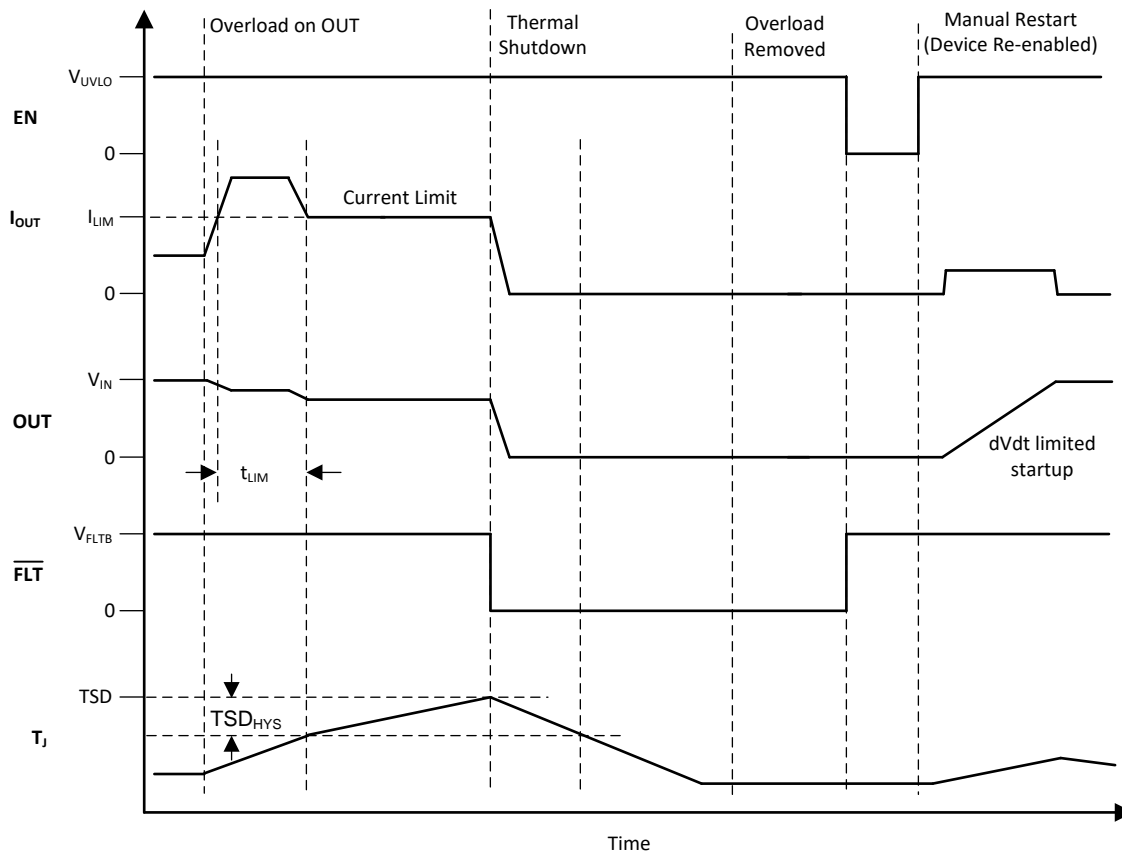

Figure 49. TPS2596x0 Overcurrent Response (Latch-off)

### 8.3.3.3 Short-Circuit Protection

The current through the device increases very rapidly during a short-circuit event. If the current exceeds  $1.5 \times I_{LIM}$ , the device engages a fast current clamping circuit to regulate down the current faster than the nominal overcurrent response time ( $t_{LIM}$ ). The device does not completely turn off the power FET to ensure uninterrupted power in the event of transient overcurrents or supply transients. The device stops limiting the current once the load current falls below the programmed  $I_{LIM}$  threshold.

The output voltage drops in the current limiting state, resulting in increased power dissipation in the internal FET and might lead to thermal shutdown if the condition persists for an extended period of time. In this case, the device either stays latched-off or starts an auto retry cycle as explained in the [Overtemperature Protection \(OTP\)](#) section.

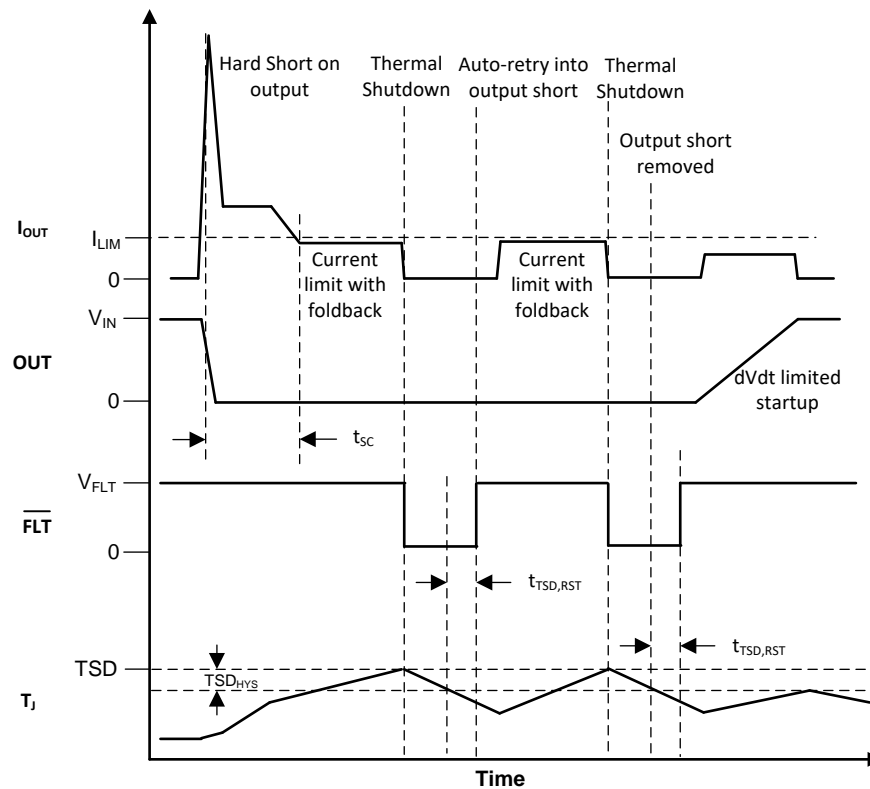

Figure 50. TPS2596xx Short Circuit Response

### 8.3.4 Analog Load Current Monitor (IMON)

The device allows the system to monitor the output load current accurately by providing an analog current on the ILM pin which is proportional to the current ( $I_{OUT}$ ) through the FET. The user can sense the voltage ( $V_{ILM}$ ) across the  $R_{ILM}$  to get a measure of the output load current.

$$I_{OUT}(A) = \frac{V_{ILM}(V)}{G_{IMON}(\mu A / A) \times R_{ILM}(\Omega)} \tag{6}$$

### 8.3.5 Overtemperature Protection (OTP)

Thermal Shutdown will occur when the junction temperature ( $T_J$ ) exceeds the thermal shutdown threshold (TSD). When the TPS2596x0 variant detects thermal overload, it will be shut down and remain latched off until the device is power cycled or re-enabled by toggling the EN/UVLO pin. When the TPS2596x1 variant detects thermal overload, it will remain off until it has cooled down sufficiently. Once the TPS2596x1 junction has cooled down below  $TSD - TSD_{HYS}$ , it will remain off for an additional delay of  $t_{TSD,RST}$  after which it will automatically retry to turn on if it is still enabled.

Table 2. TPS2596x Thermal Shutdown

Device	Enter TSD	Exit TSD
TPS2596x0 (Latch-Off)	$T_J \geq TSD$	$T_J < TSD - TSD_{HYS}$ and Power Cycle ( $V_{IN} < V_{UVP(F)}$ ) / Enable Cycle ( $V_{EN} < V_{SD}$ )
TPS2596x1 (Auto-Retry)	$T_J \geq TSD$	$T_J < TSD - TSD_{HYS}$ and $t_{TSD,RST}$ timer expired



### 8.3.6 Fault Indication

Table 3 summarizes the protection response to various fault conditions.

**Table 3. Fault Response**

Event / Fault	Protection Response	$\overline{\text{FLT}}$ Asserted	$\overline{\text{FLT}}$ Delay
Overtemperature	Shutdown	Yes	
Undervoltage	Cut-off	No	
Overvoltage	Clamp (OVC - TPS25962x only)	No	
	Cut-off (OVLO - TPS25963x only)	Yes	$t_{\text{ovLo}}$
Overcurrent	Current Limit	No	
Short-Circuit	Current Limit	No	
ILM Pin Short to GND	Shut down	Yes	
ILM Pin Open	Shut down	No	

When the device turns off due to one of these fault conditions, the  $\overline{\text{FLT}}$  pin is pulled low.

Power cycling the part or pulling the EN/UVLO pin voltage below  $V_{\text{SD}}$  clears the fault and the  $\overline{\text{FLT}}$  pin is de-asserted. It also clears the  $t_{\text{TSD,RST}}$  timer (Auto-retry variants only). Pulling the EN/UVLO just below the UVLO threshold ( $V_{\text{UVLO(F)}}$ ) has no impact on the device in this condition. This is true for both Latch-off (TPS2596x0) and Auto-retry (TPS2596x1) variants.

For Auto-retry (TPS2596x1) variants, at the end of the  $t_{\text{TSD,RST}}$  timer after a fault, the device restarts automatically and the  $\overline{\text{FLT}}$  pin is de-asserted.

## 8.4 Device Functional Modes

The features of the device depend on the operating mode.

### 8.4.1 Enable and Fault Pin Functional Mode 1: Single Device, Self-Controlled

In this mode of operation, the device is enabled by the VIN voltage without the need of an external processor to drive the ENABLE pin. The  $\overline{\text{FLT}}$  pin is optionally monitored by an external host as shown in Figure 51.

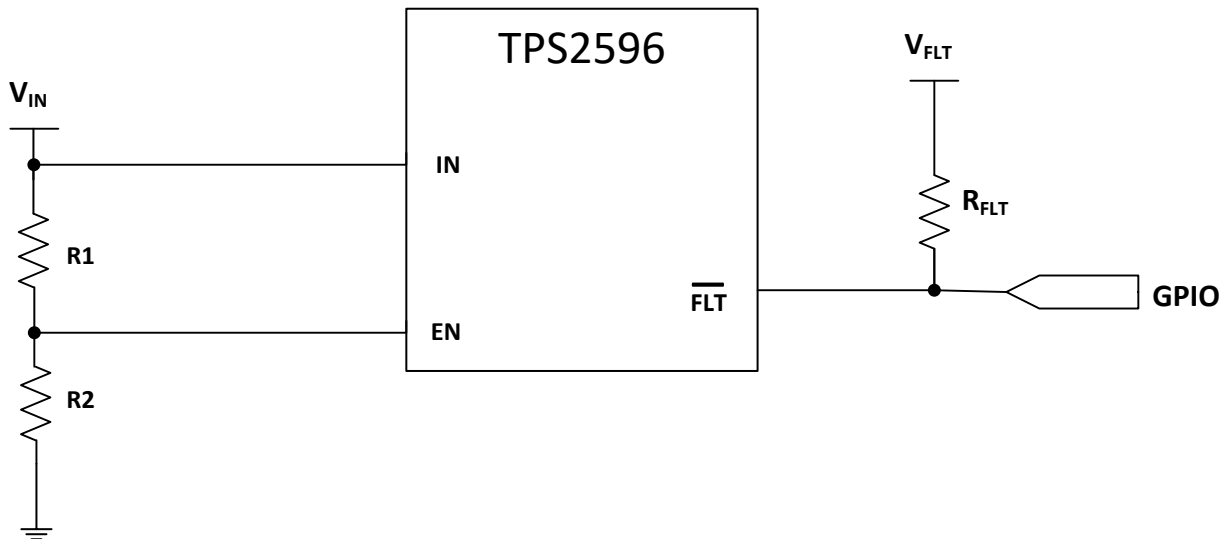

**Figure 51. Single Device, Self-Controlled**

### 8.4.2 Enable and Fault Pin Functional Mode 2: Single Device, Host-Controlled

In this mode of operation, the device is enabled by the VIN voltage without the need of an external processor to drive the ENABLE pin. The  $\overline{\text{FLT}}$  pin is optionally monitored by an external host as shown in Figure 53.

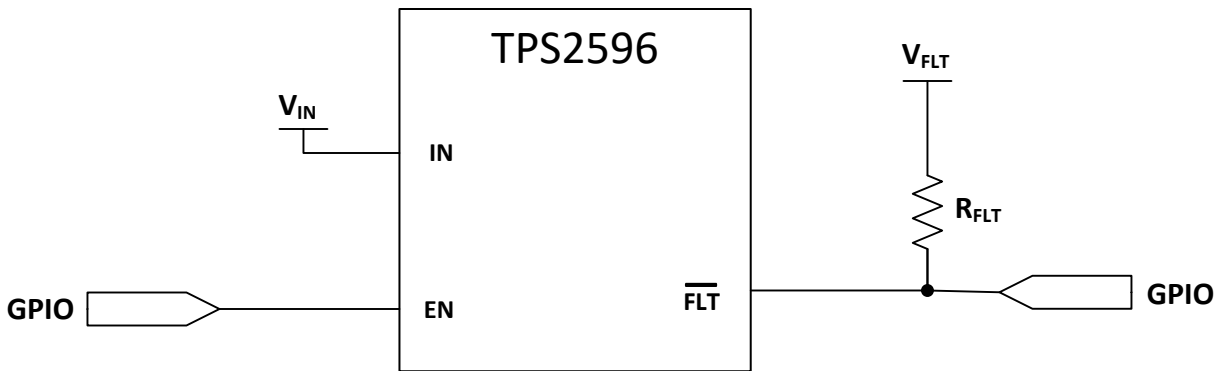
**Device Functional Modes (continued)**

**Figure 52. Single Device, Self-Controlled**
**8.4.3 Enable and Fault Pin Functional Mode 3: Multiple Devices, Self-Controlled**

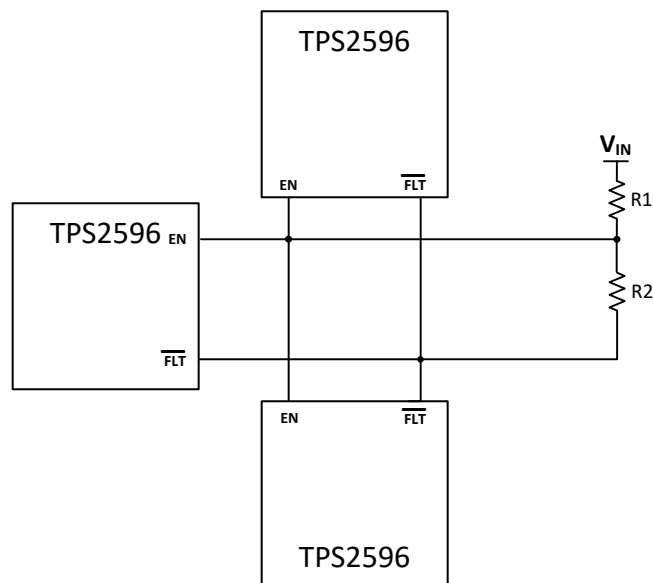
In this mode of operation, the devices are self-controlled (no host present). The EN and  $\overline{\text{FLT}}$  pins of multiple devices are shorted together as shown in Figure 52. In this configuration, when any one of the TPS2596xx devices detects a fault, it automatically disables the other TPS2596xx devices in the system.

**Figure 53. Multiple Devices, Self-Controlled**

## 9 Application and Implementation

### NOTE

Information in the following applications sections is not part of the TI component specification, and TI does not warrant its accuracy or completeness. TI's customers are responsible for determining suitability of components for their purposes. Customers should validate and test their design implementation to confirm system functionality.

### 9.1 Application Information

The TPS2596xx device is an integrated eFuse that is typically used for hot-swap and power rail protection applications. The device operates from 2.7 V to 19 V with adjustable current limit and undervoltage protection. The device aids in controlling the in-rush current and provides precise current limiting during overload conditions for systems such as energy meters, white goods, building automation and adapter input protection. The device also provides robust protection for multiple faults on the sub-system rail.

The following design procedure can be used to select the supporting component values based on the application requirement.

### 9.2 Typical Application

#### 9.2.1 Precision Current Limiting and Protection for White Goods

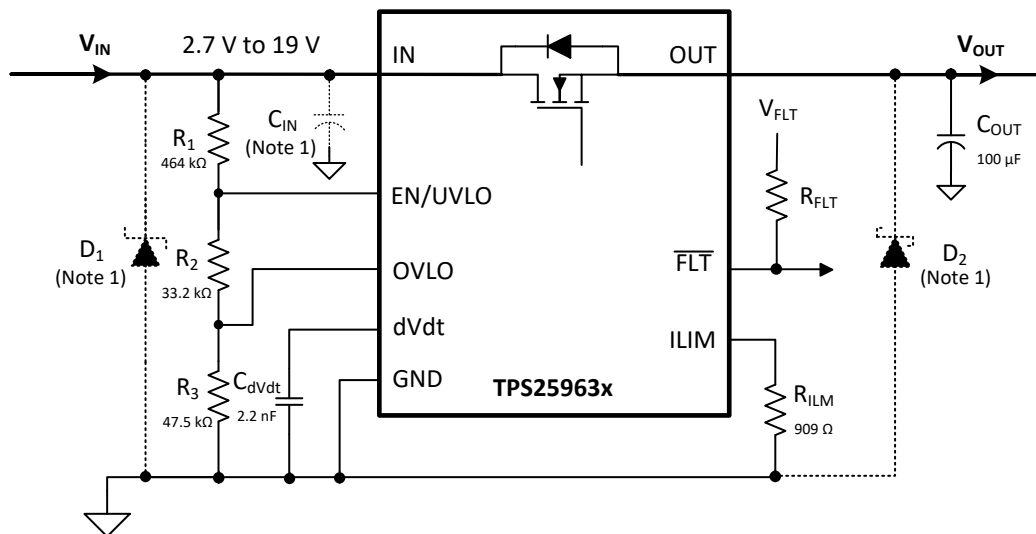

- (1)  $C_{IN}$  is optional and 0.1  $\mu\text{F}$  is recommended to suppress transients due to the inductance of PCB routing or from input wiring. If system needs to pass IEC 61000-4-4 EFT test, minimum  $C_{IN}$  of 1  $\mu\text{F}$  should be used to prevent eFuse from turning off during EFT bursts.

Figure 54. Typical Application Schematic: Simple eFuse for White Goods

#### 9.2.2 Design Requirements

Table 4. Design Parameters

DESIGN PARAMETER	EXAMPLE VALUE
Input voltage, $V_{IN}$	12 V
Undervoltage lockout set point, $V_{UV}$	8 V
Overvoltage protection set point, $V_{OV}$	13.7 V
Overvoltage protection type	Lock-out
Load at start-up, $R_{L(SU)}$	24 $\Omega$

## Typical Application (continued)

**Table 4. Design Parameters (continued)**

DESIGN PARAMETER	EXAMPLE VALUE
Current limit, $I_{LIM}$	1 A
Load capacitance, $C_{OUT}$	100 $\mu$ F
Maximum ambient temperatures, $T_A$	85°C

### 9.2.3 Detailed Design Procedure

The designer must know the following:

- Normal input operation voltage
- Maximum output capacitance
- Maximum current limit
- Load during start-up
- Maximum ambient temperature of operation

This design procedure seeks to control the junction temperature of device under both static and transient conditions by proper selection of output ramp-up time and associated support components. The designer can adjust this procedure to fit the application and design criteria. A spreadsheet design tool [TPS2596 Design Calculator](#) is also available for simplified calculations.

#### 9.2.3.1 Programming the Current-Limit Threshold: $R_{ILM}$ Selection

The  $R_{ILM}$  resistor at the ILM pin sets the over load current limit, this can be set using [Equation 7](#).

$$R_{ILM}(\Omega) = \frac{903}{I_{LIM}(A) - 0.0112} = \frac{903}{1 - 0.0112} = 913.2 \Omega \quad (7)$$

Choose closest standard value resistor: 909  $\Omega$  with 1% tolerance.

#### 9.2.3.2 Undervoltage and Overvoltage Lockout Set Point

The undervoltage lockout (UVLO) and overvoltage lockout (OVLO) trip point is adjusted using the external voltage divider network of  $R_1$ ,  $R_2$  and  $R_3$  as connected between IN, EN/UVLO, OVLO and GND pins of the device. The values required for setting the undervoltage and overvoltage are calculated solving [Equation 8](#) and [Equation 9](#).

$$V_{UVLO} = \frac{R_2 + R_3}{(R_1 + R_2 + R_3)} \times V_{IN(UV)} \quad (8)$$

$$V_{OVLO} = \frac{R_3}{(R_1 + R_2 + R_3)} \times V_{IN(OV)} \quad (9)$$

Where  $V_{UVLO(R)}$  is UVLO rising threshold (1.2 V). Because  $R_1$ ,  $R_2$  and  $R_3$  leak the current from input supply  $V_{IN}$ , these resistors must be selected based on the acceptable leakage current from input power supply  $V_{IN}$ .

The current drawn by  $R_1$ ,  $R_2$  and  $R_3$  from the power supply is  $I_{R123} = V_{IN} / (R_1 + R_2 + R_3)$ .

However, leakage currents due to external active components connected to the resistor string can add error to these calculations. So, the resistor string current,  $I_{R123}$  must be chosen to be 20 times greater than the leakage current expected.

From the device electrical specifications,  $V_{OVLO} = 1.2$  V and  $V_{UVLO} = 1.2$  V. For design requirements,  $V_{OV} = 13.7$  V and  $V_{UV} = 8$  V. To solve the equation, first choose the value of  $R_3 = 47$  k $\Omega$  and use [Equation 9](#) to solve for  $(R_1 + R_2) = 489.58$  k $\Omega$ . Use [Equation 8](#) and value of  $(R_1 + R_2)$  to solve for  $R_2 = 33.48$  k $\Omega$  and finally  $R_1 = 456.1$  k $\Omega$ . Using the closest standard 1% resistor values gives  $R_1 = 464$  k $\Omega$ ,  $R_2 = 33.2$  k $\Omega$ , and  $R_3 = 47.5$  k $\Omega$ .

### 9.2.3.3 Setting Output Voltage Ramp Time ( $T_{dVdT}$ )

For a successful design, the junction temperature of device must be kept below the absolute maximum rating during both dynamic (start-up) and steady state conditions. Dynamic power stresses often are an order of magnitude greater than the static stresses, so it is important to determine the right start-up time and in-rush current limit required with system capacitance to avoid thermal shutdown during start-up with and without load.

The required ramp-up capacitor  $C_{dVdT}$  is calculated considering the two possible cases (see [Case 1: Start-Up Without Load. Only Output Capacitance  \$C\_{OUT}\$  Draws Current](#) and [Case 2: Start-Up With Load. Output Capacitance  \$C\_{OUT}\$  and Load Draw Current](#)).

#### 9.2.3.3.1 Case 1: Start-Up Without Load. Only Output Capacitance $C_{OUT}$ Draws Current

During start-up, as the output capacitor charges, the voltage drop as well as the power dissipated across the internal FET decreases. The average power dissipated in the device during start-up is calculated using [Equation 11](#).

For TPS2596xx device, the inrush current is determined as shown in [Equation 10](#).

$$I_{INRUSH} = C_{OUT} \times \frac{V_{IN}}{T_{dVdT}} \quad (10)$$

Power dissipation during start-up is shown in [Equation 11](#).

$$P_{D(INRUSH)} = 0.5 \times V_{IN} \times I_{INRUSH} \quad (11)$$

[Equation 11](#) assumes that load does not draw any current until the output voltage has reached its final value.

#### 9.2.3.3.2 Case 2: Start-Up With Load. Output Capacitance $C_{OUT}$ and Load Draw Current

When the load draws current during the turnon sequence, there is additional power dissipated. Considering a resistive load during start-up  $R_{L(SU)}$ , load current ramps up proportionally with increase in output voltage during  $T_{dVdT}$  time. Equations 12 to 15 show the average power dissipation in the internal FET during charging time due to resistive load.

$$P_{D(LOAD)} = \left(\frac{1}{6}\right) \times \frac{V_{IN}^2}{R_{L(SU)}} \quad (12)$$

Total power dissipated in the device during start-up is [Equation 13](#).

$$P_{D(STARTUP)} = P_{D(INRUSH)} + P_{D(LOAD)} \quad (13)$$

Total current during start-up is given by [Equation 14](#).

$$I_{STARTUP} = I_{INRUSH} + I_L(t) \quad (14)$$

If  $I_{STARTUP} > I_{LIMIT}$ , the device limits the current to  $I_{LIMIT}$  and the current-limited charging time is determined by [Equation 15](#).

$$T_{dVdT(\text{Current-Limited})} = C_{OUT} \times R_{L(SU)} \times \left[ \frac{I_{LIMIT}}{I_{INRUSH}} - 1 + \text{LN} \left( \frac{I_{INRUSH}}{I_{LIMIT} - \frac{V_{IN}}{R_{L(SU)}}} \right) \right] \quad (15)$$

The power dissipation, with and without load, for selected start-up time must not exceed the shutdown limits as shown in [Figure 55](#).

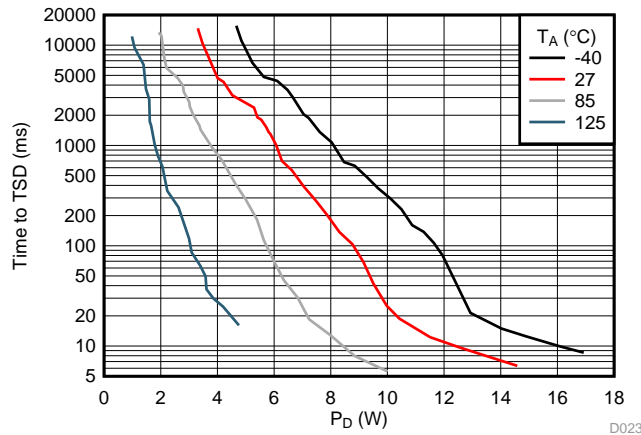

**Figure 55. Thermal Shutdown Limit Plot**

For the design example under discussion, select ramp-up capacitor  $C_{dVdt} = 22000$  pF. The default slew rate for  $C_{dVdt} = 22000$  pF is  $1.9$  mV/ $\mu$ s. With slew rate of  $1.9$  mV/ $\mu$ s, the ramp-up time  $T_{dVdt}$  for  $12$  V input is  $6.3$  ms.

The inrush current drawn by the load capacitance  $C_{OUT}$  during ramp-up using Equation 16.

$$I_{INRUSH} = \frac{100 \mu\text{F} \times 1.9 \text{ mV}}{\mu\text{s}} = 190 \text{ mA} \tag{16}$$

The inrush power dissipation is calculated using Equation 17.

$$P_{D(INRUSH)} = 0.5 \times 12 \times 190 \text{ m} = 1.14 \text{ W} \tag{17}$$

For  $1.14$  W of power loss, the thermal shutdown time of the device must not be less than the ramp-up time  $T_{dVdt}$  to avoid the false trip at the maximum operating temperature. Figure 55 shows the thermal shutdown limit at  $T_A = 85$  °C, for  $1.14$  W of power, the shutdown time is infinite. Therefore, it is safe to use  $6.3$  ms as the start-up time without any load on the output.

The additional power dissipation when a  $10\text{-}\Omega$  load is present during start-up is calculated using Equation 18.

$$P_{D(LOAD)} = \left(\frac{1}{6}\right) \times \frac{12 \times 12}{24} = 1\text{W} \tag{18}$$

The total device power dissipation during start-up is given in Equation 19.

$$P_{D(STARTUP)} = 1 + 1.14 = 2.24 \text{ W} \tag{19}$$

Figure 55 shows  $T_A = 85$  °C and the thermal shutdown time for  $2.24$  W is approximately  $2000$  ms, which increases the margins further for shutdown time and ensures successful operation during start up and steady state conditions.

When  $C_{OUT}$  is large, there is a need to decrease the power dissipation during start-up. This can be done by increasing the value of the  $C_{dVdt}$  capacitor.

### 9.2.4 Support Component Selection: $R_{FLT}$ and $C_{IN}$

Referring to application schematics,  $R_{FLT}$  is required only if  $\overline{FLT}$  is used; The resistor serves as pull-up for the open-drain output driver. The current sunk by this pin should not exceed  $10$  mA.  $C_{IN}$  is a bypass capacitor to help control transient voltages, unit emissions, and local supply noise. Where acceptable, a value in the range from  $0.001$   $\mu$ F to  $0.1$   $\mu$ F is recommended for  $C_{IN}$ .

### 9.2.5 Application Curves

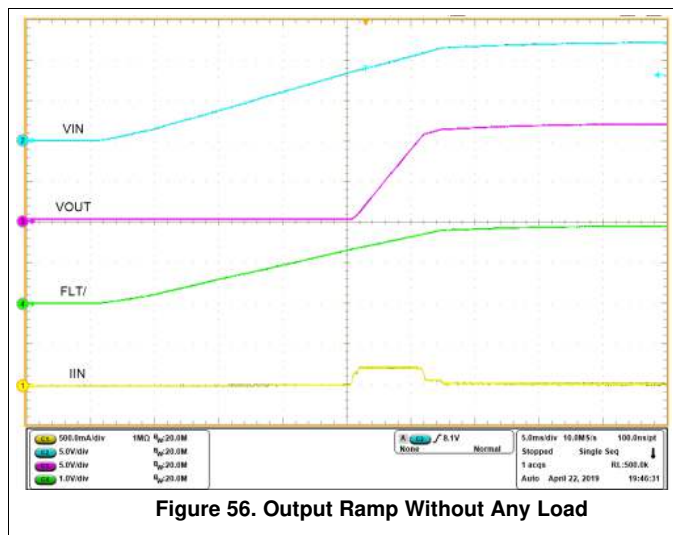

Figure 56. Output Ramp Without Any Load

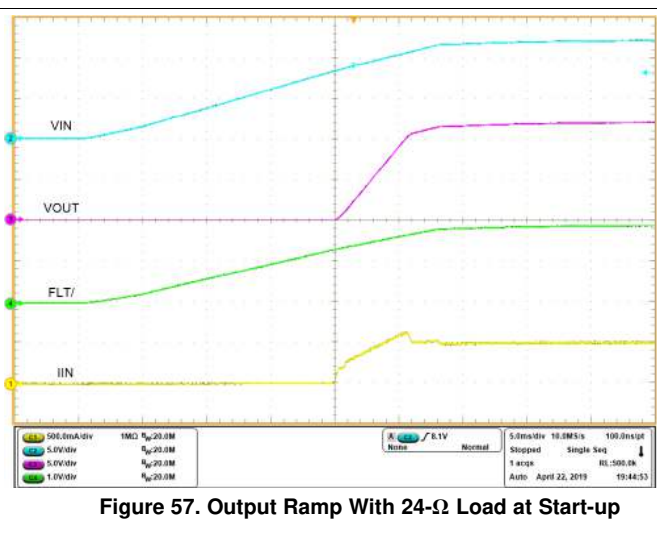

Figure 57. Output Ramp With 24-Ω Load at Start-up

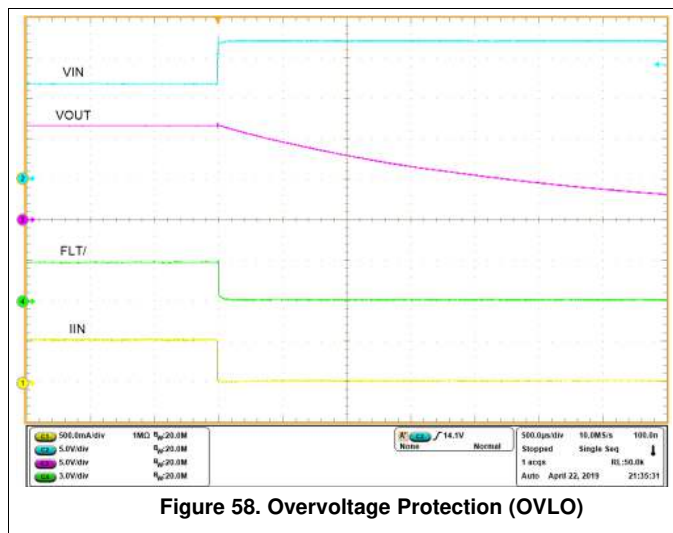

Figure 58. Overvoltage Protection (OVLO)

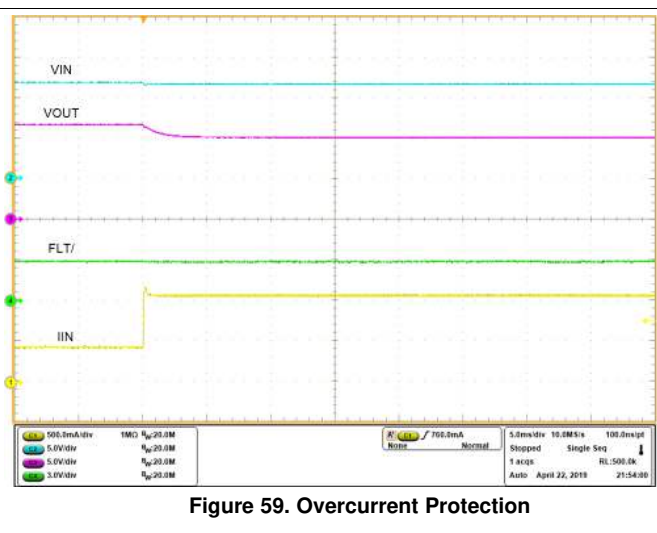

Figure 59. Overcurrent Protection

## 9.3 System Examples

The TPS2596xx provides a simple solution for current limiting, inrush current control and supervision of power rails for wide range of applications operating at 2.7 V to 19 V and delivering up to 2 A.

### 9.3.1 Current Limiting and Overvoltage Protection and for Energy Meter Power Rails

Energy meters generally use a single AC/DC power supply (for example: flyback converter) with multiple DC outputs for powering blocks like Metrology (analog front-end, microcontroller, memory), Real Time Clock (RTC), Relay (for remote load connect/disconnect) and Communications module. Metrology is the most critical sub-system and is required to operate uninterrupted under all conditions, even if a fault occurs in any of the supplementary blocks. One solution would be to oversize the power supply design so that it can handle the excess current demands during a fault condition, which increases the cost of the meter. A more elegant and cost-optimized solution would be to add an eFuse like TPS2596xx on the supplementary power rails, which provides accurate current limiting and fast short-circuit protection, thereby ensuring reliable operation of the metrology block without increasing the size or cost of the power supply. Apart from that, the TPS2596xx provides additional benefits such as:

- Overvoltage Protection (Lock-out and Clamp) to shield down-stream low voltage circuits from harmful overvoltages arising from poor cross-regulation between windings or AC input voltage surges.

## System Examples (continued)

- Disconnect supply to rarely used loads to minimize power consumption

Figure 60 shows a typical energy meter power supply implementation using TPS2596xx.

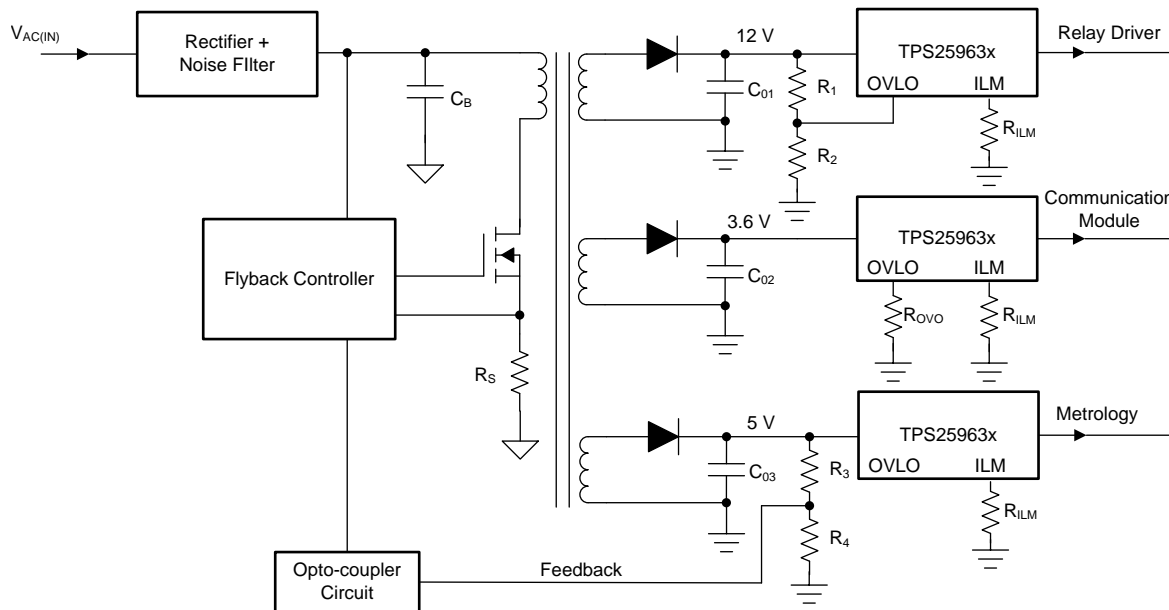

**Figure 60. Energy Meter Power Rail Protection Example**

TIDA-010037 demonstrates energy meter design using eFuse for protecting auxiliary rails.

### 9.3.2 Precision Current Limiting and Protection in Appliances

Household and similar electrical appliances are subjected to various tests (for example: needle flame, glow wire) as part of the certification for electrical and fire safety compliance as per the regulations. Special precautions need to be taken in the design to pass these tests, which include the use of higher grade flame retardant plastic material for the housing enclosures. There are certain provisions in the standard which can be leveraged to make the certification easier, faster and also reduce the cost of plastic materials. For example, any node which has less than 15 W of power available to it is classified as a LPC (Low Power Circuit as per the definition in IEC 60335-1) and deemed to be safe. All circuits or sub-systems further downstream from a LPC node are exempt from the aforementioned tests.

eFuses like TPS2596xx are a simple and cost effective way to limit the power delivered to the downstream load. The key parameter to be considered is the current limit tolerance and accuracy, which determines how high one can set the nominal current limit without exceeding the 15-W power limit on the upper end. On the lower end, it determines the maximum power the load can draw in normal conditions without hitting the current limit. TPS2596xx provides a current limit accuracy of  $\pm 5\%$  (at room temperature), which allows the load to use nearly 90% out of the 15-W limit under normal operating conditions.

In contrast, an alternative current limiting solution with wider current limit tolerance, say  $\pm 25\%$  would leave only 50% out of 15 W for the load circuit to operate under normal conditions. This places severe constraints on the load circuit design and/or capabilities.

Figure 61 shows a sub-system example of a refrigerator and freezer system where TPS2596xx is used for precision current limiting and protection of 15-W rails to ease the qualification as low-power circuit as per IEC 60335-1.



System Examples (continued)

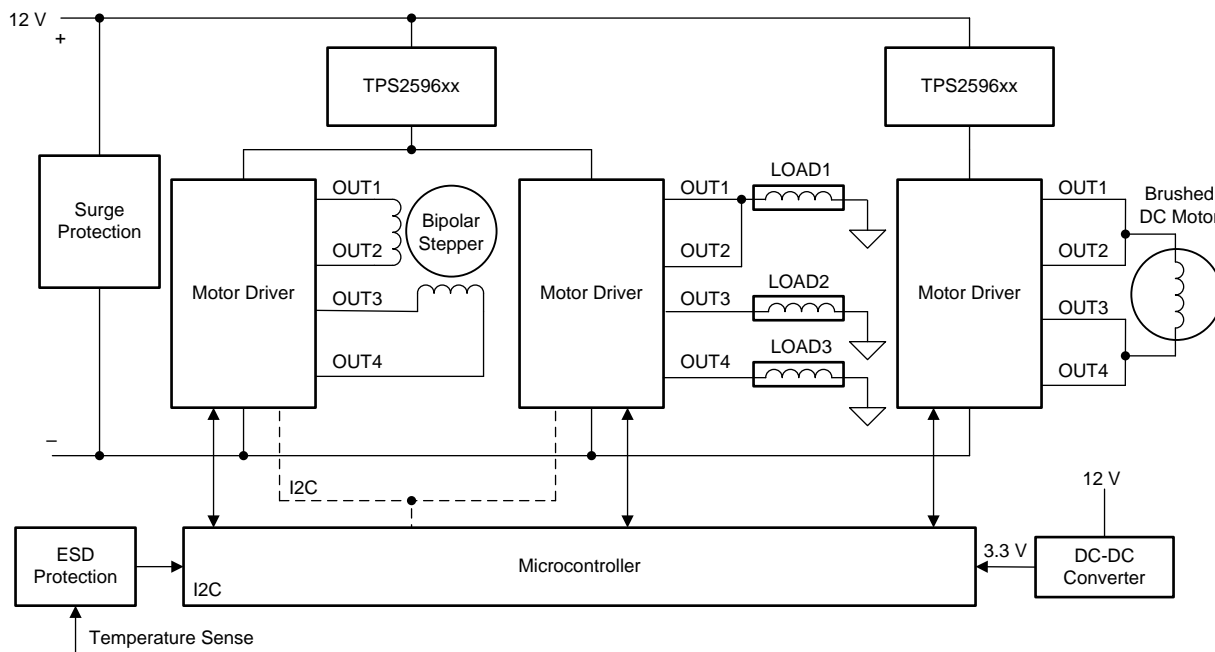

Figure 61. Appliances 15-W LPC Implementation Example

TIDA-010004 demonstrates a multi-load drive using single driver chip with eFuse for protection and 15-W LPC implementation.

Refer to this [Designing Low-Power Circuits \(LPCs\) using TPS2596 for Household and similar Appliances](#) application note for a detailed insight into implementing power limited circuits using eFuses.

## 10 Power Supply Recommendations

The TPS2596xx devices are designed for a supply voltage range of  $2.7\text{ V} \leq V_{IN} \leq 19\text{ V}$ . An input ceramic bypass capacitor higher than  $0.1\text{ }\mu\text{F}$  is recommended if the input supply is located more than a few inches from the device. The power supply must be rated higher than the set current limit to avoid voltage droops during overcurrent and short-circuit conditions.

### 10.1 Transient Protection

In the case of a short circuit and overload current limit when the device interrupts current flow, the input inductance generates a positive voltage spike on the input, and the output inductance generates a negative voltage spike on the output. The peak amplitude of voltage spikes (transients) is dependent on the value of inductance in series to the input or output of the device. Such transients can exceed the absolute maximum ratings of the device if steps are not taken to address the issue. Typical methods for addressing transients include:

- Minimize lead length and inductance into and out of the device.
- Use a large PCB GND plane.
- Use a Schottky diode across the output to absorb negative spikes.
- Use a low-value ceramic capacitor  $C_{IN} = 0.001\text{ }\mu\text{F}$  to  $0.1\text{ }\mu\text{F}$  to absorb the energy and dampen the transients. The approximate value of input capacitance can be estimated with [Equation 20](#):

$$V_{\text{SPIKE(Absolute)}} = V_{IN} + I_{\text{LOAD}} \times \sqrt{\frac{L_{IN}}{C_{IN}}} \tag{20}$$

where

- $V_{IN}$  is the nominal supply voltage
- $I_{\text{LOAD}}$  is the load current
- $L_{IN}$  equals the effective inductance seen looking into the source
- $C_{IN}$  is the capacitance present at the input

NOTE: Systems which need to pass IEC 61000-4-4 tests for immunity to Electrical Fast Transients (EFT) should use a minimum  $C_{IN}$  of  $1\text{ }\mu\text{F}$  to ensure the TPS2596xx does not turn OFF during the EFT burst.

Some applications may require the addition of a Transient Voltage Suppressor (TVS) to prevent transients from exceeding the absolute maximum ratings of the device. The circuit implementation with optional protection components (a ceramic capacitor, TVS and Schottky diode) is shown in [Figure 62](#).

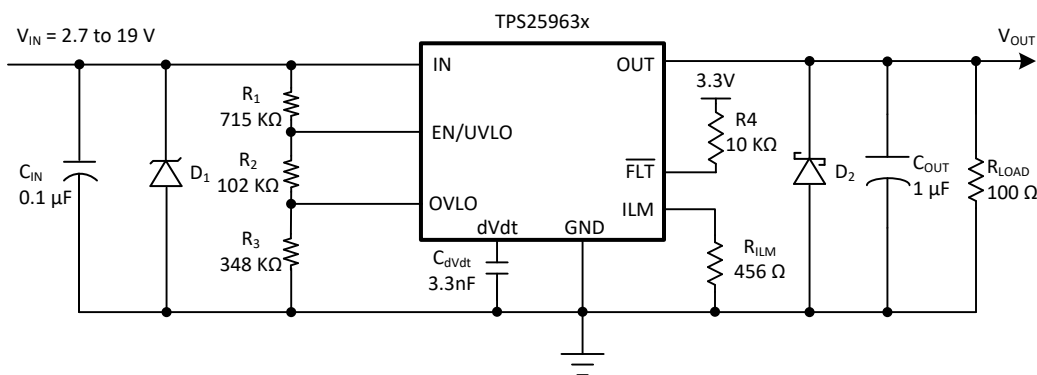

Figure 62. Circuit Implementation with Optional Protection Components

## 10.2 Output Short-Circuit Measurements

It is difficult to obtain repeatable and similar short-circuit testing results. The following contribute to variation in results:

- Source bypassing
- Input leads
- Circuit layout
- Component selection
- Output shorting method
- Relative location of the short
- Instrumentation

The actual short exhibits a certain degree of randomness because it microscopically bounces and arcs. Ensure that configuration and methods are used to obtain realistic results. Do not expect to see waveforms exactly like those in this data sheet because every setup is different.

## 11 Layout

### 11.1 Layout Guidelines

- For all applications, a ceramic decoupling capacitor of 0.01  $\mu\text{F}$  or greater is recommended between the IN terminal and GND terminal. For hot-plug applications, where input power-path inductance is negligible, this capacitor can be eliminated or minimized.
- The optimal placement of the decoupling capacitor is closest to the IN and GND terminals of the device. Care must be taken to minimize the loop area formed by the bypass-capacitor connection, the IN terminal, and the GND terminal of the IC. See [Figure 63](#) for a PCB layout example.
- High current-carrying power-path connections must be as short as possible and must be sized to carry at least twice the full-load current.
- The GND terminal must be tied to the PCB ground plane at the terminal of the IC. The PCB ground must be a copper plane or island on the board.
- Locate the following support components close to their connection pins:
  - $R_{\text{ILM}}$
  - $C_{\text{dVdT}}$
  - Resistor network for the EN/UVLO pin
  - Resistor network for the OVLO pin for TPS25693x variants
  - Pull-down resistor on the OVCSEL pin for TPS25692x variants

Connect the other end of the component to the GND pin of the device with shortest trace length. The trace routing from the  $R_{\text{ILM}}$ ,  $C_{\text{dVdT}}$  and  $R_{\text{OVCSEL}}$  (for TPS25962x variants) components to the device pins must be as short as possible to reduce parasitic effects on the current limit, soft-start timing and overvoltage clamp response. These traces must not have any coupling to switching signals on the board.

- Protection devices such as TVS, snubbers, capacitors, or diodes must be placed physically close to the device they are intended to protect. These protection devices must be routed with short traces to reduce inductance. For example, a protection Schottky diode is recommended to address negative transients due to switching of inductive loads, and it must be physically close to the OUT pins.
- Obtaining acceptable performance with alternate layout schemes is possible. The Layout Example shown in [Figure 63](#) has been shown to produce good results and is intended as a guideline.

## 11.2 Layout Example

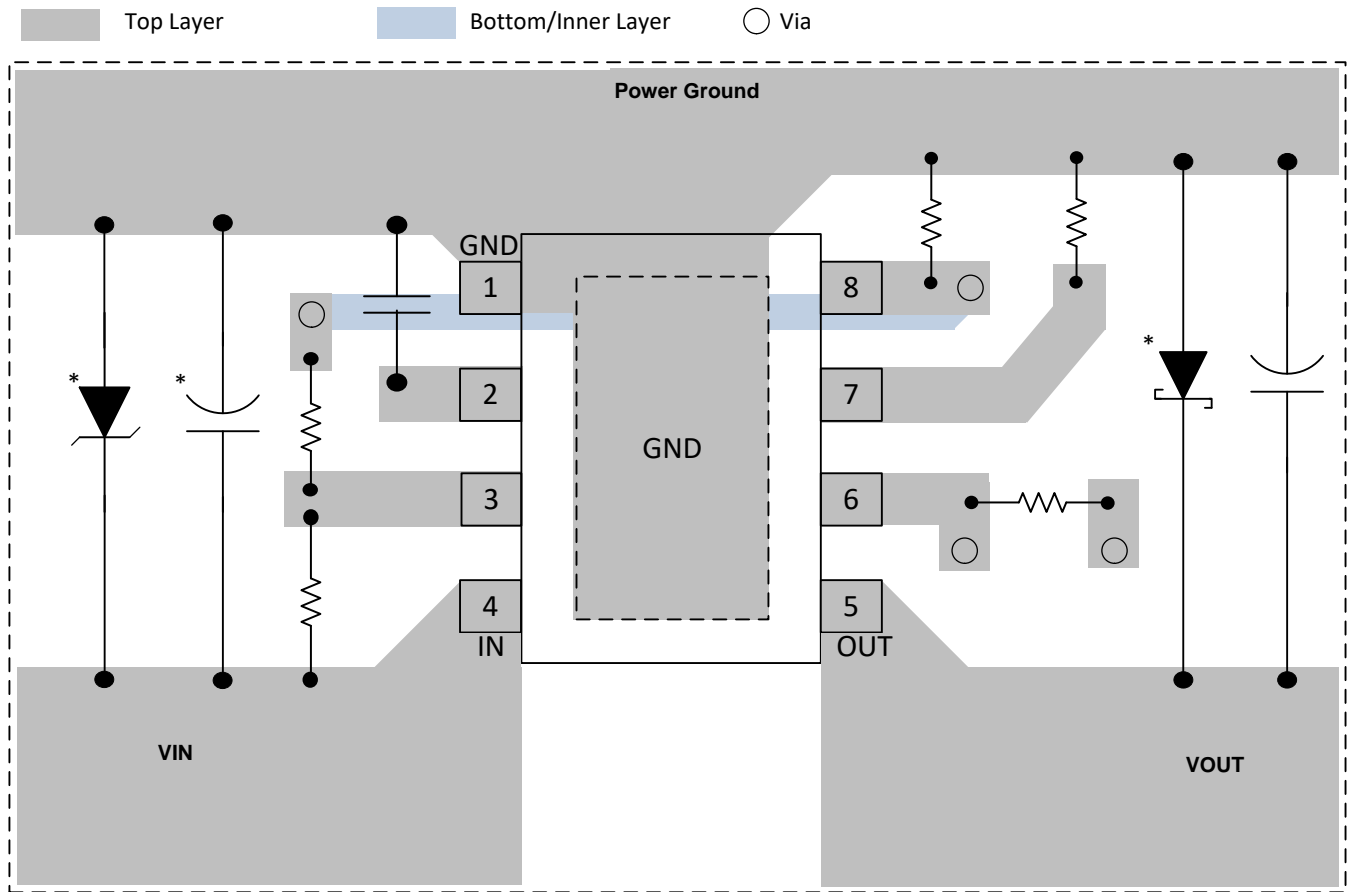

\* Optional: Needed only to suppress the transients caused by inductive load switching

Figure 63. TPS2596xx Layout Example

## 12 Device and Documentation Support

### 12.1 Documentation Support

#### 12.1.1 Related Documentation

For related documentation see the following:

- [Basics of eFuses](#)
- [TPS2596EVM: Evaluation Module for TPS2596xx](#)
- [TPS2596 Design Calculator](#)
- [Designing Low-Power Circuits \(LPCs\) using TPS2596 for Household and similar Appliances](#)
- [TIDA-010037 High Accuracy Split-Phase CT Electricity Meter](#)
- [TIDA-010004 12 V, Highly Protected, Single Driver-Based Stepper, Brushed DC and Actuator Drive](#)

#### 12.2 Receiving Notification of Documentation Updates

To receive notification of documentation updates, navigate to the device product folder on ti.com. In the upper right corner, click on *Alert me* to register and receive a weekly digest of any product information that has changed. For change details, review the revision history included in any revised document.

#### 12.3 Community Resources

The following links connect to TI community resources. Linked contents are provided "AS IS" by the respective contributors. They do not constitute TI specifications and do not necessarily reflect TI's views; see TI's [Terms of Use](#).

**TI E2E™ Online Community** *TI's Engineer-to-Engineer (E2E) Community*. Created to foster collaboration among engineers. At e2e.ti.com, you can ask questions, share knowledge, explore ideas and help solve problems with fellow engineers.

**Design Support** *TI's Design Support* Quickly find helpful E2E forums along with design support tools and contact information for technical support.

#### 12.4 Trademarks

E2E is a trademark of Texas Instruments.  
All other trademarks are the property of their respective owners.

#### 12.5 Electrostatic Discharge Caution



This integrated circuit can be damaged by ESD. Texas Instruments recommends that all integrated circuits be handled with appropriate precautions. Failure to observe proper handling and installation procedures can cause damage.

ESD damage can range from subtle performance degradation to complete device failure. Precision integrated circuits may be more susceptible to damage because very small parametric changes could cause the device not to meet its published specifications.

#### 12.6 Glossary

[SLYZ022](#) — *TI Glossary*.

This glossary lists and explains terms, acronyms, and definitions.

## 13 Mechanical, Packaging, and Orderable Information

The following pages include mechanical, packaging, and orderable information. This information is the most current data available for the designated devices. This data is subject to change without notice and revision of this document. For browser-based versions of this data sheet, refer to the left-hand navigation.

**PACKAGING INFORMATION**

Orderable Device	Status (1)	Package Type	Package Drawing	Pins	Package Qty	Eco Plan (2)	Lead finish/ Ball material (6)	MSL Peak Temp (3)	Op Temp (°C)	Device Marking (4/5)	Samples
TPS259620DDAR	ACTIVE	SO PowerPAD	DDA	8	2500	RoHS & Green	SN	Level-2-260C-1 YEAR	-40 to 125	259620	<a href="#">Samples</a>
TPS259620DDAT	ACTIVE	SO PowerPAD	DDA	8	250	RoHS & Green	SN	Level-2-260C-1 YEAR	-40 to 125	259620	<a href="#">Samples</a>
TPS259621DDAR	ACTIVE	SO PowerPAD	DDA	8	2500	RoHS & Green	SN	Level-2-260C-1 YEAR	-40 to 125	259621	<a href="#">Samples</a>
TPS259621DDAT	ACTIVE	SO PowerPAD	DDA	8	250	RoHS & Green	SN	Level-2-260C-1 YEAR	-40 to 125	259621	<a href="#">Samples</a>
TPS259630DDAR	ACTIVE	SO PowerPAD	DDA	8	2500	RoHS & Green	SN	Level-2-260C-1 YEAR	-40 to 125	259630	<a href="#">Samples</a>
TPS259630DDAT	ACTIVE	SO PowerPAD	DDA	8	250	RoHS & Green	SN	Level-2-260C-1 YEAR	-40 to 125	259630	<a href="#">Samples</a>
TPS259631DDAR	ACTIVE	SO PowerPAD	DDA	8	2500	RoHS & Green	SN	Level-2-260C-1 YEAR	-40 to 125	259631	<a href="#">Samples</a>
TPS259631DDAT	ACTIVE	SO PowerPAD	DDA	8	250	RoHS & Green	SN	Level-2-260C-1 YEAR	-40 to 125	259631	<a href="#">Samples</a>

(1) The marketing status values are defined as follows:

**ACTIVE:** Product device recommended for new designs.

**LIFEBUY:** TI has announced that the device will be discontinued, and a lifetime-buy period is in effect.

**NRND:** Not recommended for new designs. Device is in production to support existing customers, but TI does not recommend using this part in a new design.

**PREVIEW:** Device has been announced but is not in production. Samples may or may not be available.

**OBSELETE:** TI has discontinued the production of the device.

(2) **RoHS:** TI defines "RoHS" to mean semiconductor products that are compliant with the current EU RoHS requirements for all 10 RoHS substances, including the requirement that RoHS substance do not exceed 0.1% by weight in homogeneous materials. Where designed to be soldered at high temperatures, "RoHS" products are suitable for use in specified lead-free processes. TI may reference these types of products as "Pb-Free".

**RoHS Exempt:** TI defines "RoHS Exempt" to mean products that contain lead but are compliant with EU RoHS pursuant to a specific EU RoHS exemption.

**Green:** TI defines "Green" to mean the content of Chlorine (Cl) and Bromine (Br) based flame retardants meet JS709B low halogen requirements of <=1000ppm threshold. Antimony trioxide based flame retardants must also meet the <=1000ppm threshold requirement.

(3) MSL, Peak Temp. - The Moisture Sensitivity Level rating according to the JEDEC industry standard classifications, and peak solder temperature.

(4) There may be additional marking, which relates to the logo, the lot trace code information, or the environmental category on the device.

(5) Multiple Device Markings will be inside parentheses. Only one Device Marking contained in parentheses and separated by a "~" will appear on a device. If a line is indented then it is a continuation of the previous line and the two combined represent the entire Device Marking for that device.

<sup>(6)</sup> Lead finish/Ball material - Orderable Devices may have multiple material finish options. Finish options are separated by a vertical ruled line. Lead finish/Ball material values may wrap to two lines if the finish value exceeds the maximum column width.

**Important Information and Disclaimer:** The information provided on this page represents TI's knowledge and belief as of the date that it is provided. TI bases its knowledge and belief on information provided by third parties, and makes no representation or warranty as to the accuracy of such information. Efforts are underway to better integrate information from third parties. TI has taken and continues to take reasonable steps to provide representative and accurate information but may not have conducted destructive testing or chemical analysis on incoming materials and chemicals. TI and TI suppliers consider certain information to be proprietary, and thus CAS numbers and other limited information may not be available for release.

In no event shall TI's liability arising out of such information exceed the total purchase price of the TI part(s) at issue in this document sold by TI to Customer on an annual basis.

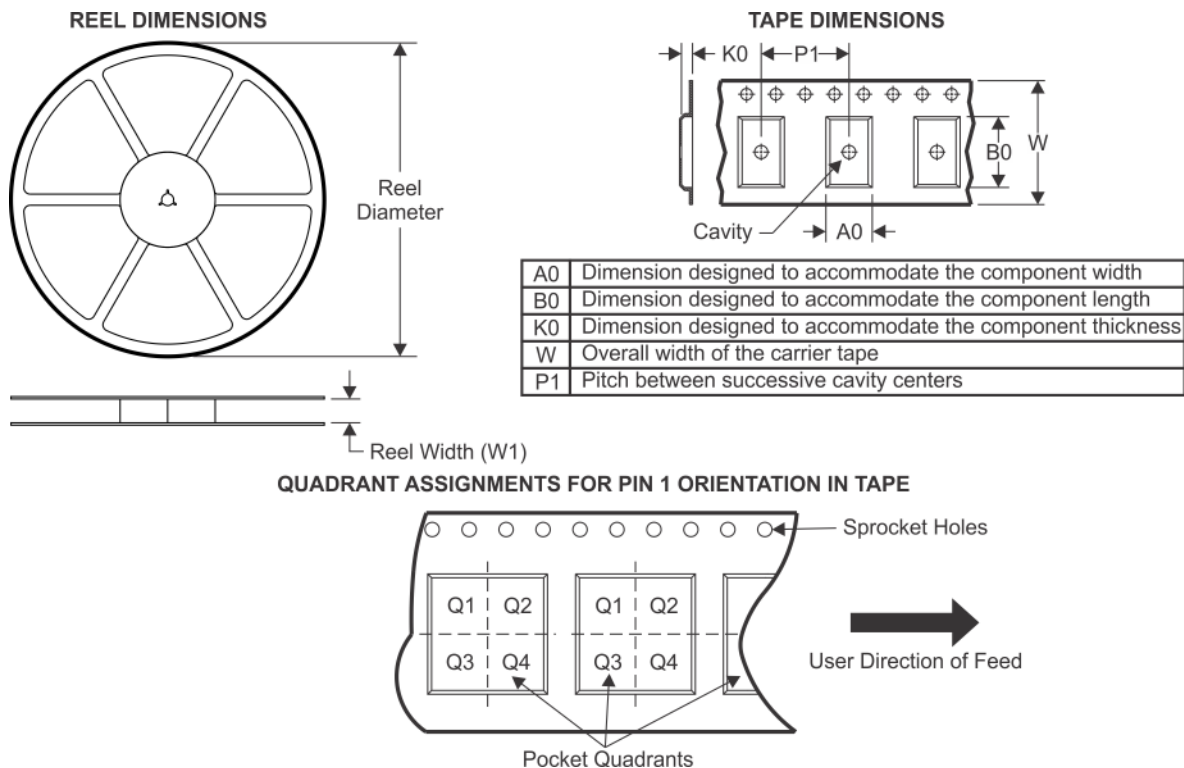

**TAPE AND REEL INFORMATION**

\*All dimensions are nominal

Device	Package Type	Package Drawing	Pins	SPQ	Reel Diameter (mm)	Reel Width W1 (mm)	A0 (mm)	B0 (mm)	K0 (mm)	P1 (mm)	W (mm)	Pin1 Quadrant
TPS259620DDAR	SO Power PAD	DDA	8	2500	330.0	12.8	6.4	5.2	2.1	8.0	12.0	Q1
TPS259620DDAT	SO Power PAD	DDA	8	250	330.0	12.8	6.4	5.2	2.1	8.0	12.0	Q1
TPS259621DDAR	SO Power PAD	DDA	8	2500	330.0	12.8	6.4	5.2	2.1	8.0	12.0	Q1
TPS259621DDAT	SO Power PAD	DDA	8	250	330.0	12.8	6.4	5.2	2.1	8.0	12.0	Q1
TPS259630DDAR	SO Power PAD	DDA	8	2500	330.0	12.8	6.4	5.2	2.1	8.0	12.0	Q1
TPS259630DDAT	SO Power PAD	DDA	8	250	330.0	12.8	6.4	5.2	2.1	8.0	12.0	Q1
TPS259631DDAR	SO Power PAD	DDA	8	2500	330.0	12.8	6.4	5.2	2.1	8.0	12.0	Q1
TPS259631DDAT	SO	DDA	8	250	330.0	12.8	6.4	5.2	2.1	8.0	12.0	Q1

Device	Package Type	Package Drawing	Pins	SPQ	Reel Diameter (mm)	Reel Width W1 (mm)	A0 (mm)	B0 (mm)	K0 (mm)	P1 (mm)	W (mm)	Pin1 Quadrant
	Power PAD											

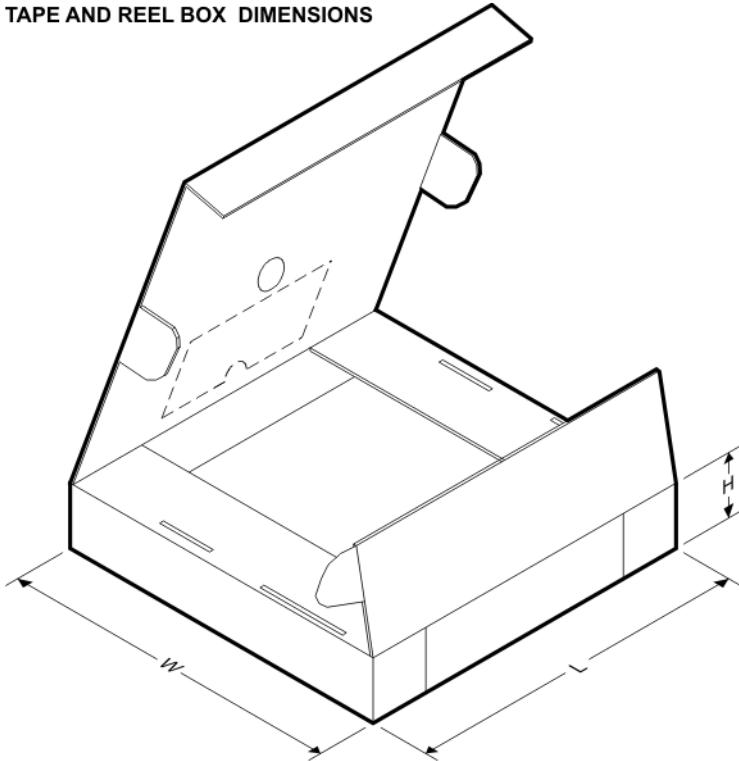
**TAPE AND REEL BOX DIMENSIONS**

\*All dimensions are nominal

Device	Package Type	Package Drawing	Pins	SPQ	Length (mm)	Width (mm)	Height (mm)
TPS259620DDAR	SO PowerPAD	DDA	8	2500	366.0	364.0	50.0
TPS259620DDAT	SO PowerPAD	DDA	8	250	366.0	364.0	50.0
TPS259621DDAR	SO PowerPAD	DDA	8	2500	366.0	364.0	50.0
TPS259621DDAT	SO PowerPAD	DDA	8	250	366.0	364.0	50.0
TPS259630DDAR	SO PowerPAD	DDA	8	2500	366.0	364.0	50.0
TPS259630DDAT	SO PowerPAD	DDA	8	250	366.0	364.0	50.0
TPS259631DDAR	SO PowerPAD	DDA	8	2500	366.0	364.0	50.0
TPS259631DDAT	SO PowerPAD	DDA	8	250	366.0	364.0	50.0

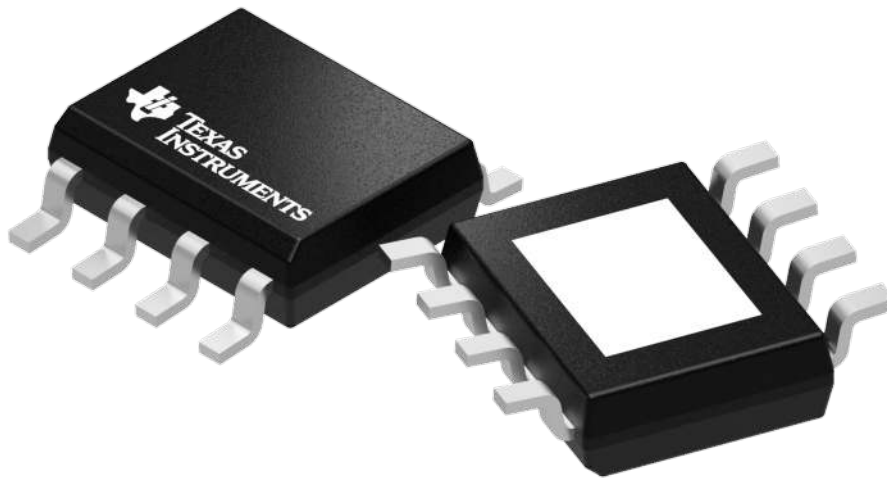

Images above are just a representation of the package family, actual package may vary.  
Refer to the product data sheet for package details.

DDA (R-PDSO-G8)

PowerPAD™ PLASTIC SMALL-OUTLINE

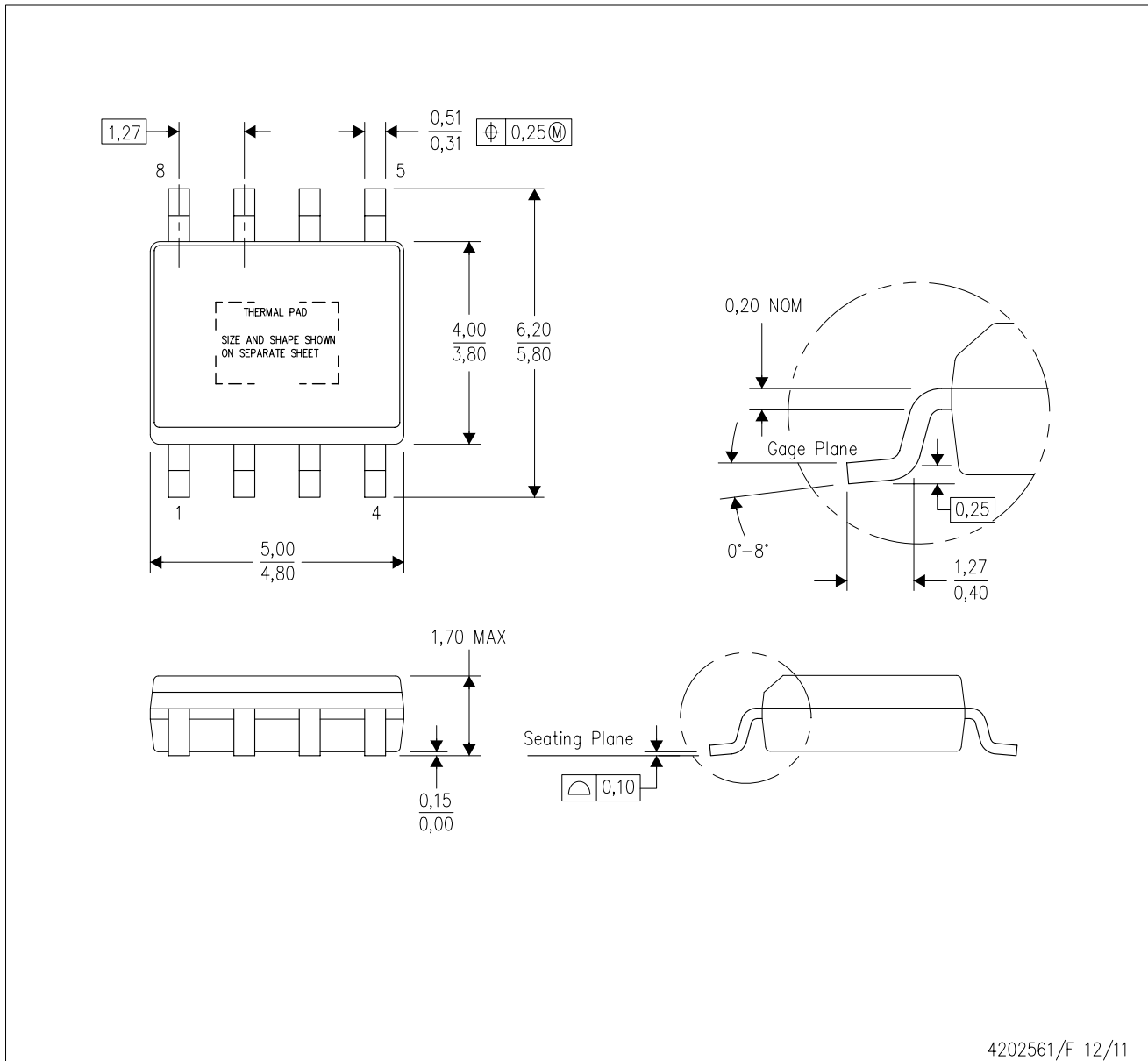

4202561/F 12/11

- NOTES:
- A. All linear dimensions are in millimeters. Dimensioning and tolerancing per ASME Y14.5-1994.
  - B. This drawing is subject to change without notice.
  - C. Body dimensions do not include mold flash or protrusion not to exceed 0,15.
  - D. This package is designed to be soldered to a thermal pad on the board. Refer to Technical Brief, PowerPad Thermally Enhanced Package, Texas Instruments Literature No. SLMA002 for information regarding recommended board layout. This document is available at [www.ti.com](http://www.ti.com) <<http://www.ti.com>>.
  - E. See the additional figure in the Product Data Sheet for details regarding the exposed thermal pad features and dimensions.
  - F. This package complies to JEDEC MS-012 variation BA

PowerPAD is a trademark of Texas Instruments.

DDA (R-PDSO-G8)

PowerPAD™ PLASTIC SMALL OUTLINE

## THERMAL INFORMATION

This PowerPAD™ package incorporates an exposed thermal pad that is designed to be attached to a printed circuit board (PCB). The thermal pad must be soldered directly to the PCB. After soldering, the PCB can be used as a heatsink. In addition, through the use of thermal vias, the thermal pad can be attached directly to the appropriate copper plane shown in the electrical schematic for the device, or alternatively, can be attached to a special heatsink structure designed into the PCB. This design optimizes the heat transfer from the integrated circuit (IC).

For additional information on the PowerPAD package and how to take advantage of its heat dissipating abilities, refer to Technical Brief, PowerPAD Thermally Enhanced Package, Texas Instruments Literature No. SLMA002 and Application Brief, PowerPAD Made Easy, Texas Instruments Literature No. SLMA004. Both documents are available at [www.ti.com](http://www.ti.com).

The exposed thermal pad dimensions for this package are shown in the following illustration.

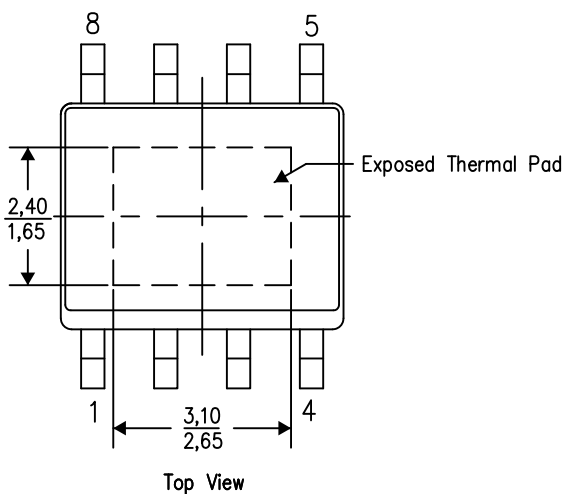

Exposed Thermal Pad Dimensions

4206322-6/L 05/12

NOTE: A. All linear dimensions are in millimeters

PowerPAD is a trademark of Texas Instruments

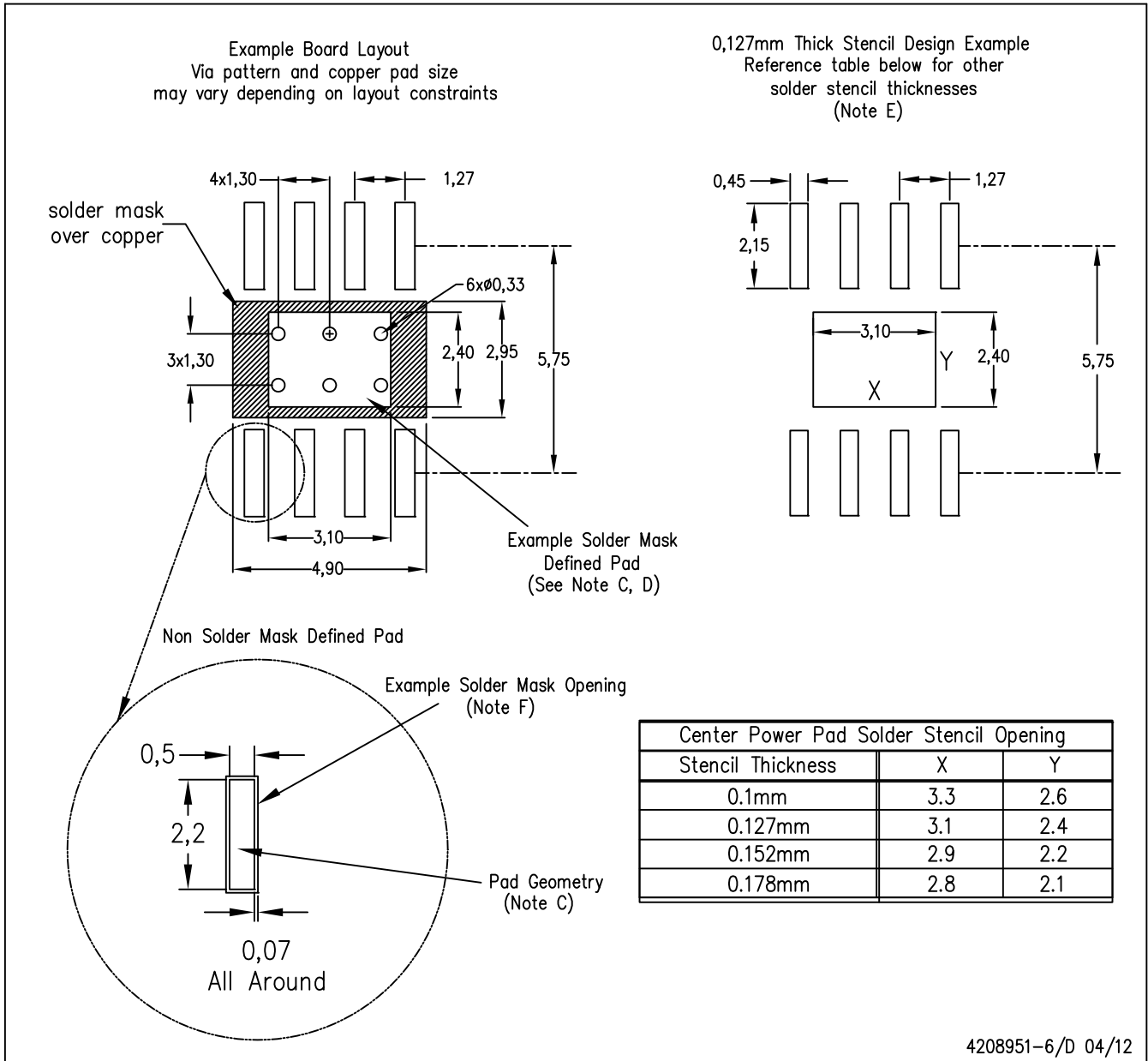

- NOTES:
- A. All linear dimensions are in millimeters.
  - B. This drawing is subject to change without notice.
  - C. Publication IPC-7351 is recommended for alternate designs.
  - D. This package is designed to be soldered to a thermal pad on the board. Refer to Technical Brief, PowerPad Thermally Enhanced Package, Texas Instruments Literature No. SLMA002, SLMA004, and also the Product Data Sheets for specific thermal information, via requirements, and recommended board layout. These documents are available at [www.ti.com](http://www.ti.com) <<http://www.ti.com>>. Publication IPC-7351 is recommended for alternate designs.
  - E. Laser cutting apertures with trapezoidal walls and also rounding corners will offer better paste release. Customers should contact their board assembly site for stencil design recommendations. Example stencil design based on a 50% volumetric metal load solder paste. Refer to IPC-7525 for other stencil recommendations.
  - F. Customers should contact their board fabrication site for solder mask tolerances between and around signal pads.

PowerPAD is a trademark of Texas Instruments.

## IMPORTANT NOTICE AND DISCLAIMER

TI PROVIDES TECHNICAL AND RELIABILITY DATA (INCLUDING DATASHEETS), DESIGN RESOURCES (INCLUDING REFERENCE DESIGNS), APPLICATION OR OTHER DESIGN ADVICE, WEB TOOLS, SAFETY INFORMATION, AND OTHER RESOURCES "AS IS" AND WITH ALL FAULTS, AND DISCLAIMS ALL WARRANTIES, EXPRESS AND IMPLIED, INCLUDING WITHOUT LIMITATION ANY IMPLIED WARRANTIES OF MERCHANTABILITY, FITNESS FOR A PARTICULAR PURPOSE OR NON-INFRINGEMENT OF THIRD PARTY INTELLECTUAL PROPERTY RIGHTS.

These resources are intended for skilled developers designing with TI products. You are solely responsible for (1) selecting the appropriate TI products for your application, (2) designing, validating and testing your application, and (3) ensuring your application meets applicable standards, and any other safety, security, or other requirements. These resources are subject to change without notice. TI grants you permission to use these resources only for development of an application that uses the TI products described in the resource. Other reproduction and display of these resources is prohibited. No license is granted to any other TI intellectual property right or to any third party intellectual property right. TI disclaims responsibility for, and you will fully indemnify TI and its representatives against, any claims, damages, costs, losses, and liabilities arising out of your use of these resources.

TI's products are provided subject to TI's Terms of Sale ([www.ti.com/legal/termsofsale.html](http://www.ti.com/legal/termsofsale.html)) or other applicable terms available either on [ti.com](http://ti.com) or provided in conjunction with such TI products. TI's provision of these resources does not expand or otherwise alter TI's applicable warranties or warranty disclaimers for TI products.

Mailing Address: Texas Instruments, Post Office Box 655303, Dallas, Texas 75265  
Copyright © 2020, Texas Instruments Incorporated