

60 V, 2 x 10 A, low drop power Schottky rectifier

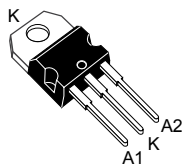

TO-220AB

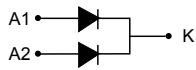
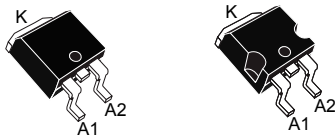

D²PAK

Features

- Low forward voltage drop
- Negligible switching losses
- Low thermal resistance
- Avalanche capability specified
- ECOPACK2 compliant component in TO-220AB, on demand for D²PAK

Applications

- Set-top box
- Battery charger
- DC / DC converter
- Notebook adapter
- Switching diodes

Description

Dual center tab Schottky rectifier suited for SMPS and high frequency DC to DC converters.

Packaged in TO-220AB and D²PAK, the STPS20L60C is intended for use in high frequency inverters.

Product status link

[STPS20L60C](#)

Product summary

Symbol	Value
$I_{F(AV)}$	2 x 10 A
V_{RRM}	60 V
$T_{j(max.)}$	150 °C
$V_{F(typ.)}$	0.48 V

1 Characteristics

Table 1. Absolute ratings (limiting values, per diode, at 25 °C unless otherwise specified)

Symbol	Parameter		Value	Unit	
V _{RRM}	Repetitive peak reverse voltage		60	V	
I _{F(RMS)}	Forward rms current		30	A	
I _{F(AV)}	Average forward current	T _c = 135 °C, δ = 0.5 square wave	Per diode	10	A
			Per device	20	
I _{FSM}	Surge non repetitive forward current		t _p = 10 ms sinusoidal	220	A
P _{ARM}	Repetitive peak avalanche power		t _p = 10 μs, T _j = 125 °C	430	W
T _{stg}	Storage temperature range		-65 to +175	°C	
T _j	Maximum operating junction temperature ⁽¹⁾		150	°C	
dV/dt	Critical rate of rise reverse voltage		10000	V/μs	

1. $(dP_{tot}/dT_j) < (1/R_{th(j-a)})$ condition to avoid thermal runaway for a diode on its own heatsink.

Table 2. Thermal resistance parameters

Symbol	Parameter		Max. value	Unit
R _{th(j-c)}	Junction to case	Per diode	1.6	°C/W
		Total	0.85	
R _{th(c)}	Coupling		0.1	

When the diodes 1 and 2 are used simultaneously :

$$\Delta T_j(\text{diode 1}) = P(\text{diode 1}) \times R_{th(j-c)}(\text{per diode}) + P(\text{diode 2}) \times R_{th(c)}$$

For more information, please refer to the following application note :

- AN5088 : Rectifiers thermal management, handling and mounting recommendations

Table 3. Static electrical characteristics (per diode)

Symbol	Parameter	Test conditions		Min.	Typ.	Max.	Unit
I _R ⁽¹⁾	Reverse leakage current	T _j = 25 °C	V _R = V _{RRM}	-		350	μA
		T _j = 125 °C		-	65	95	mA
V _F ⁽¹⁾	Forward voltage drop	T _j = 25 °C	I _F = 10 A	-		0.60	V
		T _j = 125 °C		-	0.48	0.56	
		T _j = 25 °C	I _F = 20 A	-		0.74	
		T _j = 125 °C		-	0.62	0.70	

1. Pulse test: t_p = 380 μs, δ < 2%

To evaluate the conduction losses, use the following equation:

$$P = 0.42 \times I_{F(AV)} + 0.014 \times I_{F(RMS)}^2$$

For more information, please refer to the following application notes related to the power losses :

- AN604: Calculation of conduction losses in a power rectifier
- AN4021: Calculation of reverse losses on a power diode

1.1 Characteristics (curves)

Figure 1. Average forward current versus case temperature ($\delta = 0.5$, per diode)

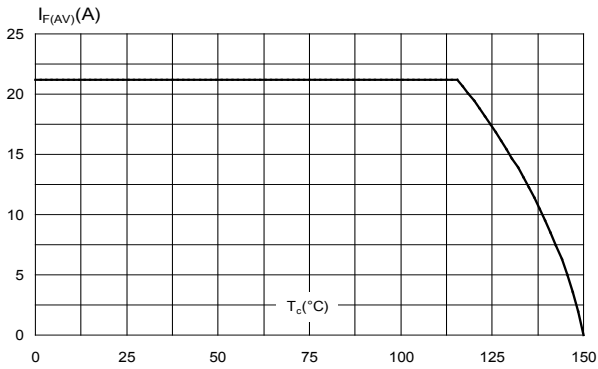

Figure 2. Normalized avalanche power derating versus pulse duration ($T_j = 125^\circ\text{C}$)

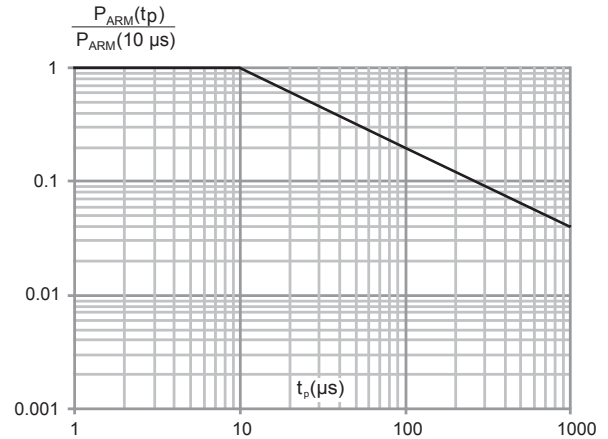

Figure 3. Relative variation of thermal impedance junction to case versus pulse duration

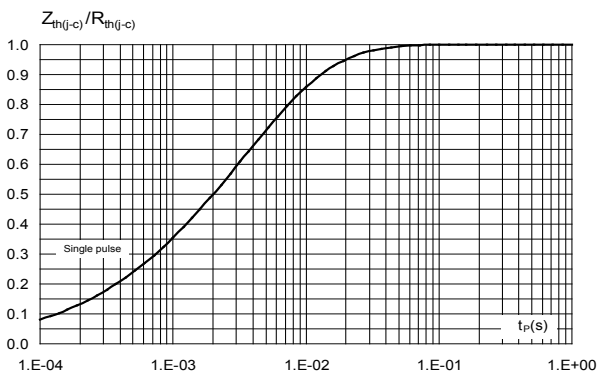

Figure 4. Reverse leakage current versus reverse voltage applied (typical values, per diode)

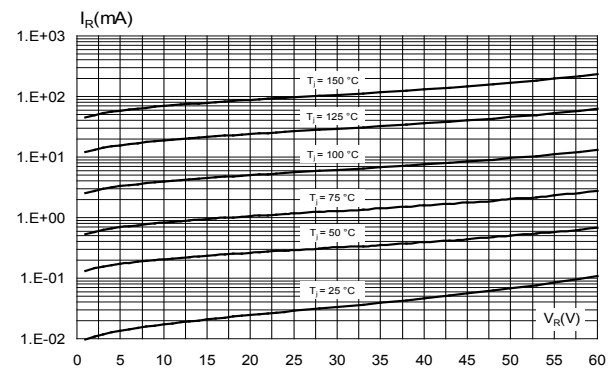

Figure 5. Junction capacitance versus reverse voltage applied (typical values, per diode)

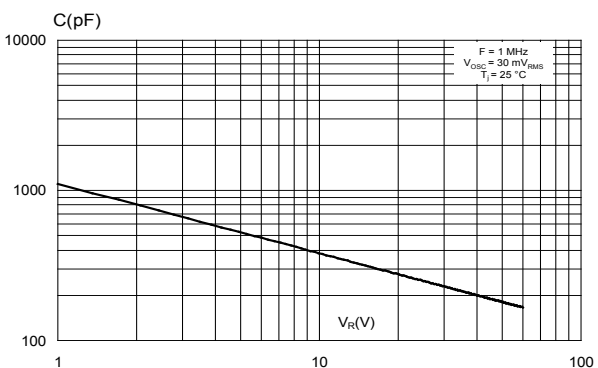

Figure 6. Forward voltage drop versus forward current (typical values, per diode)

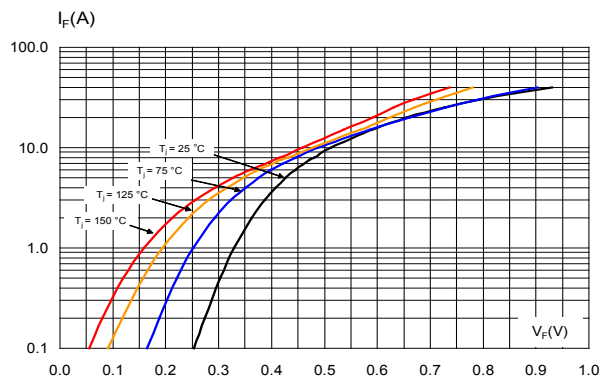
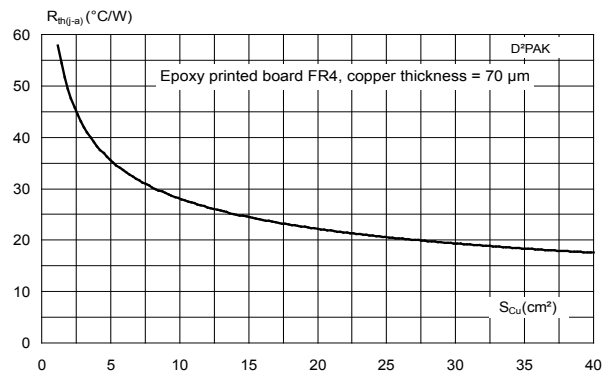

Figure 7. Thermal resistance junction to ambient versus copper surface under tab (typical values)



2 Package information

In order to meet environmental requirements, ST offers these devices in different grades of **ECOPACK** packages, depending on their level of environmental compliance. ECOPACK specifications, grade definitions and product status are available at: www.st.com. ECOPACK is an ST trademark.

2.1 D²PAK package information

- Epoxy meets UL94, V0
- Cooling method: by conduction (C)

Figure 8. D²PAK package outline

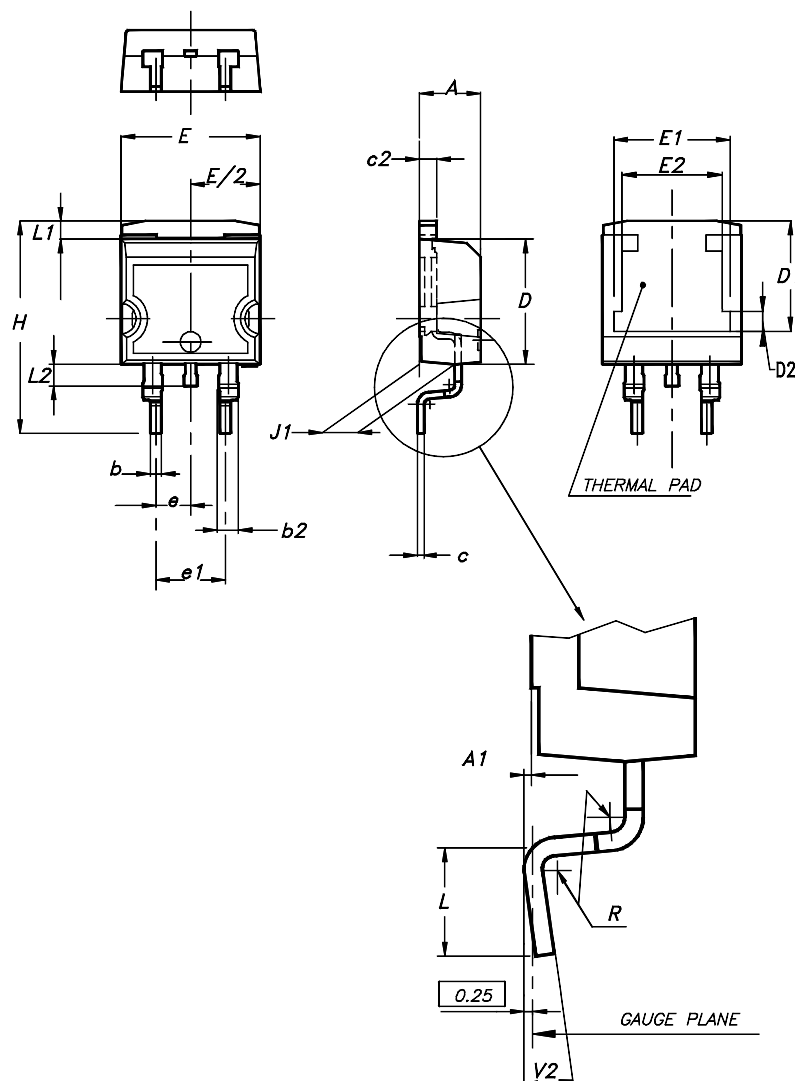

Note: This package drawing may slightly differ from the physical package. However, all the specified dimensions are guaranteed.

Table 4. D²PAK package mechanical data

Ref.	Dimensions			
	Millimeters		Inches (for reference only)	
	Min.	Max.	Min.	Max.
A	4.36	4.60	0.172	0.181
A1	0.00	0.25	0.000	0.010
b	0.70	0.93	0.028	0.037
b2	1.14	1.70	0.045	0.067
c	0.38	0.69	0.015	0.027
c2	1.19	1.36	0.047	0.053
D	8.60	9.35	0.339	0.368
D1	6.90	8.00	0.272	0.311
D2	1.10	1.50	0.043	0.060
E	10.00	10.55	0.394	0.415
E1	8.10	8.90	0.319	0.346
E2	6.85	7.25	0.266	0.282
e	2.54 typ.		0.100	
e1	4.88	5.28	0.190	0.205
H	15.00	15.85	0.591	0.624
J1	2.49	2.90	0.097	0.112
L	1.90	2.79	0.075	0.110
L1	1.27	1.65	0.049	0.065
L2	1.30	1.78	0.050	0.070
R	0.4 typ.		0.015	
V2	0°	8°	0°	8°

Figure 9. D²PAK recommended footprint (dimensions in mm)

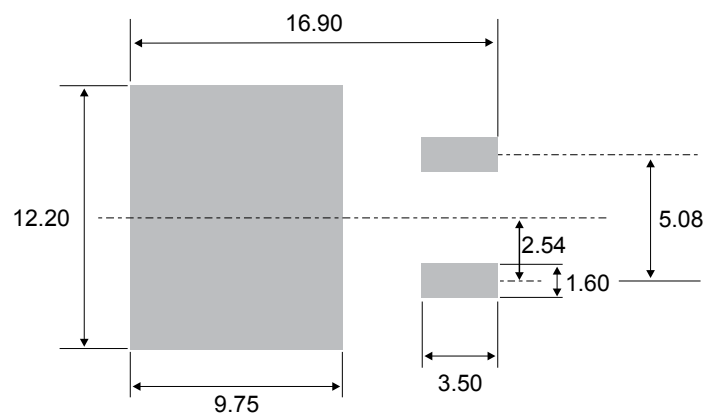

Table 5. TO-220AB package mechanical data

Ref.	Dimensions			
	Millimeters		Inches (for reference only)	
	Min.	Max.	Min.	Max.
A	4.40	4.60	0.173	0.181
b	0.61	0.88	0.240	0.035
b1	1.14	1.55	0.045	0.061
c	0.48	0.70	0.019	0.028
D	15.25	15.75	0.600	0.620
D1	1.27 typ.		0.050 typ.	
E	10.00	10.40	0.394	0.409
e	2.40	2.70	0.094	0.106
e1	4.95	5.15	0.195	0.203
F	1.23	1.32	0.048	0.052
H1	6.20	6.60	0.244	0.260
J1	2.40	2.72	0.094	0.107
L	13.00	14.00	0.512	0.551
L1	3.50	3.93	0.138	0.155
L20	16.40 typ.		0.646 typ.	
L30	28.90 typ.		1.138 typ.	
θP	3.75	3.85	0.148	0.152
Q	2.65	2.95	0.104	0.116

3 Ordering Information

Table 6. Ordering information

Order code	Marking	Package	Weight	Base qty.	Delivery mode
STPS20L60CT	STPS20L60CT	TO-220AB	1.95 g	1000	Tape and reel
STPS20L60CG-TR	STPS20L60CG	D ² PAK	1.48 g	50	Tube

Revision history

Table 7. Document revision history

Date	Version	Changes
Jul-2003	3C	Previous release
02-Aug-2013	4	Added TO-220AB narrow leads package.
02-Dec-2020	5	Removed I ² PAK package information. Updated D ² PAK package information. Added Application section. Minor text change.

IMPORTANT NOTICE – PLEASE READ CAREFULLY

STMicroelectronics NV and its subsidiaries (“ST”) reserve the right to make changes, corrections, enhancements, modifications, and improvements to ST products and/or to this document at any time without notice. Purchasers should obtain the latest relevant information on ST products before placing orders. ST products are sold pursuant to ST’s terms and conditions of sale in place at the time of order acknowledgement.

Purchasers are solely responsible for the choice, selection, and use of ST products and ST assumes no liability for application assistance or the design of Purchasers’ products.

No license, express or implied, to any intellectual property right is granted by ST herein.

Resale of ST products with provisions different from the information set forth herein shall void any warranty granted by ST for such product.

ST and the ST logo are trademarks of ST. For additional information about ST trademarks, please refer to www.st.com/trademarks. All other product or service names are the property of their respective owners.

Information in this document supersedes and replaces information previously supplied in any prior versions of this document.

© 2020 STMicroelectronics – All rights reserved