



## Crystal Clock Oscillator Specification

IQD Part No. + Packaging: LFSPX0018545Reel

Würth Part No. 831018545



### Description

- Standard 7 x 5mm crystal oscillator in a ceramic package with a seam sealed metal lid, hermetically sealed.
- Model CFPS-73
- Model Issue number 13

### Frequency Parameters

- Frequency 60.0MHz
- Frequency Stability  $\pm 50.00\text{ppm}$
- Operating Temperature Range 0.00 to 70.00°C
- Ageing  $\pm 3\text{ppm per year max}$

### Electrical Parameters

- Supply Voltage 3.3V  $\pm 10\%$
- Current Draw 25.000mA
- Note: parameters are referenced to 15pF load

### Output Details

- Output Compatibility HCMOS
- Drive Capability 15pF std, 30pF max
- Rise and Fall Time 8.0ns max
- Duty Cycle 45/55

### Output Control

- Standby Operation:  
Logic '1' (>70% VS) to pad 1 enables oscillator output  
Logic '0' (<30% VS) to pad 1 disables oscillator output; the oscillator output goes to the high impedance state  
No connection to pad 1 enables oscillator output  
Standby Current: 10 $\mu$ A max

### Noise Parameters

- Phase Noise @125MHz (typical):  
10Hz -54dBc  
100Hz -92dBc  
1kHz -130dBc  
10kHz -149dBc  
100kHz -159dBc  
1MHz -163dBc
- RMS Phase Jitter @125MHz: 52fs typical

### Environmental Parameters

- Shock: MIL-STD-202, Method 213, Condition E
- Vibration: MIL-STD-883, Method 2007, Condition A
- Storage Temperature Range: -55 to 125°C

### Manufacturing Details

- RoHS Terminations NiAu
- RoHS Reflow Temp 260degC 10s

### Compliance

- RoHS Status (2011/65/EU) Compliant
- REACH Status Compliant
- MSL Rating (JDEC-STD-033): Not Applicable



### Outline (mm)

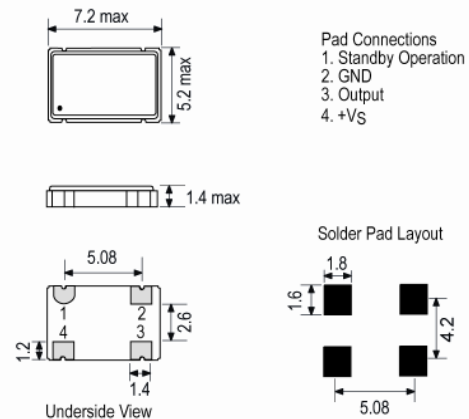

### Test Circuit

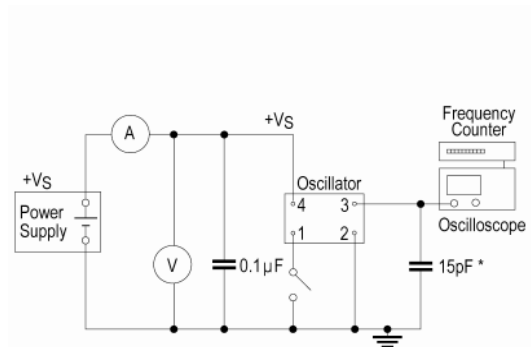

\* Inclusive of jigging and equipment capacitance

### CONTACT INFORMATION:

Würth Elektronik eiSos GmbH & Co. KG  
Max-Eyth-Str. 1, 74638 Waldenburg, Germany  
Tel: +49(0) 7942 945-0

Email: eiSos@we-online.de  
Web: www.we-online.com



## Crystal Clock Oscillator Specification

IQD Part No. + Packaging: LFSPX0018545Reel

Würth Part No. 831018545



### Packaging Details

- Pack Style: Reel     Tape & reel in accordance with EIA-481-D  
Pack Size: 1,000
- Alternative packing option available

### USEFUL LINKS

#### Toolbox:

[www.we-online.com/toolbox](http://www.we-online.com/toolbox)

#### Product Catalog:

[www.we-online.com/products](http://www.we-online.com/products)

### Wave Form

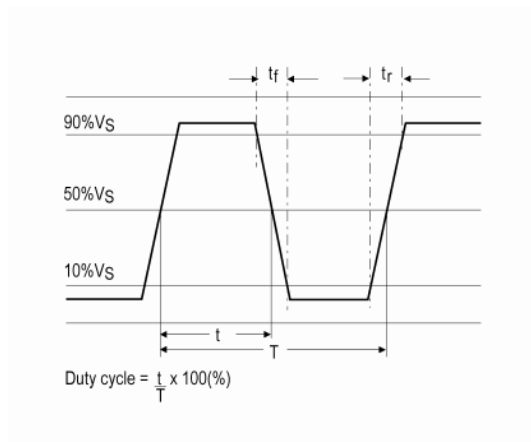

### Phase Noise / Jitter

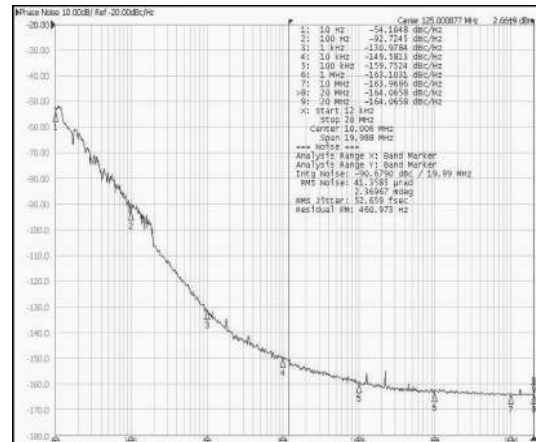

### CONTACT INFORMATION:

Würth Elektronik eiSos GmbH & Co. KG  
Max-Eyth-Str. 1, 74638 Waldenburg, Germany  
Tel: +49(0) 7942 945-0

Email: [eiSos@we-online.de](mailto:eiSos@we-online.de)  
Web: [www.we-online.com](http://www.we-online.com)