





# SPECIFICATIONS

**CUSTOMER** : \_\_\_\_\_  
**MODEL NO.** : **GFE144032E-YPOE08**  
**VERSION** : **B**  
**DATE** : **2022.12.02**  
**CERTIFICATION** : **ROHS**

Customer Sign	Approved By	Prepared By	Prepared By
			

晶發科技股份有限公司  
GI FAR TECHNOLOGY CO.,LTD

新北市樹林區東豐街 81 號

No. 81, Dongfeng St, Shulin District, 238034, New Taipei City, Taiwan, R.O.C.

TEL: +886-2-8684-1188 FAX: +886-2-8684-8532



## Revision Record

Data(y/m/d)	Ver.	Description	page
2020.03.09	A	依 GFE144032E-YPOE 變更 BOM, R7→NC ; R12→3K/0805,新編號 GFE144032E-YPOE08	
2022.12.02	B	更新公司抬頭認證圖示	



## CONTENTS

1. Scope	-----	4
2. Product Specifications	-----	4
2.1 General	-----	4
2.2 Mechanical Characteristics	-----	4
2.3 Absolute Maximum Ratings	-----	5
2.4 Electrical Characteristics	-----	5
2.5 Optical Characteristics Absolute maximum ratings	-----	5
2.6 Optical Characteristics	-----	6
2.7 LED Back-light Characteristics	-----	7
3. Reliability	-----	8
4. Operating Instructions	-----	9
4.1 Input signal Function	-----	9
4.2 Timing Diagram	-----	10
4.3 Display Command	-----	11
4.4 Circuit Block Diagram	-----	13
5. Notes	-----	14
6. Operation Precautions	-----	14
7. LCM Dimensions	-----	15
8. Font Code Table	-----	16
9. Package Information	-----	24
Appendix : Inspection Standard		



## 1. SCOPE

This specification covers the engineering requirements for the GFE144032E-YPOE08 liquid crystal module.

## 2. PRODUCT SPECIFICATIONS

### 2.1 General

- 144 × 32 dot matrix LCD
- STN (Yellow-Green), Positive mode LCD panel
- Transflective Wide temperature type
- 6 o'clock
- Multiplexing driving : 1/33duty, 1/6bias
- Controller IC : ST7920-0A or Compatible
- Backlight: Yellow-Green

### 2.2 Mechanical Characteristics

Item	Value	Unit
Number of dots	144X32	Dot
Dot size	0.39X0.39	mm
Dot pitch	0.42X0.42	mm
Module dimension	80(W)X36(H)X12.2(T)	mm
Viewing Area	64.5(W)X16(H)	mm
Active Area	60.45(W) X 13.41(H)	mm
Module	No Connector	
Remark	R7→NC ; R12 → 3K/0805	



### 2.3 Absolute Maximum Ratings (Without LED back-light)

Characteristic	Symbol	Unit	Value
Operating Voltage (logic)	$V_{DD}$	V	-0.3 to +5.5
Input Voltage	$V_{IN}$	V	-0.3 to $V_{DD}+0.3$

Note 1: Referenced to  $V_{SS}=0V$

### 2.4 Electrical Characteristics (Without LED back-light)

Characteristic	Symbol	Condition	Min.	Typ.	Max.	Unit
Operating Voltage (logic)	$V_{DD}-V_{SS}$	--	4.7	5.0	5.3	V
Input Voltage	$V_{IH}$	--	$0.8V_{DD}$	--	$V_{DD}$	V
	$V_{IL}$	--	$V_{SS}$	--	$0.2V_{DD}$	
Output Voltage	$V_{OH}$	$I_{OH}=-0.1mA$	$0.8V_{DD}$	--	$V_{DD}$	V
	$V_{HL}$	$I_{OL}=0.1mA$	$V_{SS}$	--	$0.2V_{DD}$	

### 2.5 Optical Characteristics Absolute maximum ratings

Item	Symbol	Rating	Unit
Operating temperature range	Top	-20~70	°C
Storage temperature range	Tst	-30~80	°C



## 2.6. Optical Characteristics

1/33 duty, 1/6 bias,  $V_{op}=4.2\text{ V}$ ,  $T_a=25^\circ\text{C}$

Item	Symbol	Conditions	Min.	Typ.	Max	Reference
Driving voltage	$V_{op}$		3.9	4.2	4.5	
Viewing angle	$\theta_1 \cdot \theta_2$	$C \geq 2.0, \phi = 0^\circ\text{C}$	$30^\circ$	-	-	Notes 1 & 2
Contrast	C	$\theta = 5^\circ, \phi = 0^\circ$	2.0	-	-	Note 3
Response time(rise)	$t_{on}$	$\theta = 5^\circ, \phi = 0^\circ$	-	250	300ms	Note 4
Response time(fall)	$t_{off}$	$\theta = 5^\circ, \phi = 0^\circ$	-	250	350ms	Note 4

Note 1: Definition of angles  $\theta$  and  $\phi$

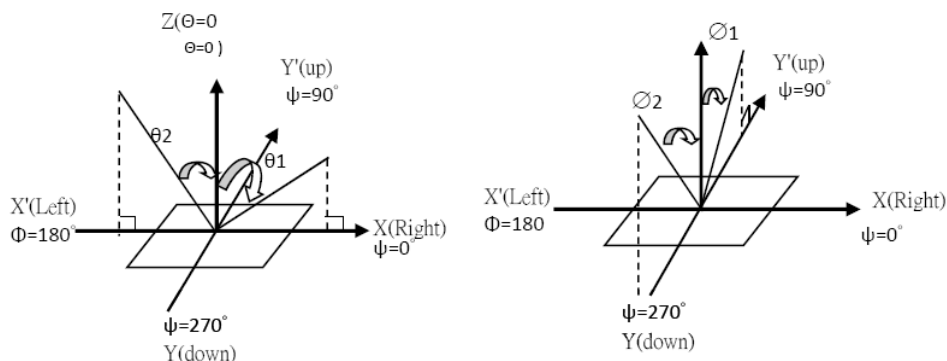

Note 2: Definition of viewing angles  $\theta_1$  and  $\theta_2$

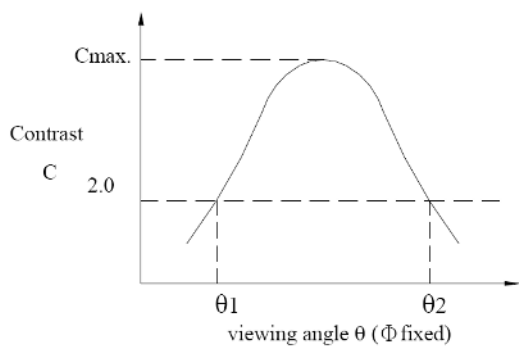

Note : Optimum viewing angle with the naked eye and viewing angle  $\theta$  at  $C_{max}$ . Above are not always the same

Note 3: Definition of contrast C

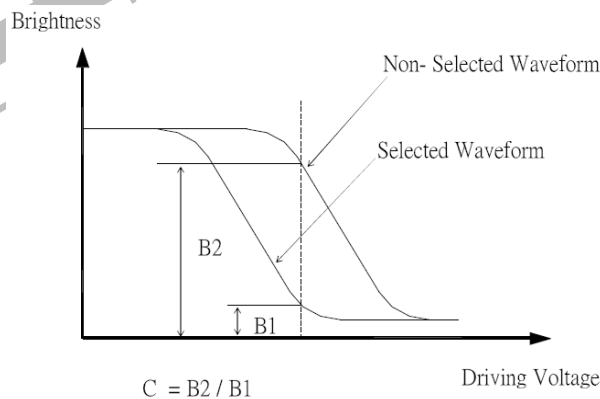

Note 4: Definition of response time

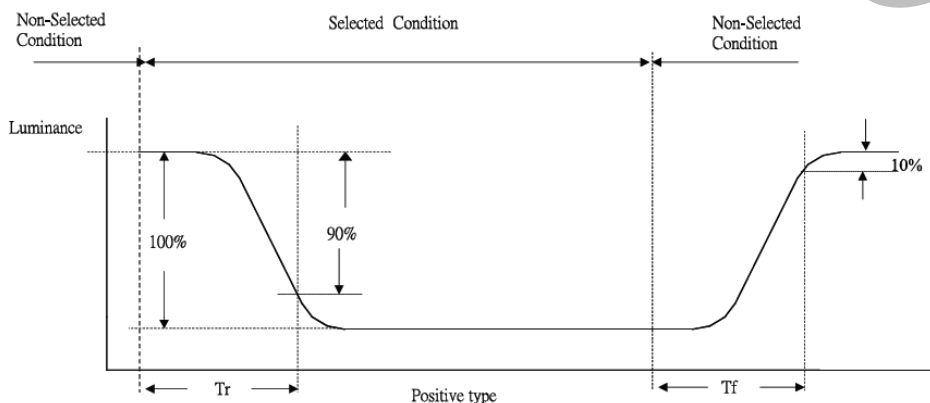



## 2.7 LED Back-light Characteristics

### 2.7.1 Electrical / optical specifications

Ta = 25°C

Item	Symbol	Condition	Min.	Typ.	Max.	Unit
Forward voltage	V <sub>f</sub>	I <sub>f</sub> =130mA, Yellow Green	3.8	4.2	4.5	V
*Luminous Intensity	I <sub>v</sub>	I <sub>f</sub> =130mA, Yellow Green	150	180	--	cd/m <sup>2</sup>
Peak Emission Wavelength	λ <sub>P</sub>	I <sub>f</sub> =130mA, Yellow Green	567	572	577	nm
Reverse Current	I <sub>R</sub>	V <sub>R</sub> =5V, Yellow Green	--	--	--	uA
Luminous Uniformity	ΔL <sub>v</sub>	I <sub>f</sub> =130mA, Yellow Green	70			%

Note: \* Measured at the bare LED back-light unit.

### 2.7.2 LED Maximum Operating Range

Item	Symbol	Yellow-Green	Unit
Power Dissipation	P <sub>AD</sub>	858	mW
Forward Current	I <sub>F</sub>	195	mA
Reverse Voltage	V <sub>R</sub>	5	V



### 3. RELIABILITY

NO.	ITEM	CONDITION		STANDARD	NOTE
1	High Temp. Storage	80°C	120 hrs	Appearance Without defect	
2	Low Temp. Storage	-30°C	120 hrs	Appearance Without defect	
3	High Temp. & High Humi. Storage	40°C 90% RH	120 hrs	Appearance Without defect	
4	High Temp. Operating Display	70°C	120 hrs	Appearance Without defect	
5	Low Temp. Operating Display	-20°C	120 hrs	Appearance Without defect	
6	Thermal Shock	-20°C, 30min. → 70°C, 30min. ↑ (1cycle)		Appearance Without defect	10 cycles

\*\* Dissipation current, contrast and display functions

\*\* Polarizing filter deterioration, other appearance defects

\*\* The function test shall be conducted after 4hours storage at the normal temperature and humidity after remove from the test chamber.





## 4. OPERATING INSTRUCTIONS

### 4.1 Input signal Function

NO.	Symbol	Function
1	VSS	Ground (0V)
2	VDD	Power supply for Logic circuit
3	NC	NC
4	RS	Data / Instruction select
5	R/W	Read / Write select
6	E	Enable signal
7-14	DB0-DB7	Data Bus line
15	LED A	Power supply for LED
16	LED K	Power supply for LED



## 4.2 Timing Diagram

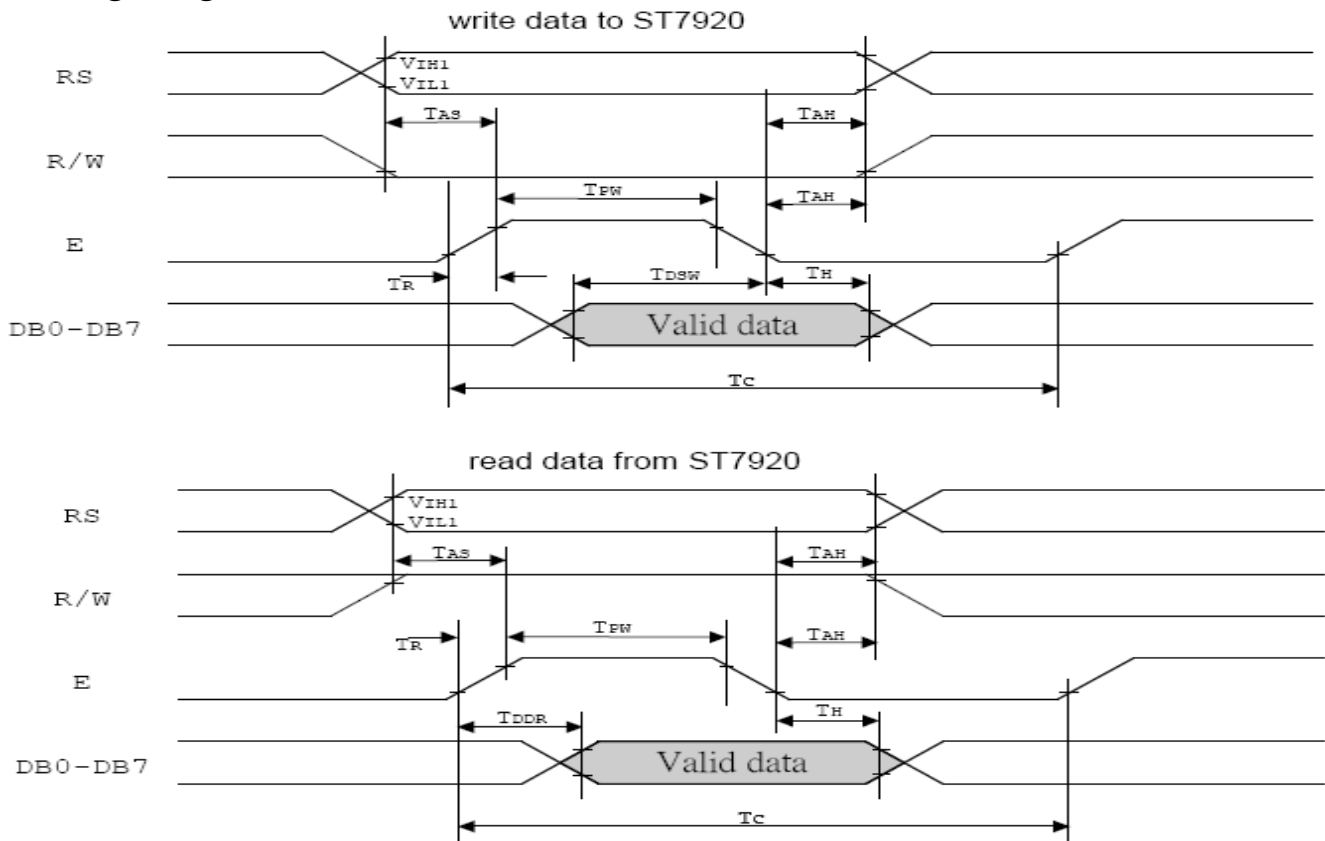

Symbol	Characteristics	Test Condition	Min.	Typ.	Max.	Unit
<i>Internal Clock Operation</i>						
$f_{OSC}$	OSC Frequency	R = 33K $\Omega$	480	540	600	KHz
<i>External Clock Operation</i>						
$f_{EX}$	External Frequency	-	480	540	600	KHz
	Duty Cycle	-	45	50	55	%
$T_{R}, T_{F}$	Rise/Fall Time	-	-	-	0.2	$\mu$ S
<i>Write Mode (Writing data from MPU to ST7920)</i>						
$T_C$	Enable Cycle Time	Pin E	1200	-	-	ns
$T_{PW}$	Enable Pulse Width	Pin E	140	-	-	ns
$T_{R}, T_{F}$	Enable Rise/Fall Time	Pin E	-	-	25	ns
$T_{AS}$	Address Setup Time	Pins: RS,RW,E	10	-	-	ns
$T_{AH}$	Address Hold Time	Pins: RS,RW,E	20	-	-	ns
$T_{DSW}$	Data Setup Time	Pins: DB0 - DB7	40	-	-	ns
$T_H$	Data Hold Time	Pins: DB0 - DB7	20	-	-	ns
<i>Read Mode (Reading Data from ST7920 to MPU)</i>						
$T_C$	Enable Cycle Time	Pin E	1200	-	-	ns
$T_{PW}$	Enable Pulse Width	Pin E	140	-	-	ns
$T_{R}, T_{F}$	Enable Rise/Fall Time	Pin E	-	-	25	ns
$T_{AS}$	Address Setup Time	Pins: RS,RW,E	10	-	-	ns
$T_{AH}$	Address Hold Time	Pins: RS,RW,E	20	-	-	ns
$T_{DDR}$	Data Delay Time	Pins: DB0 - DB7	-	-	100	ns
$T_H$	Data Hold Time	Pins: DB0 - DB7	20	-	-	ns



### 4.3 Display Command

#### Instruction set 1: (RE=0: basic instruction)

Ins	code										Description	Exec time (540KHZ)
	RS	RW	DB7	DB6	DB5	DB4	DB3	DB2	DB1	DB0		
CLEAR	0	0	0	0	0	0	0	0	0	1	Fill DDRAM with "20H", and set DDRAM address counter (AC) to "00H"	1.6 ms
HOME	0	0	0	0	0	0	0	0	0	1 X	Set DDRAM address counter (AC) to "00H", and put cursor to origin ; the content of DDRAM are not changed	72us
ENTRY MODE	0	0	0	0	0	0	0	0	1	I/D S	Set cursor position and display shift when doing write or read operation	72us
DISPLAY ON/OFF	0	0	0	0	0	0	0	1	D	C B	D=1: display ON C=1: cursor ON B=1: blink ON	72 us
CURSOR DISPLAY CONTROL	0	0	0	0	0	1	S/C	R/L	X	X	Cursor position and display shift control ; the content of DDRAM are not changed	72 us
FUNCTION SET	0	0	0	0	1	DL	X	0	X	X	DL=1 8-BIT interface DL=0 4-BIT interface <b>RE=1: extended instruction</b> <b>RE=0: basic instruction</b>	72 us
SET CGRAM ADDR.	0	0	0	1	AC5	AC4	AC3	AC2	AC1	AC0	Set CGRAM address to address counter (AC) <b>Make sure that in extended instruction SR=0 (scroll or RAM address select)</b>	72 us
SET DDRAM ADDR.	0	0	1	0	AC5	AC4	AC3	AC2	AC1	AC0	Set DDRAM address to address counter (AC) AC6 is fixed to 0	72 us
READ BUSY FLAG (BF) & ADDR.	0	1	BF	AC6	AC5	AC4	AC3	AC2	AC1	AC0	Read busy flag (BF) for completion of internal operation, also Read out the value of address counter (AC)	0 us
WRITE RAM	1	0	D7	D6	D5	D4	D3	D2	D1	D0	Write data to internal RAM (DDRAM/CGRAM/GDRAM)	72 us
READ RAM	1	1	D7	D6	D5	D4	D3	D2	D1	D0	Read data from internal RAM (DDRAM/CGRAM/GDRAM)	72 us



## Instruction set 2: (RE=1: extended instruction)

Inst.	code										description	Exec. time (540KHZ)
	RS	RW	DB7	DB6	DB5	DB4	DB3	DB2	DB1	DB0		
STAND BY	0	0	0	0	0	0	0	0	0	1	Enter stand by mode, any other instruction can terminate (Com1..32 halted)	72 us
SCROLL or RAM ADDR. SELECT	0	0	0	0	0	0	0	0	1	SR	SR=1: enable vertical scroll position SR=0: enable CGRAM address( <b>basic instruction</b> )	72 us
REVERSE	0	0	0	0	0	0	0	1	R1	R0	Select 1 out of 4 line ( in DDRAM) and decide whether to reverse the display by toggling this instruction <b>R1,R0 initial value is 00</b>	72 us
EXTENDED FUNCTION SET	0	0	0	0	1	DL	X	1 RE	G	0	DL=1 8-BIT interface DL=0 4-BIT interface <b>RE=1: extended instruction set</b> <b>RE=0: basic instruction set</b> G=1 :graphic display ON G=0 :graphic display OFF	72 us
SET IRAM or SCROLL ADDR	0	0	0	1	AC5	AC4	AC3	AC2	AC1	AC0	SR=1: AC5~AC0 the address of vertical scroll	72 us
SET GRAPHIC RAM ADDR.	0	0	1	0 0	0 AC5	0 AC4	AC3 AC3	AC2 AC2	AC1 AC1	AC0 AC0	Set GDRAM address to address counter ( AC ) First set vertical address and the horizontal address by consecutive writing Vertical address range AC5...AC0 Horizontal address range AC3...AC0	72 us

## Initial setting(Register flag) (RE=0: basic instruction)

Inst.	code										Description
	RS	RW	DB7	DB6	DB5	DB4	DB3	DB2	DB1	DB0	
ENTRY MODE SET	0	0	0	0	0	0	0	1	I/D	S	Cursor move to right ,DDRAM address counter ( AC ) plus 1
									1	0	
DISPLAY STATUS	0	0	0	0	0	0	1	D	C	B	Display, cursor and blink ALL OFF
								0	0	0	
CURSOR DISPLAY SHIFT	0	0	0	0	0	1	S/C	R/L	X	X	No cursor or display shift operation
							X	X			
FUNCTION SET	0	0	0	0	1	DL	X	0 RE	X	X	8 BIT MPU interface , basic instruction set
					1			0			



Initial setting(Register flag) (RE=1: extended instruction set)

Inst.	code										description
	RS	RW	DB7	DB6	DB5	DB4	DB3	DB2	DB1	DB0	
SCROLL OR RAM ADDR. SELECT	0	0	0	0	0	0	0	0	1	SR	Allow IRAMaddress or set CGRAM address
										0	
REVERSE	0	0	0	0	0	0	0	1	R1	R0	Begin with normal and toggle to reverse
									0	0	
EXTENDED FUNCTION SET	0	0	0	0	1	DL	X	1 RE	G	0	Graphic display OFF
									0		

4.4 Circuit Block Diagram

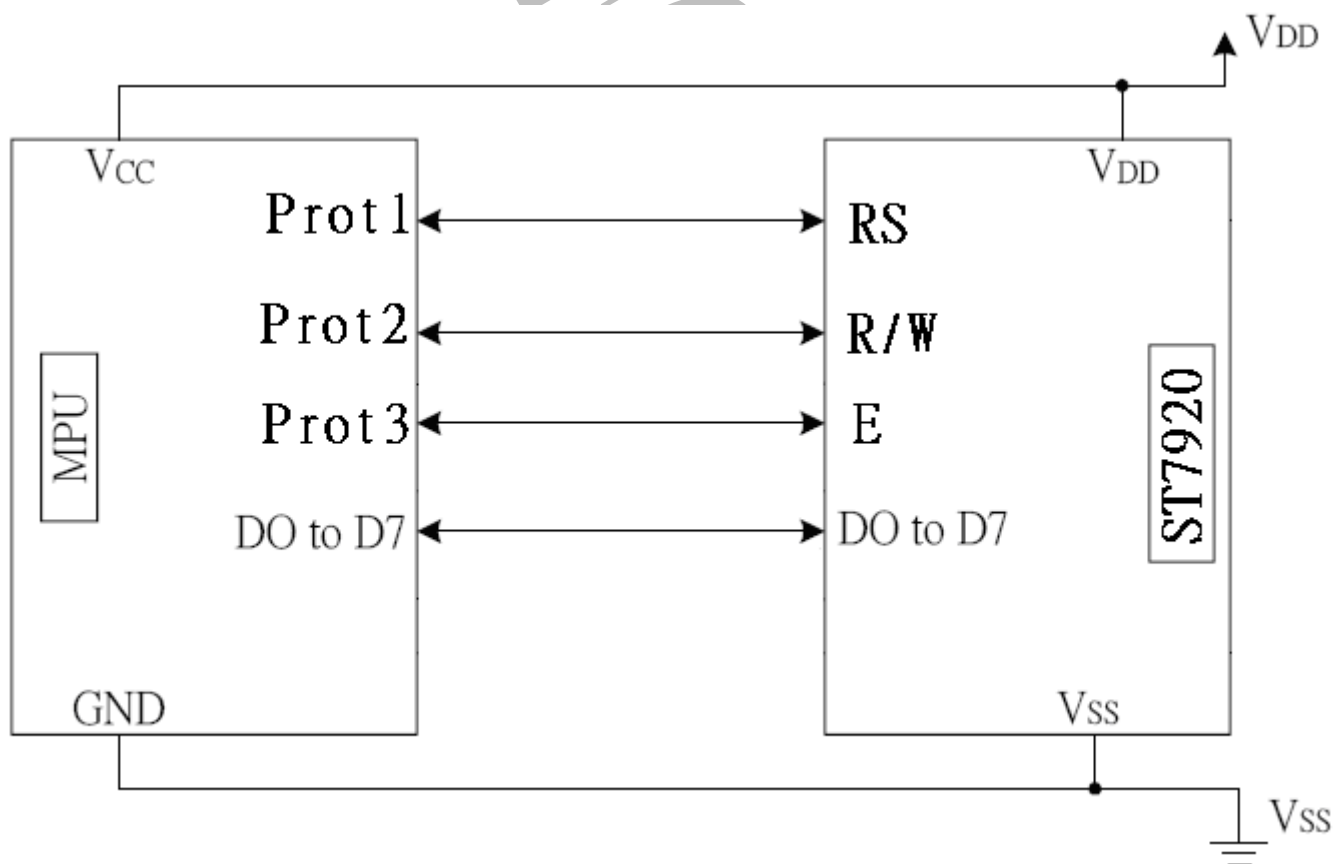



## 5. NOTES

### ▪ Safety

- If the LCD panel breaks, be careful not to get the liquid crystal in your mouth. If the liquid crystal touches your skin or clothes, wash it off immediately using soap and plenty of water.

### Handling

- Avoid static electricity as this can damage the CMOS LSI.
- The LCD panel is plate glass; do not hit or crush it.
- Do not remove the panel or frame from the module.
- The polarizing plate of the display is very fragile; handle it very carefully

### Mounting and Design

- Mount the module by using the specified mounting part and holes.
- To protect the module from external pressure, leave a small gap by placing transparent plates (e.g. acrylic or glass ) on the display surface, frame, and polarizing plate
- Design the system so that no input signal is given unless the power-supply voltage is applied.
- Keep the module dry. Avoid condensation, otherwise the transparent electrodes may break.

### Storage

- Store the module in a dark place where the temperature is  $25\text{ }^{\circ}\text{C}\pm 10\text{ }^{\circ}\text{C}$  and the humidity below 65% RH.
- Do not store the module near organic solvents or corrosive gases.
- Do not crush, shake, or jolt the module (including accessories).

### Cleaning

- Do not wipe the polarizing plate with a dry cloth, as it may scratch the surface.
- Wipe the module gently with soft cloth soaked with a petroleum benzene.
- Do not use ketonic solvents (ketone and acetone) or aromatic solvents (toluene and xylene), as they may damage the polarizing plate.

### Quality warranty period

- Within one year after shipment date. ( excluding abnormal usage way and abnormal environments. )

## 6. OPERATION PRECAUTIONS

Any changes that need to be made in this specification or any problems arising from it will be dealt with quickly by discussion between both companies.

Quality warranty period: Within one year after shipment date (excluding abnormal usage way and abnormal environments.)



## 7. LCM Dimension

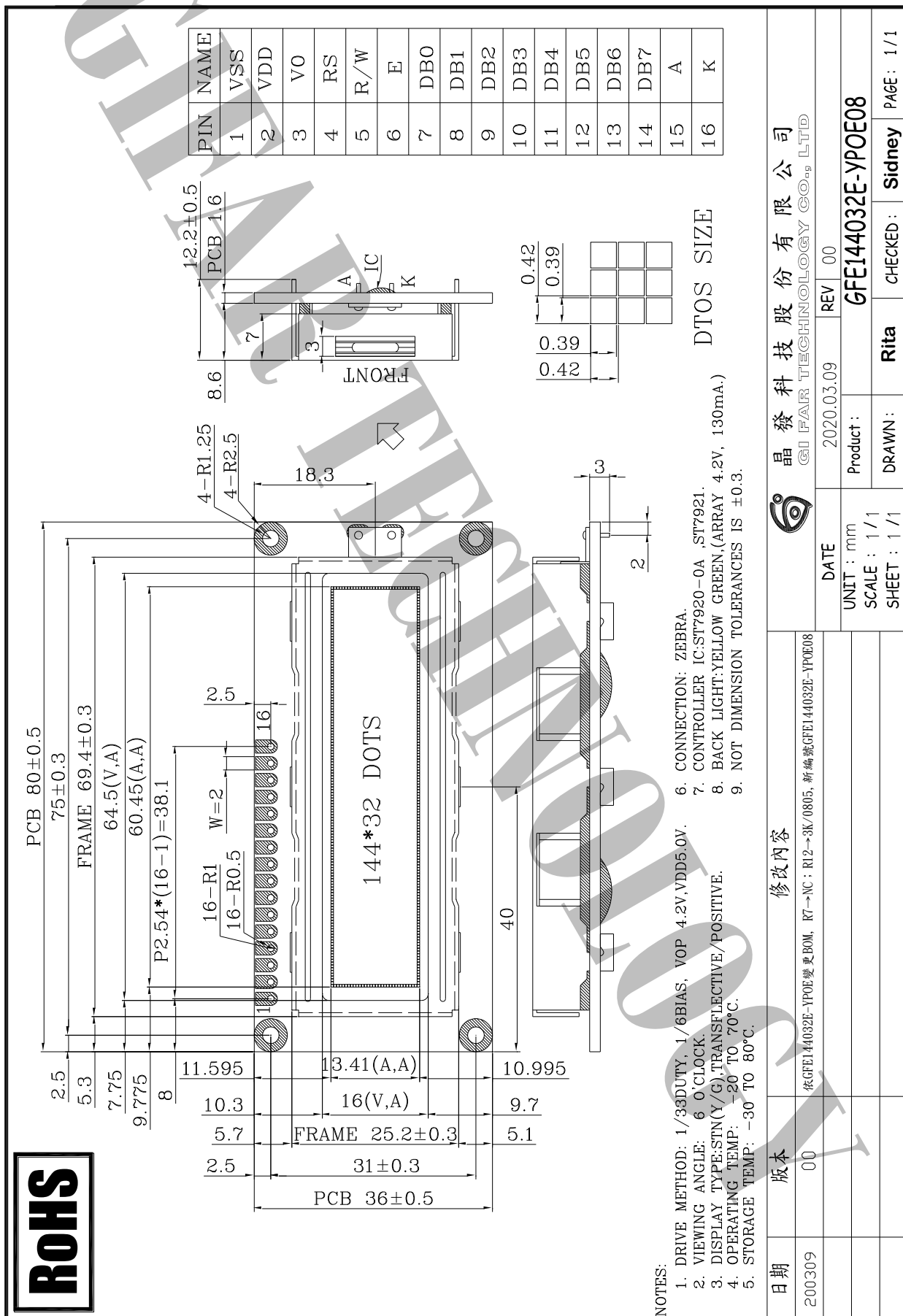

晶發科技股份有限公司  
GI FAR TECHNOLOGY CO., LTD.

日期: 200309  
版本: 00  
修改內容: 依GFE144032E-YPOE變更BOM, R7→NC, R12→3K/0805, 新編號GFE144032E-YPOE08

DATE	2020.03.09	REV	00
UNIT	mm	Product	GFE144032E-YPOE08
SCALE	1 / 1	DRAWN	Rita
SHEET	1 / 1	CHECKED	Sidney
			PAGE: 1 / 1



## 8. Font Code Table

### ST7920-0A

	0	1	2	3	4	5	6	7	8	9	A	B	C	D	E	F
00		☺	☹	♥	♦	♣	♠	●	○	◉	♂	♀	♂	♀	♂	♀
10	▶	◀	↑	!!	¶	§	_	‡	↑	↓	→	←	└	‡	▲	▼
20	!	"	#	\$	%	&	'	(	)	*	+	,	-	.	/	
30	0	1	2	3	4	5	6	7	8	9	:	;	<	=	>	?
40	@	A	B	C	D	E	F	G	H	I	J	K	L	M	N	O
50	P	Q	R	S	T	U	V	W	X	Y	Z	[	\	]	^	_
60	`	a	b	c	d	e	f	g	h	i	j	k	l	m	n	o
70	p	q	r	s	t	u	v	w	x	y	z	{		}	~	△

FOOTPRINT





ST7920-0A

Table with 28 columns (0-F) and 30 rows (A140-A7F0). Each cell contains a symbol or character corresponding to a specific alphanumeric key. The table is organized into two main sections: the first 28 columns and the remaining 2 columns.



晶發科技股份有限公司
GI FAR TECHNOLOGY CO., LTD.

No. 81, Dongfeng St, Shulin District, 238034, New Taipei City, Taiwan, R.O.C.



Grid of Chinese characters organized into 45 rows and 26 columns. Each cell contains a character, often with a small code to its left (e.g., A840, A850, etc.).







晶發科技股份有限公司
GI FAR TECHNOLOGY CO., LTD.

No. 81, Dongfeng St, Shulin District, 238034, New Taipei City, Taiwan, R.O.C.



Table with 26 columns (0-F) and 26 rows (C040-F3F0) containing various Chinese characters and symbols.







## 9. PACKAGE INFORMATION

1	1 Tray	:	20 pcs (modules)
2	1 stack	:	11 tray +1 Cover tray
3	1 Carton	:	(1 Cover tray + 11 tray )x 2 stack
4	Total pcs	:	1 Carton (20pcs*11tray * 2 stack) = 440 pcs
5	Carton size = NO. 17	:	495*315*435mm
6	Net weight	:	12.5 KG
7	Gross weight	:	19.9 KG

\*\* Illustration

- 1 Tray= 20 pcs (modules)



- 1 stack= 11 tray+1 Cover tray



\*\*Each layer of tray should be staggered stacked



- 1 Carton = 2 stack, Total pcs = 440 pcs

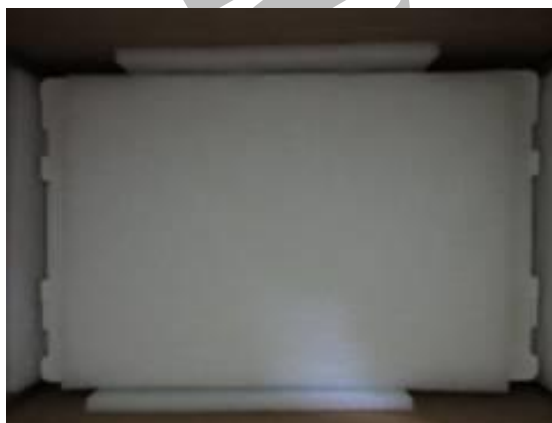



出貨檢驗標準書  
Shipping inspection standard

核准 Approved by	審核 Checked by	作成 Made by
ANDY	JACKY	RUBY

**1.目的 Purpose :**

規範出貨產品之檢驗項目及判斷標準，確保產品出貨能滿足客戶要求。

Standardize the inspection items and judgment standards to ensure the products that shipped out can meet customer's requirements.

**2.範圍 Area :**

適用於出廠之所有產品。

Applicable to all products shipped from the factory.

**3.名詞解釋 Explanation of terms :**

3-1 主要缺陷：亦會造成功能缺失或嚴重外觀缺陷。

Major Defects: It also causes loss of function or serious appearance defects.

3-2 次要缺陷：稍有缺陷但不影響客戶使用。

Minor defect: Slightly defective but does not affect customer use.

**4.檢驗體制 Inspection system :**

4-1 抽樣計劃：依 ANSI/ASQ Z1.4 一般檢驗水準 II 之 正常檢驗一次抽驗方案。

Sampling plan: According to ANSI/ASQ Z1.4 general inspection level II the normal inspection one-time sampling plan.

4-2 允收水準 Acceptable Level : (AQL)

主要缺陷 Major defect : 0.4 %

次要缺陷 Minor defect : 0.65 %

**5.檢驗條件 Inspection conditions :**

5-1 使用相關之檢測儀器及測試、量測工具。

Use relevant testing instrument, testing and measuring tools .

5-2 環境要求：其條件需控制在常溫下  $23^{\circ}\text{C}\pm 3^{\circ}\text{C}$  及溼度 70%RH 以下。

Environmental requirements: The conditions should be controlled at room temperature  $23^{\circ}\text{C}\pm 3^{\circ}\text{C}$  and humidity below 70%RH.

5-3 外觀檢驗：須在  $380\pm 20\%$  LUX 的白色日光燈下，其目視距離需於產品離  $30\pm 5$  cm 檢驗。

Appearance inspection: Under the white fluorescent lamp of  $380\pm 20\%$  LUX , the visual distance shall be checked above the product  $30 \pm 5$  cm.

5-4 電性測試 Electrical Testing :

5-4-1 有背光之產品需關燈並在  $5\sim 300\text{Lux}\pm 3\%$  下檢驗。

The products with backlight should be tested at  $5\sim 300\pm 3\%$  Lux.

5-4-2 無背光之產品需開燈並在  $60\sim 300\text{Lux}\pm 3\%$  白色日光燈下檢驗。

Products without backlight need to be turned on and tested under  $60\sim 300 \pm 3\%$  LUX white fluorescent lamps .

5-5 檢查視角依產品視角方向。

Check the viewing angle according to the product viewing angle.

5-6 其不良現象檢視區域 Bad phenomenon View area

5-6-1 適用種類 Applicable category : COB、TFT

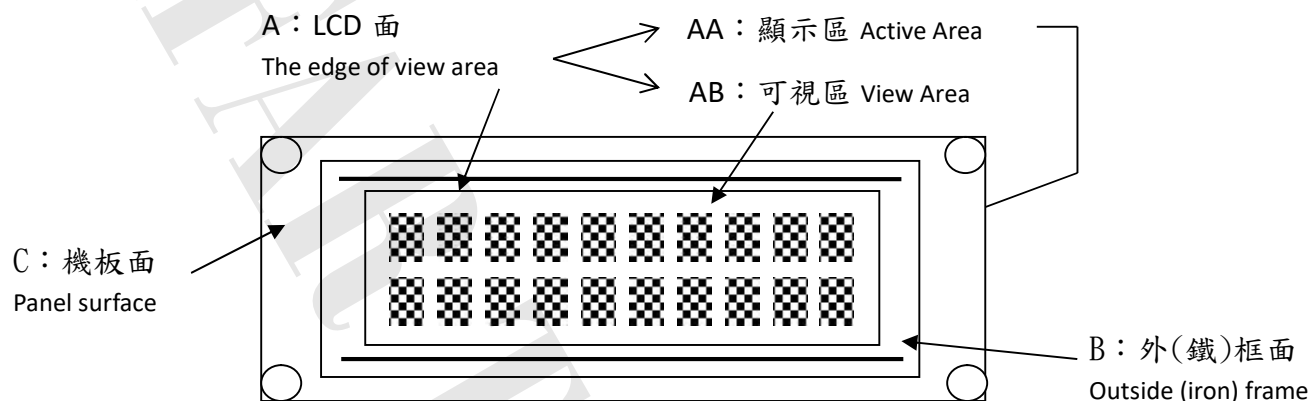

5-6-2 適用種類 Applicable category : COG、TAB、TN

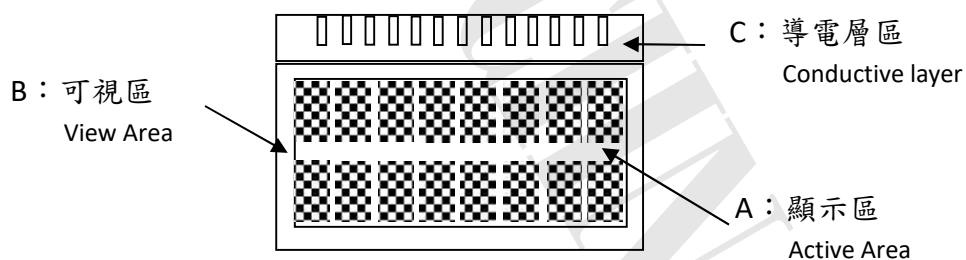

6. 檢驗標準 Inspection standards

COB

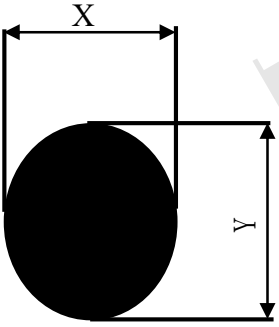
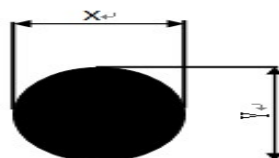
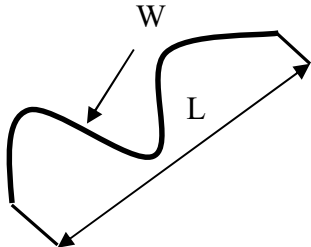
種類 Category		COB																			
編號 No.	檢驗項目 Item	檢驗內容及判定標準 Inspection Content & Standard	區域 Zone	類別 Category	缺陷等級 Level																
1	點類(一) Dot (1)	黑點、刺傷...等圓狀 Black dot、Stab...and other round shape  $\varphi = \frac{(X + Y)}{2}$ 	兩點距離須超過 5 mm Two points have to be $\geq 5$ mm  <table border="1"> <thead> <tr> <th><math>\varphi</math> (mm)</th> <th>允收數 Acceptance Qty</th> </tr> </thead> <tbody> <tr> <td><math>\phi \leq 0.1</math></td> <td>無視 Ignore</td> </tr> <tr> <td><math>0.1 &lt; \phi \leq 0.25</math></td> <td>3</td> </tr> <tr> <td><math>0.25 &lt; \phi \leq 0.3</math></td> <td>1</td> </tr> <tr> <td><math>\phi &gt; 0.3</math></td> <td>0</td> </tr> </tbody> </table>	$\varphi$ (mm)	允收數 Acceptance Qty	$\phi \leq 0.1$	無視 Ignore	$0.1 < \phi \leq 0.25$	3	$0.25 < \phi \leq 0.3$	1	$\phi > 0.3$	0	A	外觀 Appearance	次要 Minor AQL0.65%					
		$\varphi$ (mm)	允收數 Acceptance Qty																		
$\phi \leq 0.1$	無視 Ignore																				
$0.1 < \phi \leq 0.25$	3																				
$0.25 < \phi \leq 0.3$	1																				
$\phi > 0.3$	0																				
其點位於側邊 無視 The dot is located on the side(B area)-OK  <table border="1"> <thead> <tr> <th><math>\varphi</math> (mm)</th> <th>允收數 Acceptance Qty</th> </tr> </thead> <tbody> <tr> <td><math>\phi \leq 0.3</math></td> <td>無視 Ignore</td> </tr> <tr> <td><math>0.3 &lt; \phi \leq 0.5</math></td> <td>3</td> </tr> <tr> <td><math>0.5 &lt; \phi \leq 1</math></td> <td>1</td> </tr> <tr> <td><math>\phi &gt; 1</math></td> <td>0</td> </tr> </tbody> </table>	$\varphi$ (mm)	允收數 Acceptance Qty	$\phi \leq 0.3$	無視 Ignore	$0.3 < \phi \leq 0.5$	3	$0.5 < \phi \leq 1$	1	$\phi > 1$	0	B	外觀 Appearance	次要 Minor AQL0.65%								
$\varphi$ (mm)	允收數 Acceptance Qty																				
$\phi \leq 0.3$	無視 Ignore																				
$0.3 < \phi \leq 0.5$	3																				
$0.5 < \phi \leq 1$	1																				
$\phi > 1$	0																				
2	點類(二) Dot (2)	氣泡、凹凸點 Bubble、Uneven dots  $\varphi = \frac{(X + Y)}{2}$ 	兩點距離須超過 5 mm Two points to be $\geq 5$ mm  <table border="1"> <thead> <tr> <th><math>\varphi</math> (mm)</th> <th>允收數 Acceptance Qty</th> </tr> </thead> <tbody> <tr> <td><math>\phi \leq 0.2</math></td> <td>無視 Ignore</td> </tr> <tr> <td><math>0.2 &lt; \phi \leq 0.5</math></td> <td>2</td> </tr> <tr> <td><math>\phi &gt; 0.5</math></td> <td>0</td> </tr> </tbody> </table>	$\varphi$ (mm)	允收數 Acceptance Qty	$\phi \leq 0.2$	無視 Ignore	$0.2 < \phi \leq 0.5$	2	$\phi > 0.5$	0	A	外觀 Appearance	次要 Minor AQL0.65%							
$\varphi$ (mm)	允收數 Acceptance Qty																				
$\phi \leq 0.2$	無視 Ignore																				
$0.2 < \phi \leq 0.5$	2																				
$\phi > 0.5$	0																				
3	線類 Line	刮傷、毛屑...等線狀 Scratch、Fiber.. and other linear shape.  	<table border="1"> <thead> <tr> <th>L (mm)</th> <th>W (mm)</th> <th>允收數 Acceptance Qty</th> </tr> </thead> <tbody> <tr> <td>--</td> <td><math>W \leq 0.02</math></td> <td>無視 Ignore</td> </tr> <tr> <td><math>L \leq 5</math></td> <td><math>W \leq 0.03</math></td> <td>3</td> </tr> <tr> <td><math>L \leq 3</math></td> <td><math>W \leq 0.05</math></td> <td>2</td> </tr> <tr> <td><math>L &gt; 5</math></td> <td><math>W &gt; 0.05</math></td> <td>0</td> </tr> </tbody> </table>	L (mm)	W (mm)	允收數 Acceptance Qty	--	$W \leq 0.02$	無視 Ignore	$L \leq 5$	$W \leq 0.03$	3	$L \leq 3$	$W \leq 0.05$	2	$L > 5$	$W > 0.05$	0	A	外觀 Appearance	次要 Minor AQL0.65%
L (mm)	W (mm)	允收數 Acceptance Qty																			
--	$W \leq 0.02$	無視 Ignore																			
$L \leq 5$	$W \leq 0.03$	3																			
$L \leq 3$	$W \leq 0.05$	2																			
$L > 5$	$W > 0.05$	0																			
4	底色 Background color	同批供貨不能有明顯色差 No obvious color difference allowed in same shipment. (必要時與客端制定限度樣) (According to the gold samples if necessary)	A	外觀 Appearance	次要 Minor AQL0.65%																

5	零件位置 Parts position	與工程 BOM 上標示不符 拒收 Different with the BOM marked Reject	C	外觀 Appearance	主要 Major AQL 0.4%
6	板面潔淨 FPC/PCB's surface is clean	※ 焊接面上附著錫渣、珠 拒收 Solder side has tin slag, beads or particle Reject ※ 焊接面上附著於過多錫油 拒收 Solder side has too much tin oil Reject	C	外觀 Appearance	次要 Minor AQL0.65%
7	點、線類 (三) Dot、Line (3)	※ 於全黑、白畫面下看見之區塊狀或線狀不良 拒收 There is a block or linear in the view area under the screen is whole black or white. Reject ※ 但依 2% ND Filter 遮蓋無視 允收 But after inspecting by 2% ND Filter without seeing block or linear, it is confirmed Acceptance	AA	電訊 Electronics	次要 Minor AQL0.65%
8	點、線類 (四) Dot、Line (4)	畫面中顯示出現黑、白、亮、異色點或線狀 There is a black, white, bright or other dot or lines showing in the view area. ※ 依編號 1、3 之判定標準 According to the inspection standard: No. 1 and 3.	AA	電訊 Electronics	次要 Minor AQL0.65%
9	缺字 Lack of characters	顯示時畫面缺少部份字元 拒收 Lacking part of characters in the view area. Reject	AA	電訊 Electronics	主要 Major AQL 0.4%
10	無動作 No reaction	顯示畫面一直處於起始畫面而無法進行切換 拒收 The display (view area) always shows in the initial screen and can't be switched to others. Reject	AA	電訊 Electronics	主要 Major AQL 0.4%
11	無畫面 No display	通電後，完全無任何畫面顯示 拒收 After connecting to the power, there is no display. Reject	AA	電訊 Electronics	主要 Major AQL 0.4%
12	斷線 Broken line	顯示畫面中少直、橫線 拒收 There is a lack of vertical or horizontal lines in the view area. Reject	AA	電訊 Electronics	主要 Major AQL 0.4%
13	CROSS TALK	顯示畫面時有局部之條紋或拖影 There are some stripes or shadow/smear showing in the view area. 拒收或與客端簽訂限度樣 Reject or inspect according to the golden sample	AA	電訊 Electronics	次要 Minor AQL0.65%

14	I CON	顯示畫面缺少部份顯示圖案 拒收 Lack of partial ICON in the view area. Reject	AA	電訊 Electronics	主要 Major AQL 0.4%
15	深淺不一 Color difference	顯示畫面的對比，比其他顯示深或淺並依電氣規格(VOP) 值判定 The contrast of display is obviously lighter or darker than others and according to the VOP value in the electronics specification. 拒收或與客端簽訂限度樣 Reject or inspect according to the golden sample	AA	電訊 Electronics	次要 Minor AQL0.65%
16	畫面異常 Abnormal screen	通電後畫面出現未定義之電訊不良現象 拒收 After connecting to the power, there is an undefined electronics appearance showing in the view area. Reject	AA	電訊 Electronics	主要 Major AQL 0.4%
17	背光色不均 Uneven color of backlight	※ 點亮後 LED 有明暗不均現象依其均勻度判定 拒收 After lighting LEDs have brightness and darkness uneven the determined according to its uniformity. Reject ※ 點亮後 LED 色澤不一致 拒收 LED color is inconsistent after lighting Reject	A	電訊 Electronics	次要 Minor AQL0.65%
18	亮度不足 Lack of brightness	波長、色座標、輝度與圖面標示定義不符 拒收 Wave length, chromatic coordinates, brightness don't correspond to the definition of the drawing. Reject	A	電訊 Electronics	次要 Minor AQL0.65%
19	尺寸量測 Size Measurement	未依圖面上標示 拒收 No correspond to the indication on the drawing. Reject	ALL	外觀 Appearance	主要 Major AQL 0.4%
20	其他 Other	如發現有上述未定義之不良則與客端簽訂限度樣 If there is another undefined defective situation. It will be listed as others. The inspection standard is according to the golden sample.	ALL	電訊 Electronics 外觀 Appearance	次要 Minor AQL0.65%