

The following information applies to all G730 Remote I/O Modules

- Application examples
- Connecting to Wired Remote I/O Master modules
- Troubleshooting and alarm list
- Cables
- Precautions

Application Examples

■ G730 COMBINES WITH OMRON'S OTHER REMOTE I/O PRODUCTS

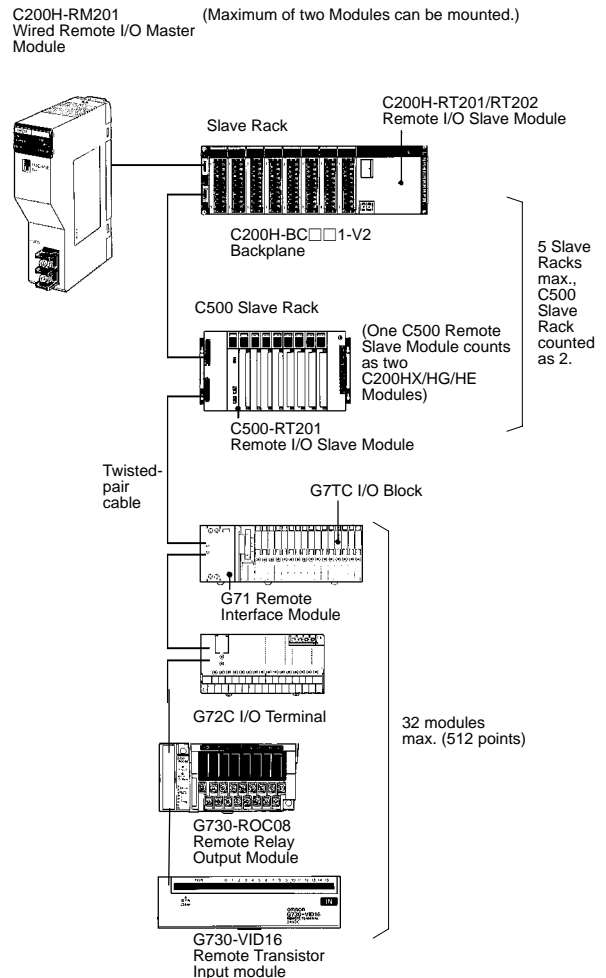
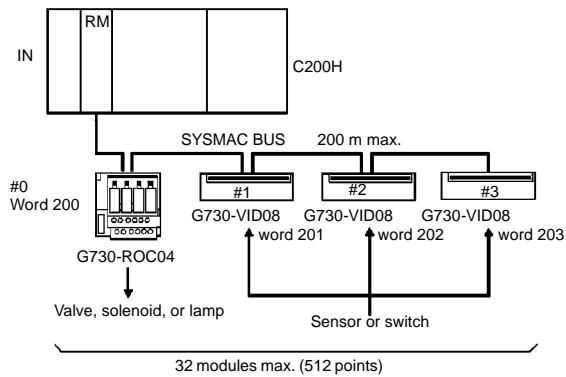

To other Slaves (NT-Series Operator Interface Terminals, G7TC, G70A, G70D I/O Relay Blocks, etc.)

Installation

CONNECTING TO REMOTE I/O MASTER MODULES (WIRED SYSMAC BUS)

The G730-V and G730-R can be connected to a Wired Remote I/O Master. In this case, conventional G71 and G72C models can be used in the same system.

Although the G730-V and the G730-R are 16/8/4-point terminals, each of them occupies one word as an actual allocated word. The G730-ROC04-A (with an error detecting function), however, occupies two words because it must transmit error information to the PLC.

The following tables list the actual word allocations of Remote Terminals on PLCs.

Remote Terminals (other than the G730-ROC04-A)

PLC Model	Actual word allocation
C500	Switch setting word
C1000H/C2000H	(32 words x Remote I/O Master backplane no.) + switch setting word
C200H	200 words + switch setting word

Note: For other PLCs, refer to the operation manuals of those PLCs.

G730-ROC04-A (Two Words are Occupied)

PLC Model	Error information word	Actual word allocation
C500	Switch setting word	Error information word + 1
C1000H/C2000H	(32 words x Remote I/O Master backplane no.) + switch setting word	Error information word + 1
C200H	200 words + switch setting word	Error information word + 1

Note: Refer to *Error Detecting Function* of the G730-ROC04-A.

Example: A C200H PLC is used with the following settings.

- G730-VOD08 set to word 0.
- G730-RIA04 set to word 1.
- G730-ROC04-A (with error detecting function) set to word 2)

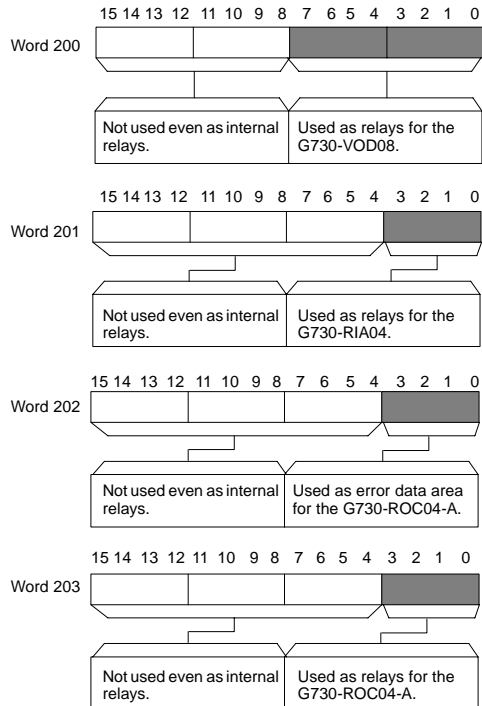

■ TROUBLESHOOTING AND ALARM LIST

	Master Module (Master)					Abnormal Expansion Unit/Slave		Cause of error	Remedy
	PWR	END	T/R	ALM	NODE	PWR	T/R		
Before and after normal operation	Not lit	Not lit	Not lit	Not lit	Not lit	---	---	The G730-M is not turned on.	Turn on the G730-M.
	Lit	Not lit	Not lit	Not lit	Not lit	---	---	CPU abnormality.	Turn off and on the G730-M Master. If the CPU has abnormality again after the G730-M Master is turned on, replace the G730-M Master.
Before normal operation	Lit	Lit	Flashing	---	Lit/Not lit	Lit	Lit	Slaves are set to words 28 to 30.	Slaves must be set to a word range of 0 to 27.
	Lit	Lit	Flashing	---	Not lit	Lit	Lit	No terminator is set.	The terminator switch of the Slave located farthest from the G730-M Master on the transmission path must be set to ON.
								There is more than one G730-M Master in the system.	There must be only one G730-M Master in a single system. If more I/O points are required, connect one to three Expansion Units according to the number of I/O points required.
								A Master Unit different in communication configuration exists.	A different Master Unit in communication configuration cannot be used together with the G730-M/N.
								The transmission path is short-circuited. The transmission path is disconnected. The positive and negative wiring of the transmission path is reversed.	Wire the transmission path correctly.
								The expansion numbers of two Expansion Units with the same I/O configuration are identical.	Assign different words to all Units.
								The words of two Slaves with the same I/O configuration are identical.	
	Lit	Lit	Flashing	---	Not lit	Not lit	Not lit	The terminator has power failure.	Turn on the terminator.
	Lit	Flashing	Flashing	---	Not lit	Lit	Lit	There is more than one terminator.	The terminator switch of only the Slave located farthest from the G730-M Master on the transmission path must be set to ON.
	Lit	Not lit	Flashing	---	Flashing	Lit	Lit	The I/O type of the Master Unit and that of the Slaves do not correspond.	The I/O type of the Master Unit must correspond to the I/O type of the Slaves. Be sure to set them correctly.
								The words of two Slaves different to each other in I/O type are identical.	Set so that no word will be duplicated.
								The expansion numbers of two Expansion Units different to each other in I/O type are identical.	
								Four-point Units are set to words 24 to 27, which is an exclusive area for 8/16-point Units.	
								The word settings for a 8-point/16-point Unit is beyond the specified range.	Not all words between word 00 and word 32 can be used for 8-point or 16-point Units.
								The words for Units with different numbers of points are duplicated.	Assign different words to all Units.
Lit	Not lit	Flashing	---	Not lit	Lit	Lit	A Slave is set to word 31. There is a Slave with no Expansion Unit.	Slaves must be set to words 0 to 27.	
					Not lit	Not lit	The Slaves except the terminator or Expansion Unit in the system are not turned on.	Turn on the Slaves and Expansion Unit.	

	Master Module (Master)					Abnormal Expansion Unit/Slave		Cause of error	Remedy
	PWR	END	T/R	ALM	NODE	PWR	T/R		
After normal operation	Lit	Not lit	Lit	---	---	Lit	Lit	The transmission path is short-circuited. The transmission path is disconnected.	Wire the transmission path correctly.
						Not lit	Not lit	The Expansion Unit is turned off.	Turn on the Expansion Unit.
								The Slave has power failure.	Turn on the Slave.
	Lit	Not lit	Flashing	Lit	Not lit	Lit	Flashing	Relay contact weld, improper relay contact, or load disconnection has caused the Slave to indicate an error detecting function.	Replace the relay or connect the load.
Lit	Not lit	Lit	---	---	Lit	Not lit	The CPU on the Expansion Unit for the Slave has abnormality.	Turn off the Slave and Expansion Unit and turn them on again and check if they operate normally. If they do not operate normally, replace them.	

- Note: 1. Dotted lines mean that the indication of the LEDs have nothing to do with the errors.
 2. Refer to *C-Series Remote I/O Module (Wired-Type) Operation Manual W120* for details on troubleshooting when the system is connected to a Remote I/O Master.

Connector Cables

Use G79 Cables to connect G730 Remote I/O Modules to PLC input and output modules. Complete pinout drawings are in the G79 Cables data sheet in the Wiring Solutions section of this catalog. For controllers from any manufacturer, use G79-Y□C cables with crimp hooks or G79-A□C cables with tinned leads. For dedicated cables used with Omron PLCs, consult the G79 Cables data sheet.

■ G79 CONNECTING CABLE

G79-Y□C with Crimp-style Terminals

Use the G79-Y□C Cable to connect the screw terminals of a controller and the G730-M/N Master Module.

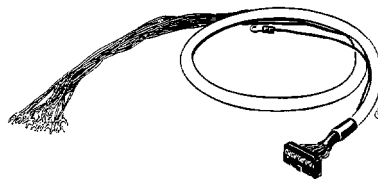

L: Length

1,000 mm	G79-Y100C
1,500 mm	G79-Y150C
2,000 mm	G79-Y200C
3,000 mm	G79-Y300C
5,000 mm	G79-Y500C

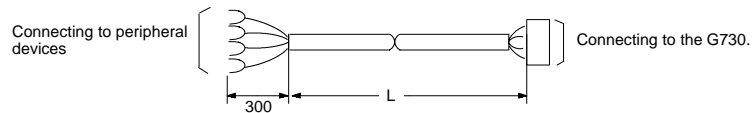

- Note: 1. The wire capacity must be 50 mA max. per I/O.
 2. Each wire has a pin number as shown in the following table *Connections*.

G79-A□C with Multi-strand Cable

The G79-A□C has a multi-strand cable on the controller side.

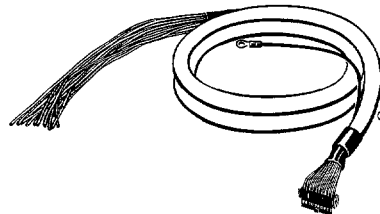

L: Length

2,000 mm	G79-A200C
5,000 mm	G79-A500C

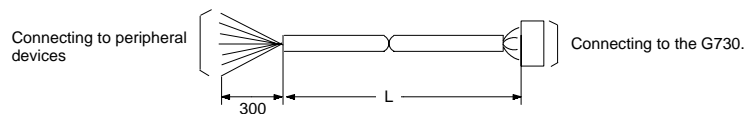

- Note: 1. The diameter of each wire is 0.6 mm (AWG24)
 2. Each wire has a pin number as shown in the following table *Connections*.

Precautions

■ CONNECTION

Wiring

Do not wire the cable near or in parallel with power lines.

Pay attention to the polarities of the terminals.

Be sure to wire the transmission path and power lines correctly.

Design the whole system with the correct voltage specification for I/O exchange.

Installation Site

The following conditions are required to install the G730.

There is no direct sunlight.

The ambient temperature is within a range of 0 to 55 °C.

The relative humidity is within a range of 10% to 90%.

There is no drastic temperature changes that can cause condensation.

There is no corrosive or inflammable gas.

There is no excessive dust, salinity, or powdered metal.

No vibration or shock is directly imposed on the G730.

No water, oil, or chemical is sprayed on the G730.

Protection from Noise

Do not install the G730 on a panel where high-power equipment is installed.

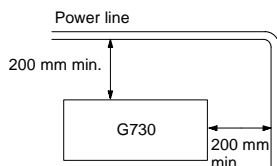

Mounting Screws

Mounting screws must be tightened securely to prevent the G730 from malfunctioning.

Connection Cable Lock

Before turning on the G730, check that the connectors of each connection cable are locked properly.

Static Electricity

Excessive static electricity can be generated where the humidity is low. Before you operate the G730, touch grounded metal so that your body will be free from static electricity.

Cleaning

Use alcohol to clean the G730. Do not use paint thinner; it will dissolve or discolor the paint on the panel of the G730.

Removing Finger Protection Cover

Use a screwdriver to unlock parts (1), (2), and (3).

Provide a distance of 200 mm at least between power lines and the G730.

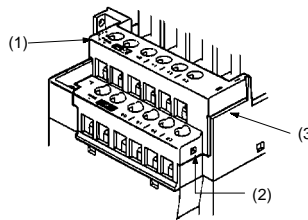

■ MOUNTING ADAPTER

DIN Track Adapter

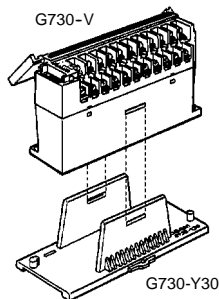

Note: Mount the G730-V to the G730-Y30 so that the G730-V and G730-Y30 mate securely with each other.

NOTE: DIMENSIONS SHOWN ARE IN MILLIMETERS. To convert millimeters to inches divide by 25.4.

OMRON®

OMRON ELECTRONICS, INC.

One East Commerce Drive
Schaumburg, IL 60173

1-800-55-OMRON

OMRON CANADA, INC.

885 Milner Avenue
Scarborough, Ontario M1B 5V8

416-286-6465