

FEATURE

- Operating temperature: -55°C ~ +150°C (Including self-temperature rise)
- Monolithic Inorganic Material Construction
- Closed Magnetic Circuit Avoids Crosstalk
- Noise reduction solution for Signal Line
- Excellent Solderability and Heat Resistance
- AEC-Q200 Compliant



PART NUMBERING SYSTEM



SIM (1) 06 (2) 221 (3) Y (4) A70 (5) M33 (6)

No	item	Code	Description	
(1)	Product Code	SIM	Signal Chip Inductor, Multi-Layer Chip Ferrite Bead Type	
(2)	Dimension	06	06: 1206, 3.20x1.60mm	See Dimensions Table
(3)	Impedance	221	221: 220Ω	First two digit: Significant, Third: Multiplier
(4)	Tolerance	Y	Y: ±25%	-25% ~ +25%
(5)	Rated Current	A70	A70: 0.70A	A: Decimal
(6)	Series Code	M33	Chip Ferrite Bead, AEC-Q200	Internal Control Code

DIMENSIONS

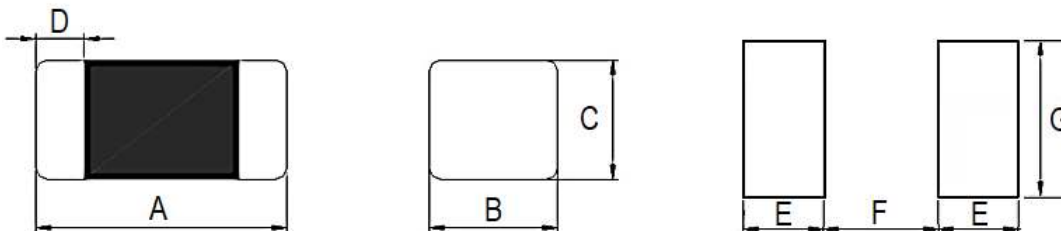

Size Code	A (mm)	B (mm)	C (mm)	D (mm)	E (mm)	F (mm)	G (mm)
SIM02 (0402)	1.00±0.10	0.50±0.10	0.50±0.10	0.25±0.10	0.50	0.40	0.60
SIM03 (0603)	1.6±0.15	0.80±0.15	0.80±0.15	0.30±0.20	0.80	0.85	0.95
SIM05 (0805)	2.00±0.20	1.25±0.20	0.85±0.20	0.50±0.30	1.05	1.00	1.45
SIM06 (1206)	3.20±0.20	1.60±0.20	1.10±0.20	0.50±0.30	1.05	2.20	1.80

ELECTRICAL CHARACTERISTICS

Size	Series	Impedance (Ω)	Tolerance	DCR (Ω) Max.	Rated Current (mA) Max.	Thickness (mm)
1206	SIM06310YA50M33	31	$\pm 25\%$	0.20	500	1.10 \pm 0.20
	SIM06500YA50M33	50	$\pm 25\%$	0.20	500	1.10 \pm 0.20
	SIM06700YA50M33	70	$\pm 25\%$	0.20	500	1.10 \pm 0.20
	SIM06121YA90M33	120	$\pm 25\%$	0.15	900	1.10 \pm 0.20
	SIM06301YA70M33	300	$\pm 25\%$	0.35	700	1.10 \pm 0.20
	SIM06601YA40M33	600	$\pm 25\%$	0.40	400	1.10 \pm 0.20

Notes: 1. Test Frequency: 100MHz; 2. Rated Current based on Temperature Rise Test

CHARACTERISTIC CURVES

SIM06310YA50M33

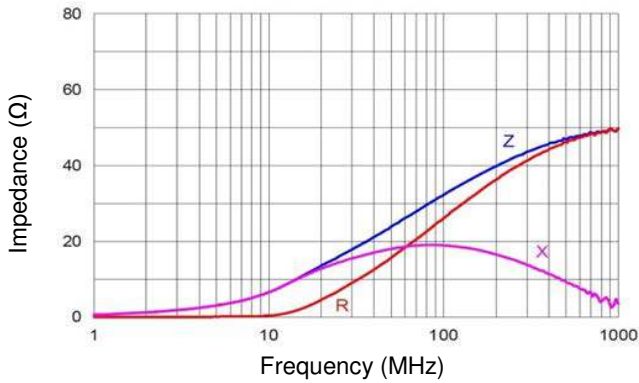

SIM06500YA50M33

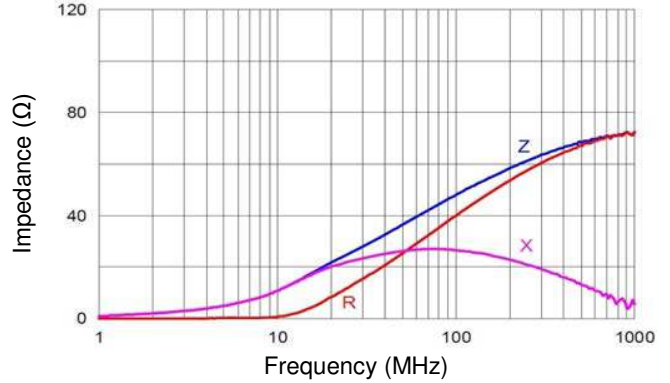

SIM06700YA50M33

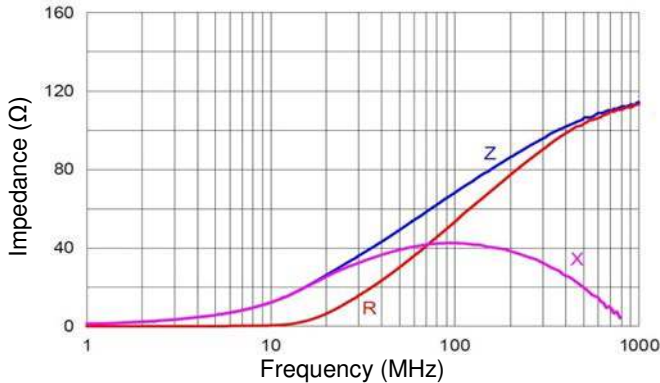

SIM06121YA90M33

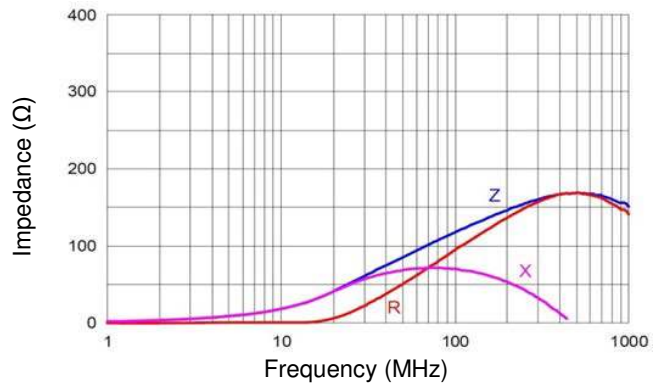

SIM06301YA70M33

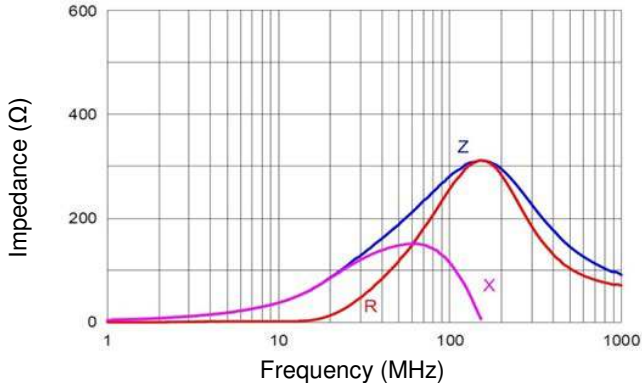

SIM06601YA40M33

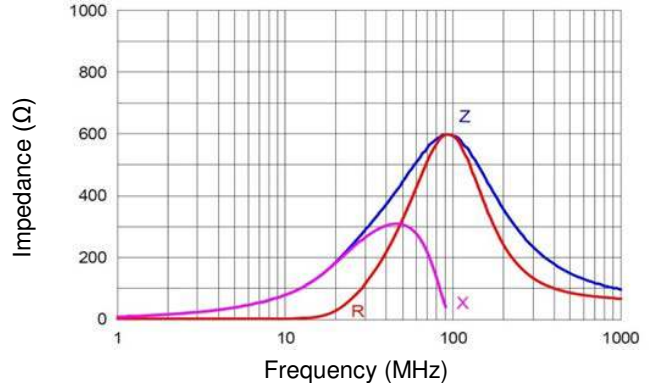

RELIABILITY TEST CONDITON AND REQUIREMENT

Item	Test Conditions	Requirement															
Temperature Rise Test	Applied the allowed DC current. Temperature measured by digital surface thermometer.	Rated Current < 1A ΔT 20°CMax. Rated Current \geq 1A ΔT 40°CMax.															
High Temperature Exposure (Storage)	Preconditioning: Run through IR reflow for 3 times. Temperature: 150 \pm 2°C Duration: 1000hrs Min. Measured at room temperature after 24 \pm 2 Hrs.	Appearance: no damage. Impedance: within \pm 15%of initial value. Inductance: within \pm 10%of initial value. Q: shall not exceed the specification value. RDC: within \pm 15% of initial value and shall not exceed the specification value.															
Temperature Cycling	Preconditioning: Run through IR reflow for 3 times. Number of cycles: 1000. Condition for 1 cycle: <table border="1" data-bbox="334 701 982 854"> <thead> <tr> <th>No.</th> <th>Temp. (°C)</th> <th>Time (min.)</th> </tr> </thead> <tbody> <tr> <td>1</td> <td>-55\pm2°C</td> <td>30 Min.</td> </tr> <tr> <td>2</td> <td>+150\pm2°C Transition time</td> <td>1 Max.</td> </tr> <tr> <td>3</td> <td>+150\pm2°C</td> <td>30 Min.</td> </tr> <tr> <td>4</td> <td>Low Temperature Transition time</td> <td>1 Max.</td> </tr> </tbody> </table> Measured at room temperature after placing for 24 \pm 2 hrs.	No.	Temp. (°C)	Time (min.)	1	-55 \pm 2°C	30 Min.	2	+150 \pm 2°C Transition time	1 Max.	3	+150 \pm 2°C	30 Min.	4	Low Temperature Transition time	1 Max.	Appearance: no damage. Impedance: within \pm 15%of initial value. Inductance: within \pm 10%of initial value. Q: shall not exceed the specification value. RDC: within \pm 15% of initial value and shall not exceed the specification value.
No.	Temp. (°C)	Time (min.)															
1	-55 \pm 2°C	30 Min.															
2	+150 \pm 2°C Transition time	1 Max.															
3	+150 \pm 2°C	30 Min.															
4	Low Temperature Transition time	1 Max.															
Biased Humidity (AEC-Q200)	Preconditioning: Run through IR reflow for 3 times. Humidity: 85 \pm 3%R.H. Temperature: 85 \pm 2°C. Duration: 1000hrs Min. with 100% rated current. Measured at room temperature after 24 \pm 2 hrs.	Appearance: no damage. Impedance: within \pm 15%of initial value. Inductance: within \pm 10%of initial value. Q: shall not exceed the specification value. RDC: within \pm 15% of initial value and shall not exceed the specification value.															
High Temperature Operational Life	Preconditioning: Run through IR reflow for 3 times. Temperature: 150 \pm 2°C Duration: 1000hrs Min. with 100% rated current. Measured at room temperature after 24 \pm 2 Hrs.	Appearance: no damage. Impedance: within \pm 15%of initial value. Inductance: within \pm 10%of initial value. Q: shall not exceed the specification value. RDC: within \pm 15% of initial value and shall not exceed the specification value.															
External Visual	Inspect device construction, marking and workmanship. Electrical test not required	Appearance: no damage.															
Physical Dimension	According to the product specification size measurement	According to the product specification size measurement															
Resistance to Solvents	Add aqueous wash chemical – OKEM clean or equivalent	Appearance: no damage.															
Mechanical Shock	Preconditioning: Run through IR reflow for 2 times. Test condition: <table border="1" data-bbox="329 1640 987 1782"> <thead> <tr> <th>Type</th> <th>Peak Value (g's)</th> <th>Normal duration (ms)</th> <th>Wave Form</th> <th>Velocity change (ft/sec)</th> </tr> </thead> <tbody> <tr> <td>SMD</td> <td>100</td> <td>6</td> <td>Half-sine</td> <td>12.3</td> </tr> <tr> <td>Lead</td> <td>100</td> <td>6</td> <td>Half-sine</td> <td>12.3</td> </tr> </tbody> </table> 3 shocks in each direction along 3 perpendicular axes.	Type	Peak Value (g's)	Normal duration (ms)	Wave Form	Velocity change (ft/sec)	SMD	100	6	Half-sine	12.3	Lead	100	6	Half-sine	12.3	Appearance: no damage. Impedance: within \pm 15%of initial value. Inductance: within \pm 10%of initial value. Q: shall not exceed the specification value. RDC: within \pm 15% of initial value and shall not exceed the specification value.
Type	Peak Value (g's)	Normal duration (ms)	Wave Form	Velocity change (ft/sec)													
SMD	100	6	Half-sine	12.3													
Lead	100	6	Half-sine	12.3													

RELIABILITY TEST CONDITON AND REQUIREMENT

Item	Test Conditions	Requirement												
Vibration	Preconditioning: Run through IR reflow for 3 times. Oscillation Frequency: 10~2K~10 Hz for 20 minutes Equipment: Vibration checker Total Amplitude:10g Testing Time: 12 hours (20 minutes, 12 cycles each of 3 orientations)	Appearance: no damage. Impedance: within±15%of initial value. Inductance: within±10%of initial value. Q: Shall not exceed the specification value RDC: within ±15% of initial value and shall not exceed the specification value.												
Resistance to Soldering Heat	Test Condition: MIL-STD-202 Condition B Number of heat cycles: 1, Depth: Completely cover the termination Temperature: 260±5°C for 10 sec. Temperature ramp/immersion and emersion rate 25mm/s ±6 mm/s.	Appearance: no damage. Impedance: within±15%of initial value. Inductance: within±10%of initial value. Q: Shall not exceed the specification value RDC: within ±15% of initial value and shall not exceed the specification value.												
Thermal Shock	Preconditioning: Run through IR reflow for 3 times. Number of cycles: 300. Condition for 1 cycle: <table border="1" data-bbox="334 831 982 951"> <thead> <tr> <th>No.</th> <th>Temp. (°C)</th> <th>Time (min.)</th> </tr> </thead> <tbody> <tr> <td>1</td> <td>-55±2°C</td> <td>15±1</td> </tr> <tr> <td>2</td> <td>+150±2°C</td> <td>within 20 sec.</td> </tr> <tr> <td>3</td> <td>+150±2°C</td> <td>15±1</td> </tr> </tbody> </table> Measured at room temperature after placing for 24±2 hrs.	No.	Temp. (°C)	Time (min.)	1	-55±2°C	15±1	2	+150±2°C	within 20 sec.	3	+150±2°C	15±1	Appearance: no damage. Impedance: within±15%of initial value. Inductance: within±10%of initial value. Q: shall not exceed the specification value. RDC: within ±15% of initial value and shall not exceed the specification value.
No.	Temp. (°C)	Time (min.)												
1	-55±2°C	15±1												
2	+150±2°C	within 20 sec.												
3	+150±2°C	15±1												
ESD	Direct contact discharge 4KV (Level 2)	Appearance: no damage.												
Solderability	Method B, 4hrs at 155°C, dry heat at 235°C±5°C, Test time: 5 +0/-0.5 sec. Method D category 3. (Steam aging 8 hrs ±15min) at 260°C±5°C, Test time: 30 +0/-0.5 sec.	More than 95% of the terminal electrode should be covered with solder.												
Flammability	V-0 or V-1 are acceptable	Electrical test not required.												
Bending	Shall be mounted on a FR4 substrate of the following dimensions: <table border="1" data-bbox="334 1394 982 1455"> <thead> <tr> <th>Dimensions</th> <th>Bending depth</th> </tr> </thead> <tbody> <tr> <td>40x100x1.6mm</td> <td>2.0mm (min).</td> </tr> </tbody> </table> Duration of applied force 60+5 sec. The force is to be applied only once to the board	Dimensions	Bending depth	40x100x1.6mm	2.0mm (min).	Appearance: no damage.								
Dimensions	Bending depth													
40x100x1.6mm	2.0mm (min).													
Terminal strength	Preconditioning: Run through IR reflow for 2 times. With component mounted on a PCB apply a force of 17.7(N) (1.8Kg) force to the side of a device being tested. This force shall be applied for 60 +1 seconds. Also, the force shall be applied gradually as not to shock the component being tested.	Appearance: no damage.												

RECOMMENDED SOLDERING PROFILES

Reflow Condition		
Pre Heat	Temp. Min $T_{s(min)}$	150°C
	Temp. Max $T_{s(max)}$	200°C
	Time (min. to max.) (t_s)	60 ~120 seconds
Reflow	Temp. (T_L)	217°C
	Time (min. to max.) (t_L)	60 ~150 seconds
Peak Temperature (T_P)		260°C
Time within 5°C of actual peak Temperature (t_p)		< 30 seconds
Reflow times:		3 times Max.

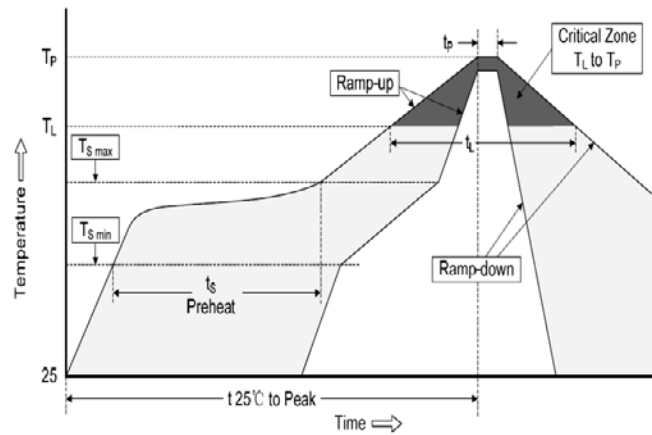

DERATING CURVE

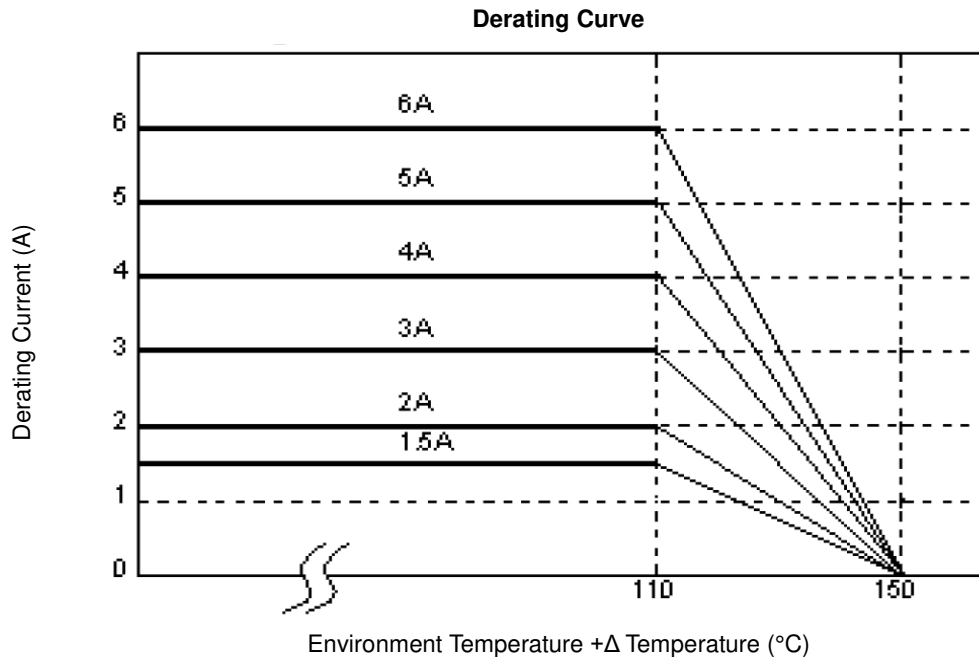

PACKAGING SPECIFICATIONS

Reel Specification & Packaging Quantity

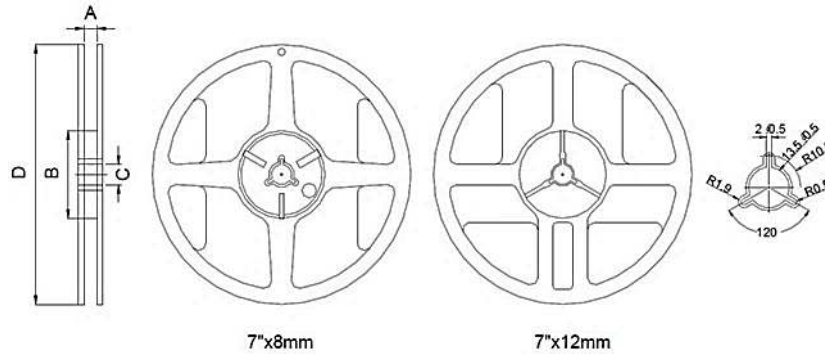

Size	Reel Dimension (mm)						
	Quantity	Tape Width	Reel Diameter	A	B	C	D
0402	Paper 10K	8mm	7"	9.0±0.5	60.0±2.0	13.5±0.5	178.0±2.0
0603	Paper 4K	8mm	7"	9.0±0.5	60.0±2.0	13.5±0.5	178.0±2.0
0805	Paper 4K	8mm	7"	9.0±0.5	60.0±2.0	13.5±0.5	178.0±2.0
1206	Plastic 3K	8mm	7"	9.0±0.5	60.0±2.0	13.5±0.5	178.0±2.0

PACKAGING SPECIFICATIONS

Paper Tape Specification

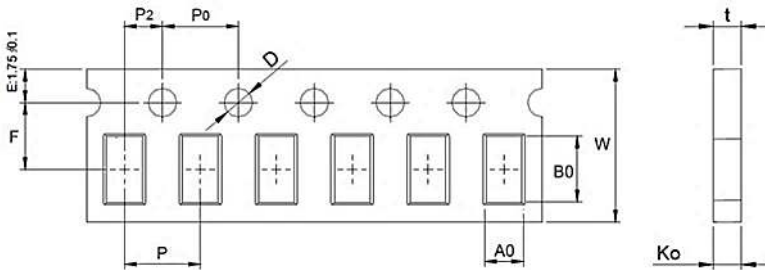

Plastic Tape Specification

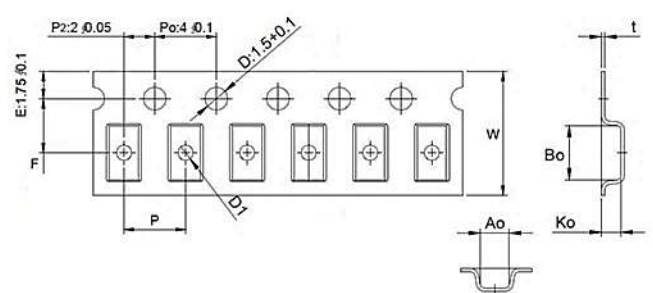

Size	Paper Tape Dimension (mm)									
	A0	B0	W	F	P ₀	P	P ₂	D	t	Ko
0402	0.62±0.03	1.12±0.03	8±0.3	3.5±0.05	4±0.1	2±0.05	-	1.5±0.1	0.6±0.03	0.6±0.03
0603	0.96+0.05/-0.03	1.80±0.05	8±0.1	3.5±0.1	4±0.1	4±0.1	2±0.1	1.56+0.1/-0.05	0.95±0.05	0.95±0.05
0805	1.3±0.05	2.1±0.05	8±0.1	3.5±0.1	4±0.1	4±0.1	2±0.1	1.56+0.1/-0.05	0.95±0.05	0.95±0.05
Size	Plastic Tape Dimension (mm)									
	A0	B0	W	F	P	P ₀	P ₂	D1	t	Ko
1206	1.75±0.1	3.35±0.1	8±0.1	3.5±0.05	4±0.1	4±0.1	2±0.05	1±0.1	0.23±0.05	1.25±0.1

*Specifications subject to change without notice.