



- Double-aperture transformer for VHF/UHF receivers/transmitters and push-pull amplifiers
- 260°C Reflow compatible
- Operating Temp Range: -40°C to +85°C
- Storage Temp Range: -45°C to +105°C



Electrical Specifications @25°C						
Inductance (μH)		Inductance Tolerance	Test Frequency KHz, 0.3V	DCR (mΩ) Max		Turns Ratio
1 - 4	2 - 3			1 - 4	2 - 3	
20.0	20.0	±30%	10	23	23	(1-4) : (2-3) 1 : 1

All specifications subject to change without notice.

MECHANICAL

Dimensions: $\frac{\text{inch}}{\text{(mm)}}$

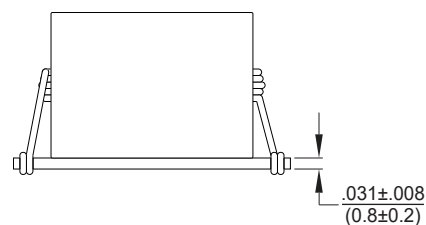
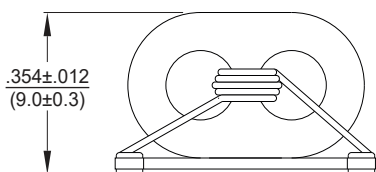
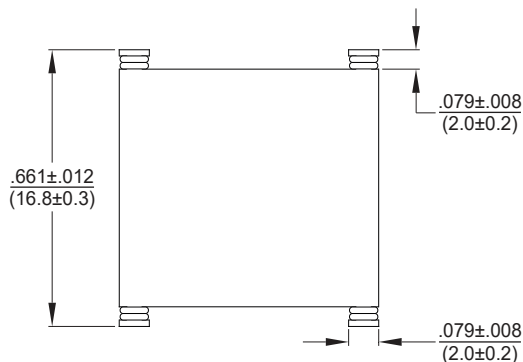
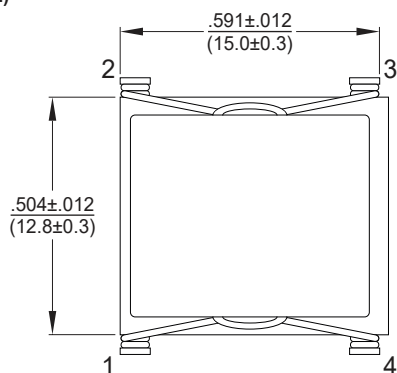

SCHEMATIC

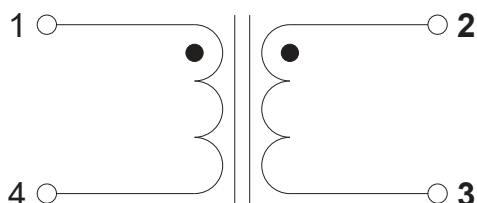

PCB LAYOUT

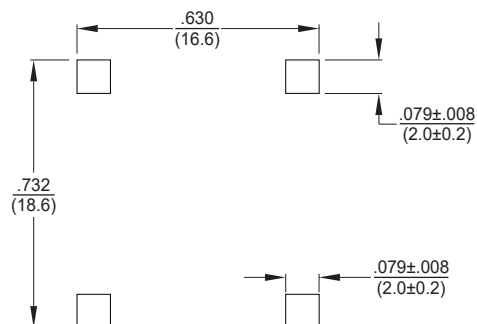



RECOMMENDED SOLDER PROFILE

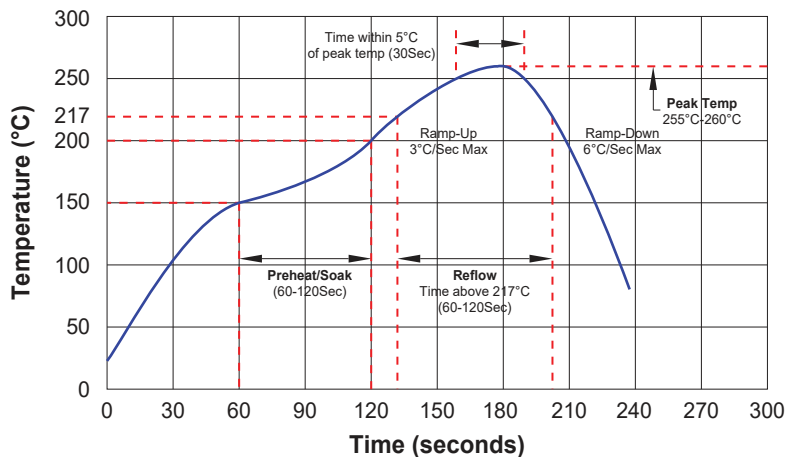

PACKAGING INFORMATION

Dimensions: mm

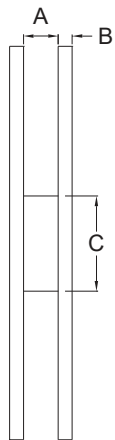
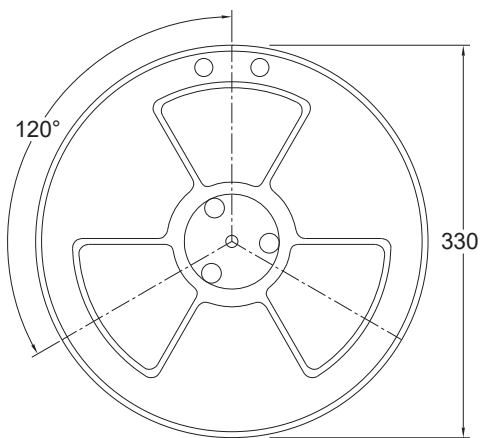

OD	A	B	C
330	32.5±0.1	2.3±0.1	100±0.1

*250 pcs per Reel

