

ATV12PU30M3

variable speed drive ATV12 - 3kW - 3 hp - 3ph
- 200..240V - on base plate



Main

Product destination	Asynchronous motors
Component name	ATV12
Built-in fan	Without
Phase	3 phase
Motor power kW	3 kW
Line current	19 A 200 V 15.9 A 240 V
Speed range	1...20
IP degree of protection	IP20 without blanking plate on upper part
Range of Product	Altivar 12
Product or Component Type	Variable speed drive
Product Specific Application	Simple machine
Communication Port Protocol	Modbus
[Us] rated supply voltage	200...240 V - 15...10 %
EMC filter	Without EMC filter

Complementary

Supply frequency	50/60 Hz +/- 5 %
Connector type	1 RJ45 on front face)Modbus
Physical interface	2-wire RS 485 Modbus
Transmission frame	RTU Modbus
Transmission rate	4800 bit/s 9600 bit/s 19200 bit/s 38400 bit/s
Number of addresses	1...247 Modbus
Communication service	Read holding registers (03) 29 words Write single register (06) 29 words Write multiple registers (16) 27 words Read/Write multiple registers (23) 4/4 words Read device identification (43)
Continuous output current	12.2 A 4 kHz
Maximum transient current	18.3 A 60 s
Speed drive output frequency	0.5...400 Hz
Braking torque	Up to 70 % of nominal motor torque without braking resistor
Output voltage	200...240 V 3 phase
Electrical connection	Terminal 5.5 mm ² , AWG 10 L1, L2, L3, U, V, W, PA, PC)
Tightening torque	10.62 lbf.in (1.2 N.m)
Insulation	Electrical between power and control
Supply	Internal supply for reference potentiometer 5 V DC 4.75...5.25 V), <10 mA overload and short-circuit protection Internal supply for logic inputs 24 V DC 20.4...28.8 V), <100 mA overload and short-circuit protection
Analogue input type	Configurable current AI1 0...20 mA 250 Ohm Configurable voltage AI1 0...10 V 30 kOhm Configurable voltage AI1 0...5 V 30 kOhm
Discrete input type	Programmable LI1...LI4 24 V 18...30 V

The information provided in this documentation contains general descriptions and/or technical characteristics of the performance of the products contained herein. This documentation is not intended as a substitute for and is not to be used for determining suitability or reliability of these products for specific user applications. It is the duty of any such user or integrator to perform the appropriate and complete risk analysis, evaluation and testing of the products with respect to the relevant specific application or use thereof. Neither Schneider Electric Industries SAS nor any of its affiliates or subsidiaries shall be responsible or liable for misuse of the information contained herein.

Discrete input logic	Negative logic (sink), > 16 V, < 10 V 3.5 kOhm Positive logic (source), 0...< 5 V, > 11 V
Sampling duration	20 Ms +/- 1 ms logic input 10 ms analogue input
Linearity error	+/- 0.3 % of maximum value analogue input
Analogue output type	AO1 software-configurable voltage 0...10 V 470 Ohm 8 bits AO1 software-configurable current 0...20 mA 800 Ohm 8 bits
Discrete output type	Logic output LO+, LO- Protected relay output R1A, R1B, R1C 1 C/O
Minimum switching current	5 mA 24 V DC logic relay
Maximum switching current	2 A 250 V AC inductive cos phi = 0.4 L/R = 7 ms logic relay 2 A 30 V DC inductive cos phi = 0.4 L/R = 7 ms logic relay 3 A 250 V AC resistive cos phi = 1 L/R = 0 ms logic relay 4 A 30 V DC resistive cos phi = 1 L/R = 0 ms logic relay
Braking to standstill	By DC injection, <30 s
Frequency resolution	Analog input converter A/D, 10 bits Display unit 0.1 Hz
Time constant	20 ms +/- 1 ms for reference change
Variable speed drive application selection	Commercial equipment Mixer Commercial equipment Other application Textile Ironing
Motor starter type	Variable speed drive
Discrete input number	4
Discrete output number	2
Analogue input number	1
Analogue output number	1
Asynchronous motor control profile	Sensorless flux vector control Voltage/Frequency ratio (V/f) Quadratic voltage/frequency ratio
Transient overtorque	150...170 % of nominal motor torque depending on drive rating and type of motor
Acceleration and deceleration ramps	S U Linear from 0 to 999.9 s
Motor slip compensation	Preset in factory Adjustable
Switching frequency	2...16 kHz adjustable 4...16 kHz with derating factor
Nominal switching frequency	4 kHz
Prospective line I _{sc}	5 kA
Protection type	Line supply overvoltage Line supply undervoltage Overcurrent between output phases and earth Overheating protection Short-circuit between motor phases Against input phase loss in three-phase Thermal motor protection via the drive by continuous calculation of I ² t
Quantity per Set	Set of 1
Width	5.51 in (140 mm)
Height	7.24 in (184 mm)
Depth	3.94 in (100.2 mm)
Net Weight	3.53 lb(US) (1.6 kg)

Environment

Electromagnetic emission	Radiated emissions environment 1 category C2 EN/IEC 61800-3 2...16 kHz shielded motor cable Conducted emissions EN/IEC 61800-3
Vibration resistance	1 gn 13...200 Hz)EN/IEC 60068-2-6 1.5 mm peak to peak 3...13 Hz) - drive unmounted on symmetrical DIN rail - EN/IEC 60068-2-6
Shock resistance	15 gn 11 ms EN/IEC 60068-2-27
Relative humidity	5...95 % without condensation IEC 60068-2-3 5...95 % without dripping water IEC 60068-2-3
Ambient air temperature for operation	14...104 °F (-10...40 °C) protective cover from the top of the drive removed 104...140 °F (40...60 °C) with current derating 2.2 % per °C

Operating altitude	<= 3280.84 ft (1000 m) without derating > 3280.84...9842.52 ft (> 1000...3000 m) with current derating 1 % per 100 m
Operating position	Vertical +/- 10 degree
Product Certifications	CSA GOST UL C-tick NOM
Marking	CE
Assembly style	On base plate
Electromagnetic compatibility	Electrical fast transient/burst immunity test level 4 EN/IEC 61000-4-4 Electrostatic discharge immunity test level 3 EN/IEC 61000-4-2 Immunity to conducted disturbances level 3 EN/IEC 61000-4-6 Radiated radio-frequency electromagnetic field immunity test level 3 EN/IEC 61000-4-3 Surge immunity test level 3 EN/IEC 61000-4-5 Voltage dips and interruptions immunity test EN/IEC 61000-4-11
Noise level	0 dB
Ambient Air Temperature for Storage	-13...158 °F (-25...70 °C)





Ordering and shipping details

Category	22042 - ATV12 DRIVE AND ACCESSORIES
Discount Schedule	CP4B
GTIN	3606480071256
Nbr. of units in pkg.	1
Package weight(Lbs)	4.85 lb(US) (2.2 kg)
Returnability	No
Country of origin	ID

Packing Units

Unit Type of Package 1	PCE
Package 1 Height	9.76 in (24.8 cm)
Package 1 width	7.68 in (19.5 cm)
Package 1 Length	10.51 in (26.7 cm)
Unit Type of Package 2	P06
Number of Units in Package 2	12
Package 2 Weight	86.86 lb(US) (39.4 kg)
Package 2 Height	28.94 in (73.5 cm)
Package 2 width	23.62 in (60 cm)
Package 2 Length	31.50 in (80 cm)

Offer Sustainability

California proposition 65	WARNING: This product can expose you to chemicals including: Lead and lead compounds, which is known to the State of California to cause cancer and birth defects or other reproductive harm. For more information go to www.P65Warnings.ca.gov
REACH Regulation	 REACH Declaration
EU RoHS Directive	Pro-active compliance (Product out of EU RoHS legal scope)  EU RoHS Declaration
Mercury free	Yes
RoHS exemption information	 Yes
China RoHS Regulation	 China RoHS Declaration
WEEE	The product must be disposed on European Union markets following specific waste collection and never end up in rubbish bins.

Contractual warranty

Warranty	18 months
----------	-----------

Dimensions

Drive without EMC Conformity Kit

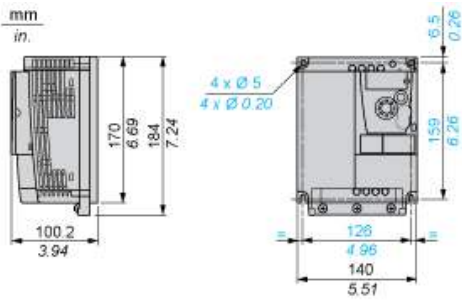

Drive with EMC Conformity Kit

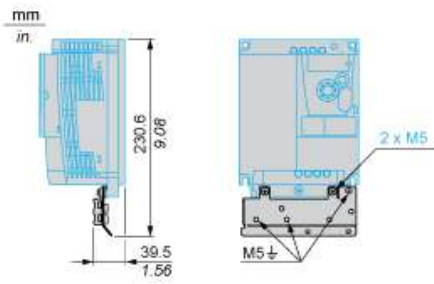

Mounting Recommendations

Clearance for Vertical Mounting

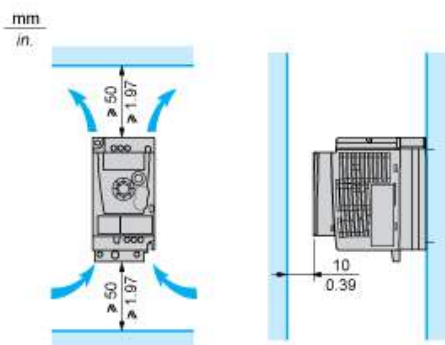

Mounting Type A

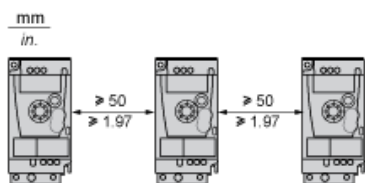

Mounting Type B

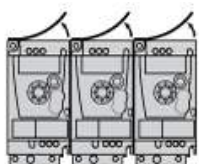

Remove the protective cover from the top of the drive.

Mounting Type C

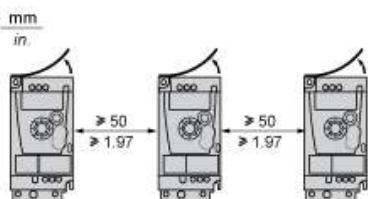

Remove the protective cover from the top of the drive.

Three-Phase Power Supply Wiring Diagram

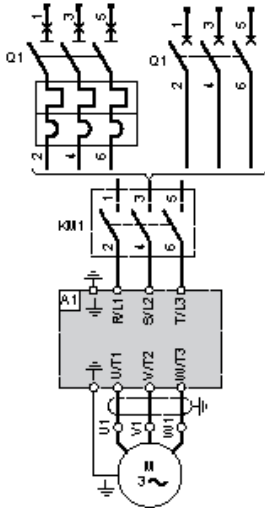

- A1 Drive
- KM1 Contactor (only if a control circuit is needed)
- Q1 Circuit breaker

Recommended Schemes

2-Wire Control for Logic I/O with Internal Power Supply

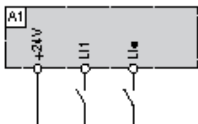

- L1 : Forward
- L1• : Reverse
- A1 : Drive

3-Wire Control for Logic I/O with Internal Power Supply

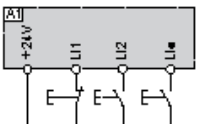

- L1 : Stop
- L2 : Forward
- L1• : Reverse
- A1 : Drive

Analog Input Configured for Voltage with Internal Power Supply

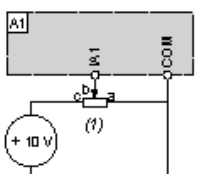

- (1) 2.2 kΩ...10 kΩ reference potentiometer
- A1 : Drive

Analog Input Configured for Current with Internal Power Supply



(2) 0-20 mA 4-20 mA supply
 A1 : Drive

Connected as Positive Logic (Source) with External 24 vdc Supply

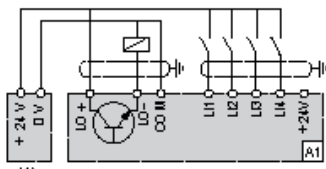

(1) 24 vdc supply
 A1 : Drive

Connected as Negative Logic (Sink) with External 24 vdc supply

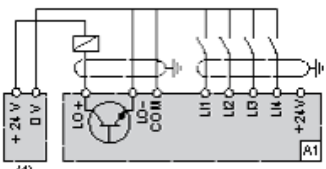

(1) 24 vdc supply
 A1 : Drive

Torque Curves



- 1 : Self-cooled motor: continuous useful torque (1)
 - 2 : Force-cooled motor: continuous useful torque
 - 3 : Transient overtorque for 60 s
 - 4 : Transient overtorque for 2 s
 - 5 : Torque in overspeed at constant power (2)
- (1) For power ratings ≤ 250 W, derating is 20% instead of 50% at very low frequencies.
(2) The nominal motor frequency and the maximum output frequency can be adjusted from 0.5 to 400 Hz. The mechanical overspeed capability of the selected motor must be checked with the manufacturer.