

# 3-phase + neutral line filters FN 256

## Compact general purpose three-phase and neutral line EMC filter

**SCHAFFNER**  
energy efficiency and reliability



- Three-phase and neutral line filter for general purpose four-wire filtering
- Compact space-saving design
- Choice of connection style
- Low operating leakage current

### Approvals



### Technical specifications

Maximum continuous operating voltage:	3x 480/277VAC
Operating frequency:	dc to 60Hz
Rated currents:	8 to 160A @ 50°C
High potential test voltage:	P → E 2650VDC for 2 sec P → P 2100VDC for 2 sec
Protection category:	IP20
Overload capability:	IP00 (filters with connectors -28) 4x rated current at switch on, 1.5x rated current for 1 minute, once per hour
Temperature range (operation and storage):	-25°C to +100°C (25/100/21)
Flammability corresponding to:	UL 94V-2 or better
Design corresponding to:	UL 1283, CSA 22.2 No. 8 1986, IEC/EN 60939
MTBF @ 50°C/400V (Mil-HB-217F):	600,000 hours

### Typical electrical schematic

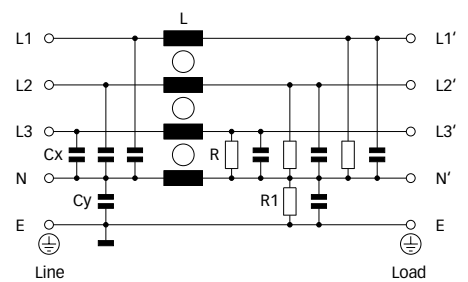



### Features and benefits

- FN 256 filters are designed specifically for applications involving asymmetric loads, ranging from industrial controls to medical electronics systems. These typically involve insufficiently filtered converters and switch-mode power supplies on different phases, causing current imbalance and significant interference problems.
- Employing single-stage filter circuits for each phase and the neutral line, FN 256 filters provide high attenuation of both symmetrical and asymmetrical interference.
- Used as a mains input filter, FN 256 filters also increase conducted immunity and thus contribute to overall system reliability.
- Choice of connection style as well as filter ratings in line with common fuse values support a fast and easy application-specific filter selection and deployment.
- A light weight aluminium housing with a small footprint ensures that the filters can be easily accommodated on control panels and in tight power cabinets.

### Typical applications

- General purpose four-wire filtering
- High-power office equipment
- Power supplies
- UPS
- Medical applications
- Electrical cabinets
- Control panels

Filter selection table

Filter*	Rated current @ 50°C (40°C)	Leakage current** @ 400VAC/50Hz	Power loss @ 25°C/50Hz	Input/Output connections		Weight
	[A]	[mA]	[W]			[kg]
FN 256-8-46	8 (8.8)	3.4	2.7	-46		0.8
FN 256-16-46	16 (17.5)	3.4	6.0	-46		1.1
FN 256-25-47	25 (27)	3.4	11.6	-47		1.4
FN 256-36-47	36 (39)	3.4	14.8	-47		1.5
FN 256-64-52	64 (70)	3.4	18.4	-52		2.2
FN 256-80-..	80 (88)	3.4	18.8		-28***	4.5
FN 256-120-..	120 (131)	5.0	25.1		-28***	6.1
FN 256-160-..	160 (175)	6.8	30.7		-28***	8.0

\* To compile a complete part number, please replace the -.. with the required I/O connection style.

\*\* Maximum leakage under normal operating conditions, based on the assumption that all three phases and the neutral conductor are connected to the supply and the consumer. In this case, the current will mainly return through the neutral line, not as earth leakage.

\*\*\* Filters with -28 connections are rated for 40°C environmental temperature only.

Typical filter attenuation

Per CISPR 17; A = 50Ω/50Ω sym; B = 50Ω/50Ω asym; C = 0.1Ω/100Ω sym; D = 100Ω/0.1Ω sym

8A types

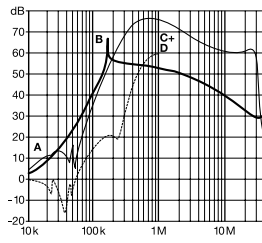

16A types

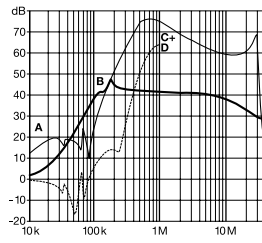

25A types

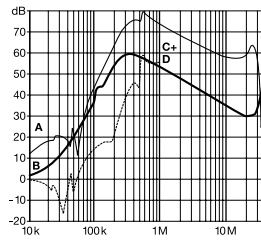

36A types

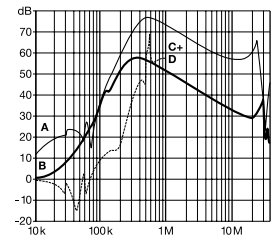

64A types

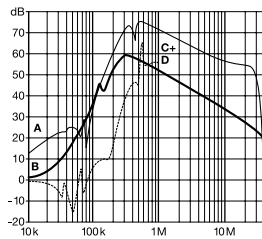

80A types

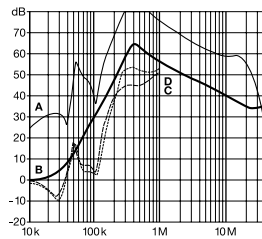

120A types

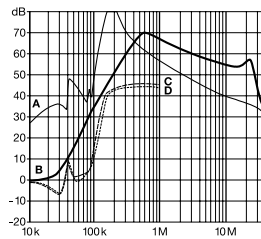

160A types

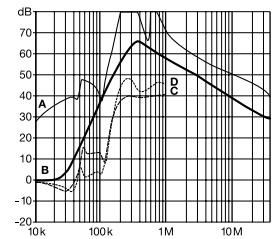

**Mechanical data**

8 to 64A types

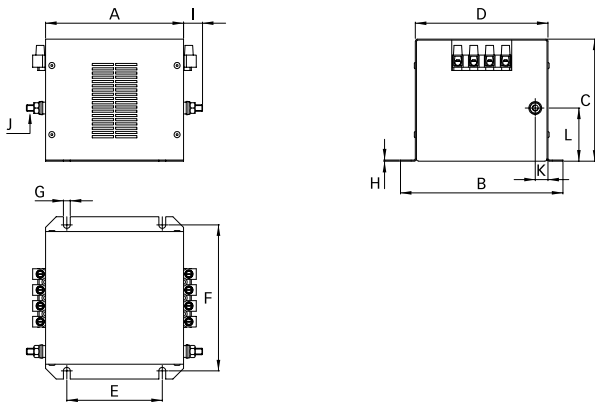

80 to 160A types (-28)

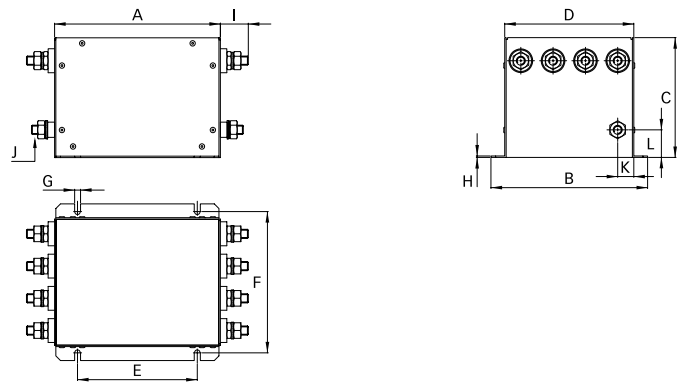

80 to 160A types (-34, -35, -40)

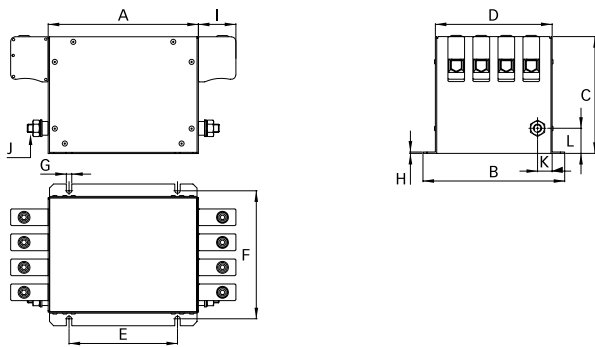

**Dimensions**

	8A	16A	25A	36A	64A	80A (-28)	80A (-34)	120A (-28)	120A (-35)	160A (-28)	160A (-40)
<b>A</b>	120	120	130	130	140	160	160	180	180	200	200
<b>B</b>	143	143	153	153	153	170	170	170	170	170	170
<b>C</b>	80	80	115	115	125	110	110	130	140	130	160
<b>D</b>	115	115	125	125	125	140	140	140	140	140	140
<b>E</b>	80	80	90	90	100	110	110	130	130	150	150
<b>F</b>	127.5	127.5	137.5	137.5	137.5	153.5	153.5	153.5	153.5	153.5	153.5
<b>G</b>	6.5	6.5	6.5	6.5	6.5	6.5	6.5	6.5	6.5	6.5	6.5
<b>H</b>	1	1	1	1	1.5	1.5	1.5	1.5	1.5	1.5	1.5
<b>I</b>	18	18	18	18	18	33.5	39	33.5	45	33.5	49.5
<b>J</b>	M6	M6	M6	M6	M6	M10	M10	M10	M10	M10	M10
<b>K</b>	12	12	13	13	13	17.5	17.5	17.5	17.5	17.5	17.5
<b>L</b>	33	33	50	50	50	30	30	30	30	30	30

All dimensions in mm; 1 inch = 25.4mm  
Tolerances according: ISO 2768-m / EN 22768-m

**Filter input/output connector cross sections**

	-28 (M10)	-34	-35	-40	-46	-47	-52
<b>Solid wire</b>	n/a	35mm <sup>2</sup>	50mm <sup>2</sup>	95mm <sup>2</sup>	10mm <sup>2</sup>	16mm <sup>2</sup>	25mm <sup>2</sup>
<b>Flex wire</b>	n/a	25mm <sup>2</sup>	50mm <sup>2</sup>	95mm <sup>2</sup>	6mm <sup>2</sup>	10mm <sup>2</sup>	16mm <sup>2</sup>
<b>AWG type wire</b>	n/a	AWG 2	AWG 1/0	AWG 4/0	AWG 10	AWG 8	AWG 4
<b>Recommended torque</b>	15 - 17Nm	4.0 - 4.5Nm	7 - 8Nm	17 - 20Nm	0.7 - 0.8Nm	1.9 - 2.2Nm	1.9 - 2.2Nm

Please visit [www.schaffner.com](http://www.schaffner.com) to find more details on filter connectors.

**Your local partner:** To find your local partner within Schaffner's global network, please go to [www.schaffner.com](http://www.schaffner.com)

**Headquarters and  
global innovation and  
development center**

**Schaffner Group**  
Nordstrasse 11  
4542 Luterbach  
Switzerland  
T +41 32 681 66 26  
F +41 32 681 66 30  
info@schaffner.ch  
[www.schaffner.com](http://www.schaffner.com)

**Sales and application centers**

**China**  
**Schaffner EMC Ltd. Shanghai**  
Building 11, Lane 1365  
East Kangqiao Road  
Shanghai 201319  
T +86 21 6813 9855  
F +86 21 6813 9811  
cschina@schaffner.com  
[www.schaffner.com](http://www.schaffner.com)

**Germany**  
**Schaffner Deutschland GmbH**  
Schoemperlenstrasse 12B  
76185 Karlsruhe  
T +49 721 56910  
F +49 721 569110  
germanysales@schaffner.com

**Finland**  
**Schaffner Oy**  
Tynninkuja 7  
08700 Lohja  
T +358 19 35 72 71  
F +358 19 32 66 10  
finlandsales@schaffner.com

**France**  
**Schaffner EMC S.A.S.**  
112, Quai de Bezons  
95103 Argenteuil  
T +33 1 34 34 30 60  
F +33 1 39 47 02 28  
francesales@schaffner.com

**Italy**  
**Schaffner EMC S.r.l.**  
Via Galileo Galilei, 47  
20092 Cinisello Balsamo (MI)  
T +39 02 66 04 30 45/47  
F +39 02 61 23 943  
italysales@schaffner.com

**Japan**  
**Schaffner EMC K.K.**  
Mitsui-Seimei Sangenjaya Bldg. 7F  
1-32-12, Kamiyama, Setagaya-ku  
Tokyo 154-0011  
T +81 3 5712 3650  
F +81 3 5712 3651  
japansales@schaffner.com  
[www.schaffner.jp](http://www.schaffner.jp)

**Sweden**  
**Schaffner EMC AB**  
Turebergstorg 1, 6  
19147 Sollentuna  
T +46 8 5792 1121/22  
F +46 8 92 96 90  
swedensales@schaffner.com

**Switzerland**  
**Schaffner EMV AG**  
Nordstrasse 11  
4542 Luterbach  
T +41 32 681 66 26  
F +41 32 681 66 41  
sales@schaffner.ch

**Singapore**  
**Schaffner EMC Pte Ltd.**  
Blk 3015A Ubi Road 1  
05-09 Kampong Ubi Industrial  
Estate  
T +65 6377 3283  
F +65 6377 3281  
singaporesales@schaffner.com

**Spain**  
**Schaffner EMC España**  
Calle Caléndula 93,  
Miniparc III, Edificio E  
El Soto de la Moraleja,  
Alcobendas  
28109 Madrid  
T +34 618 176 133  
spainsales@schaffner.com

**Taiwan**  
**Schaffner EMV Ltd.**  
6th Floor, No 413  
Rui Guang Road  
Neihu District  
Taipei City 114  
T +886 2 87525050  
F +886 2 87518086  
taiwansales@schaffner.com

**Thailand**  
**Schaffner EMC Co. Ltd.**  
Northern Region Industrial Estate  
67 Moo 4 Tambon Ban Klang  
Amphur Muang P.O. Box 14  
Lamphun 51000  
T +66 53 58 11 04  
F +66 53 58 10 19  
thailandsales@schaffner.com

**UK**  
**Schaffner Ltd.**  
5 Ashville Way  
Molly Millars Lane  
Wokingham  
Berkshire RG41 2PL  
T +44 118 9770070  
F +44 118 9792969  
uksales@schaffner.com  
[www.schaffner.uk.com](http://www.schaffner.uk.com)

**USA**  
**Schaffner EMC Inc.**  
52 Mayfield Avenue  
Edison, New Jersey 08837  
T +1 732 225 9533  
F +1 732 225 4789  
usasales@schaffner.com  
[www.schaffner.com/us](http://www.schaffner.com/us)

To find your local partner within  
Schaffner's global network, please go to

[www.schaffner.com](http://www.schaffner.com)

May 2011

© 2011 Schaffner EMC.  
Specifications subject to change without  
notice. All trademarks recognized.

Schaffner is an ISO-registered company.  
Its products are designed and manufac-  
tured under the strict quality and environ-  
mental requirements of the ISO 9001 and  
ISO 14001 standards.

This document has been carefully  
checked. However, Schaffner does not  
assume any liability for errors or inac-  
curacies.