

RoHS **PLED5HT SOT 89 Series**

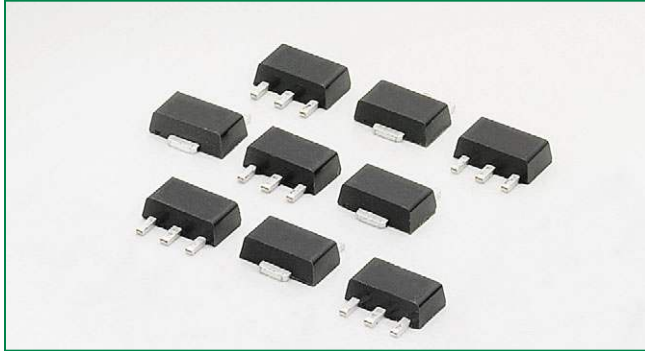

Schematic Symbol

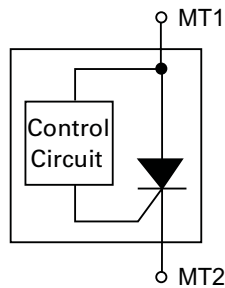

Description

This PLED5HT Open LED Protector device provides three methods for increasing the reliability of LED lighting:

- 1) If one of the LEDs in an array fails open, this device provides a substitute electronic path so that the array continues to function
- 2) It protects against ESD events up to ± 8 kV for contact discharges and ± 15 kV for air discharges per the IEC 61000-4-2 electrostatic immunity standard.
- 3) It provides protection in the case of accidental reverse battery or power connection.

High reliability of lighting functions such as traffic lighting, aircraft lighting, advertising lighting, and runway lighting demand the use of a device such as the PLED5HT.

Littelfuse offers over current devices for implementation in power circuits that can also enhance the reliability of circuit operation. Our full line of circuit protection products can be viewed at www.littelfuse.com.

Features & Benefits

- Reverse Battery/Power Protection
- Resets After Power Cycle
- Open LED bypass up to 700 mA
- Fast Switching
- ESD, IEC 61000-4-2, ± 8 kV contact, ± 15 kV air
- Low Turn-On (Trigger Voltage)
- SOT 89 Package

Electrical Characteristics

Symbol	Parameter	Conditions	MIN	TYP	MAX	Unit
V_{AK}	Input Voltage				38	V
V_{TO}	Turn-On Voltage		4.65	4.9	5.15	V
I_S	Switching Current				20	mA
V_{OS}	On-State Voltage	$I_{AK} = 700$ mA		1.6	1.8	V
I_{OS}	On-State Current	(with adequate heat sinking)			700	mA
V_{OSR}	Reverse On-State Voltage	$I = 700$ mA		1.6	1.8	V
I_{OSR}	Reverse On-State Current				700	mA
I_{DRM}	Leakage Current	$V_{AK} = 3.5$ V		100	150	μ A
V_{ESD}	ESD Withstand Voltage ¹	IEC61000-4-2 (Contact)		± 8		kV
		IEC61000-4-2 (Air)		± 15		kV

Notes: ¹Parameter is guaranteed by design and/or device characterization.

Thermal Considerations

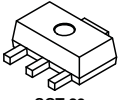
Package	Symbol	Parameter	Value	Unit
 SOT 89	T_{OP}	Operating Temperature	-40 to 85	°C
	T_J	Maximum Junction Temperature	150	°C
	T_{STOR}	Storage Temperature	-65 to 150	°C

V-I Characteristics

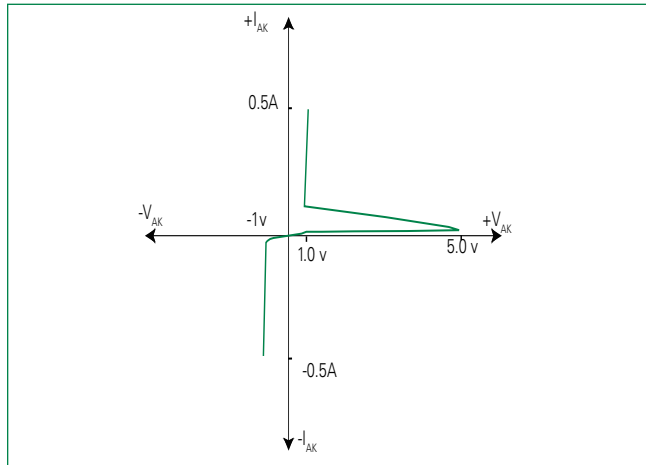

Switching Current vs Temperature

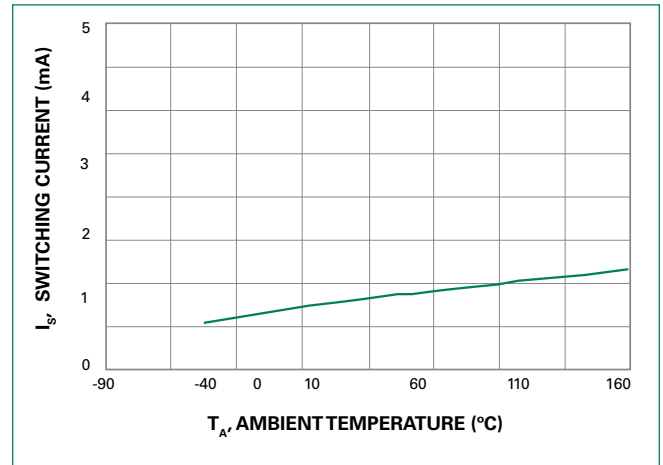

Turn-On Voltage vs Temperature

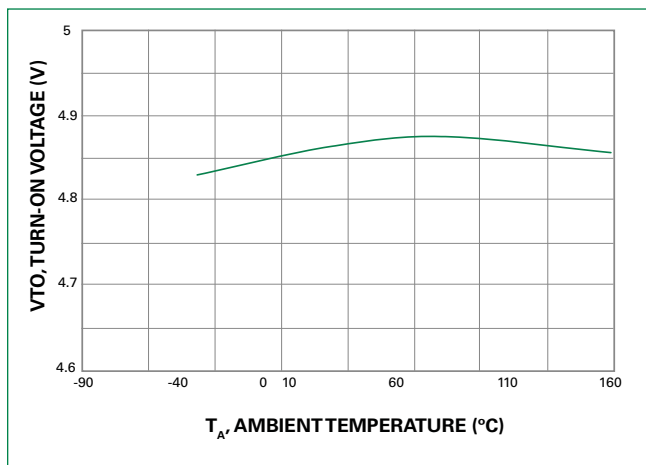

LED Application and Interference Test Circuit

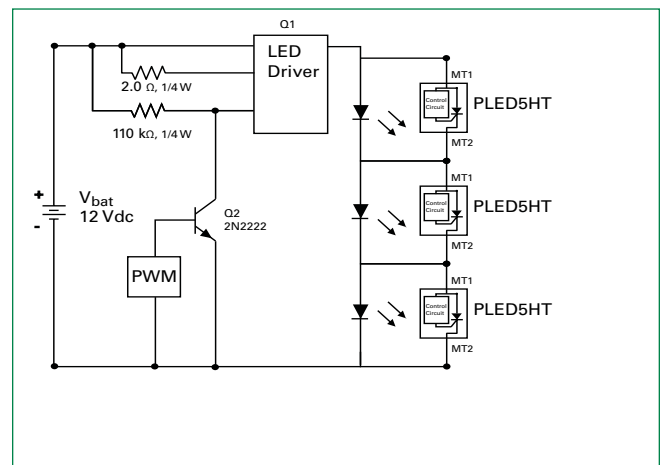

Leakage Current vs Temperature

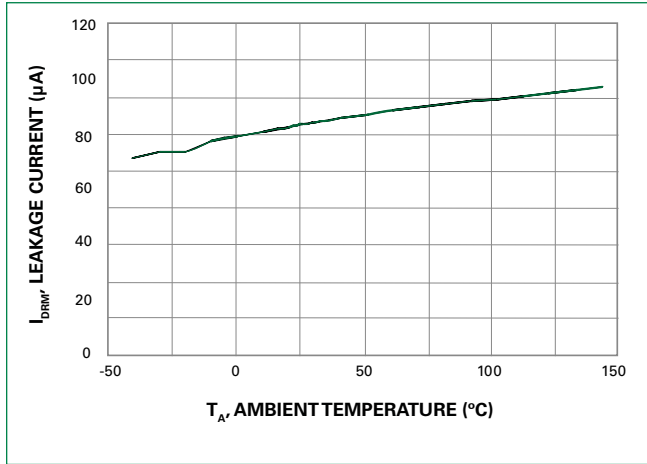

Ordering Information

Catalog Number	Package Type	Quantity Per Reel
PLED5HT	SOT 89	1000 Pieces

Package Dimensions – SOT-89

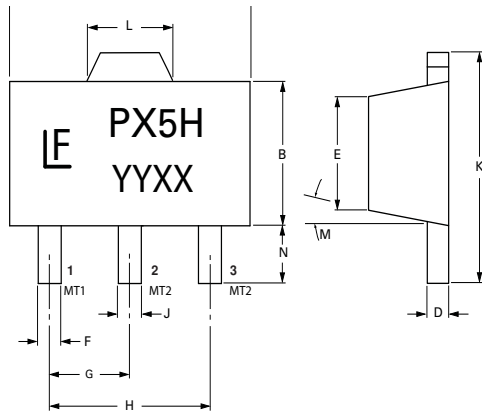

Dimension	Inches		Millimeters	
	Min	Max	Min	Max
A	0.173	0.181	4.39	4.59
B	0.090	0.102	2.28	2.59
C	0.055	0.063	1.39	1.60
D	0.015	0.017	0.38	0.43
E	0.084	0.090	2.13	2.28
F	0.016	0.019	0.33	0.48
G	0.059 BSC		1.49 BSC	
H	0.118 BSC		2.99 BSC	
J	0.018	0.022	0.45	0.55
K	0.155	0.167	3.94	4.24
L	0.067	0.072	1.70	1.82
M	0°	8°	0°	8°
N	0.035	0.047	0.89	1.19

Pad Layout for SOT-89

