

### RONDA-WAS

Asymmetric beam for wall washing with holder A compatible with 3rd party connectors from TE, Bender+Wirth and IDEAL

#### SPECIFICATION:

Dimensions	Ø 69.9 mm
Height	21.8 mm
Fastening	socket
ROHS compliant	yes ⓘ



#### MATERIALS:

Component	Type	Material	Colour	Finish
F15156_RONDA-WAS	Single lens	PMMA	clear	
F15155_RONDA-HLD-A	Holder	PC	white	

#### ORDERING INFORMATION:

##### Quantities for one set:

Single lens	1
Holder	1



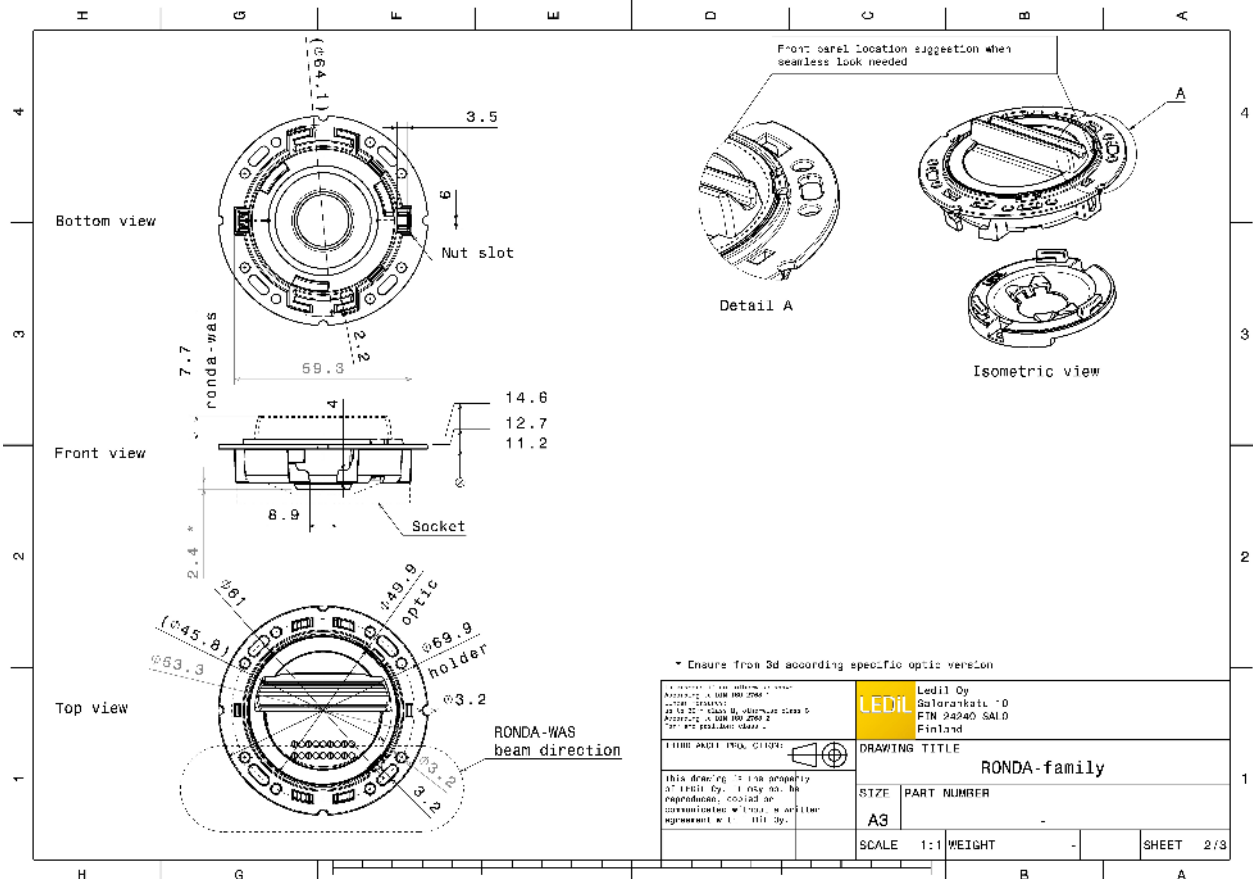
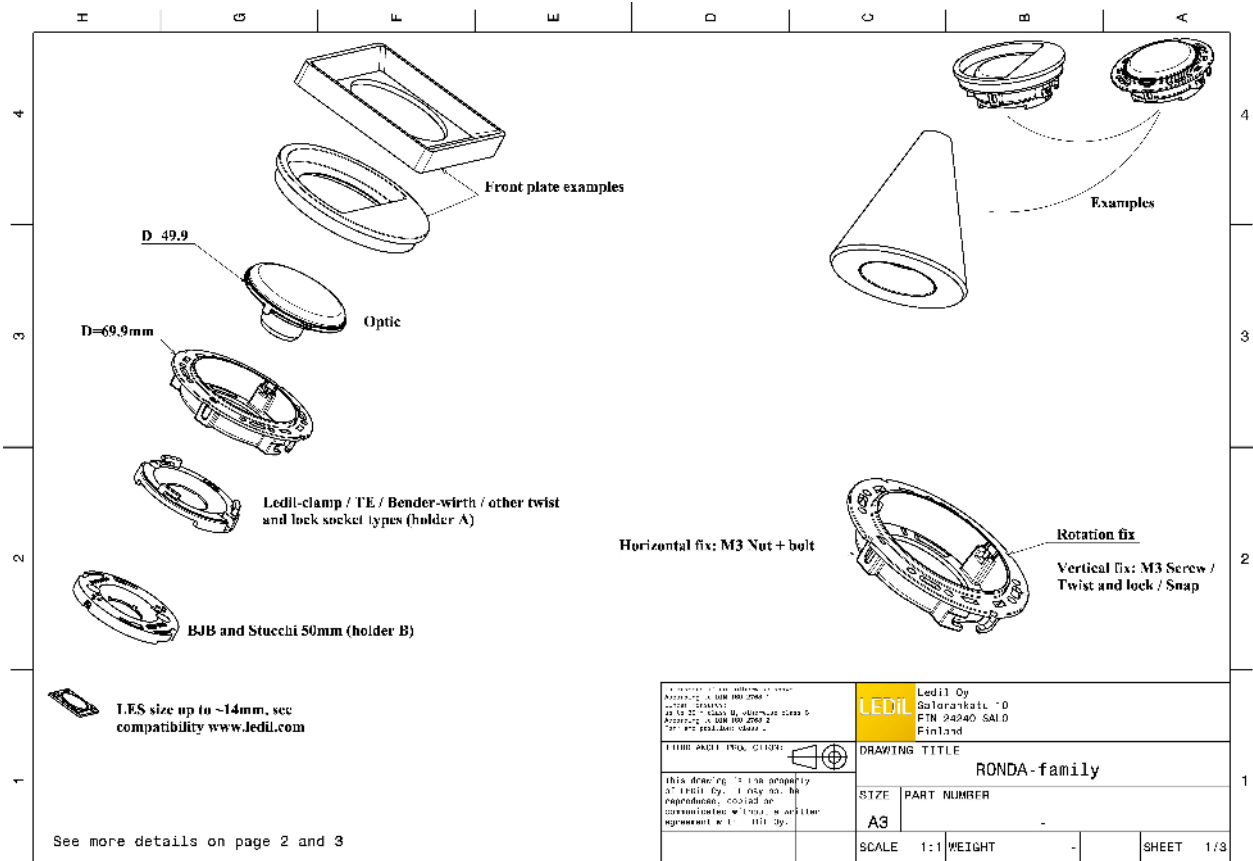

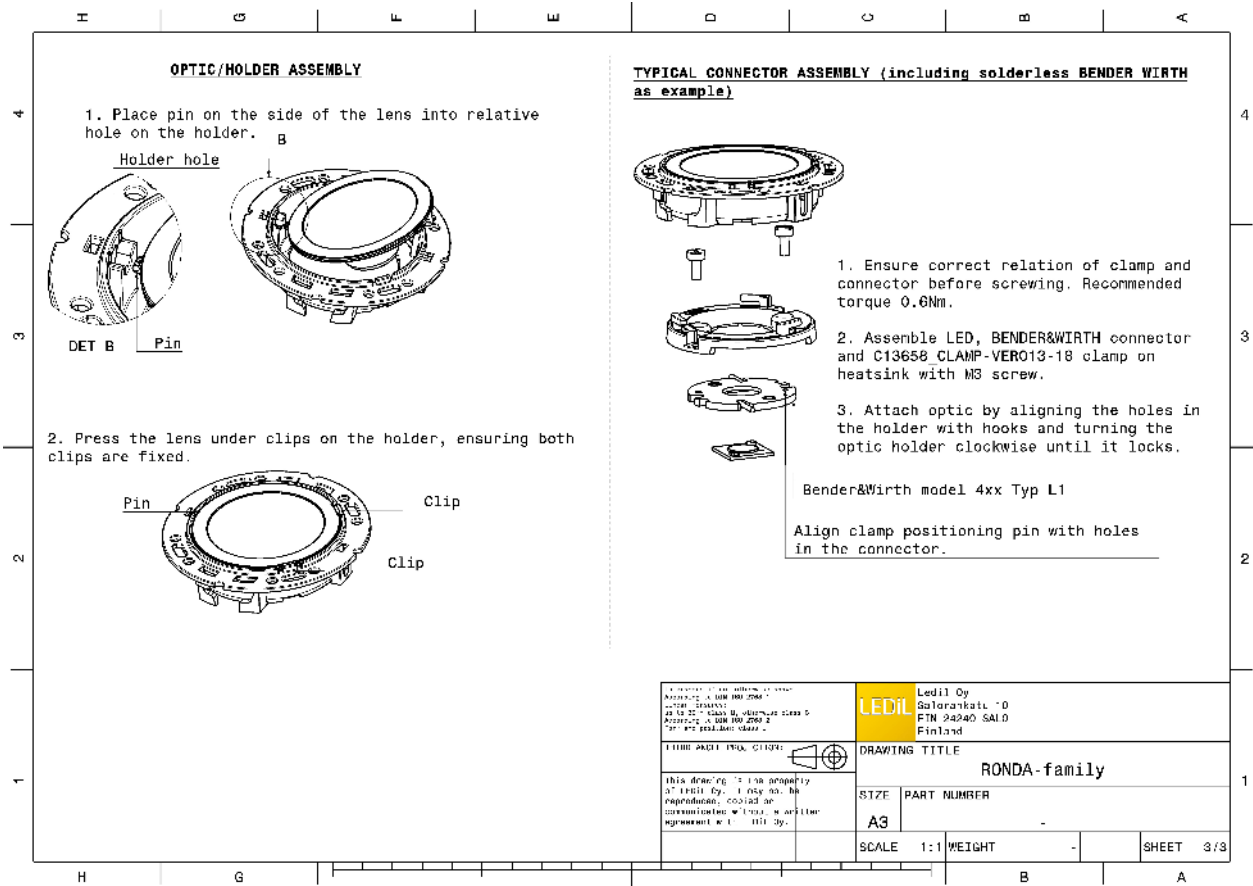

Component		Qty in box	MOQ	MPQ	Box weight (kg)
F15156_RONDA-WAS	Single lens	420	120	30	7.3
» Box size: 480 x 280 x 300 mm					
F15155_RONDA-HLD-A	Holder	420	120	30	4.4
» Box size: 480 x 280 x 300 mm					



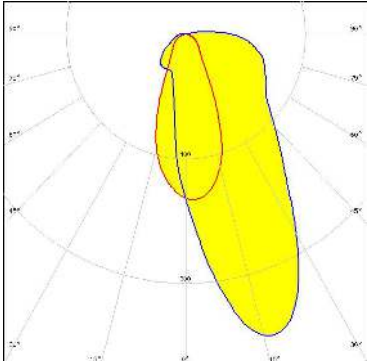

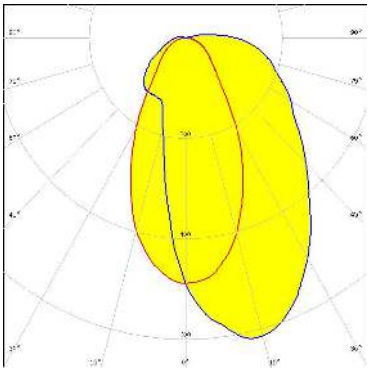
See also our general installation guide: [www.ledil.com/installation\\_guide](http://www.ledil.com/installation_guide)

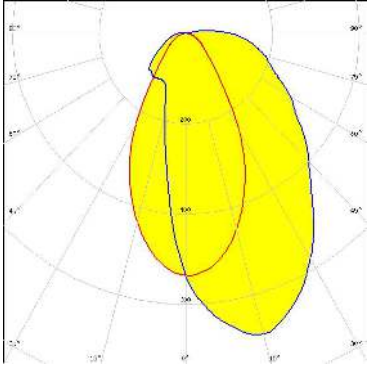
### OPTICAL RESULTS (MEASURED):

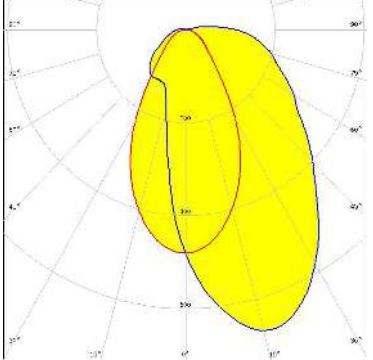
<p></p> <p>LED V10 Gen7            FWHM / FWTM Asymmetric            Efficiency 88 %            Peak intensity 1 cd/lm            LEDs/each optic 1            Light colour White            Required components:            C13658_CLAMP-VERO13-18            Bender Wirth: 486 Typ L1</p>		
<p></p> <p>LED V13 Gen7            FWHM / FWTM Asymmetric            Efficiency 84 %            Peak intensity 0.6 cd/lm            LEDs/each optic 1            Light colour White            Required components:            TE Connectivity: 2213254-2 + OPTIC CLIP Z50 TYPE1 2213194-1</p>		
<p></p> <p>LED Vero SE 13            FWHM / FWTM Asymmetric            Efficiency 89 %            Peak intensity 0.7 cd/lm            LEDs/each optic 1            Light colour White            Required components:            C16402_CLAMP-VEROSE-13-18</p>		
<p></p> <p>LED VERO13            FWHM / FWTM Asymmetric            Efficiency 89 %            Peak intensity 0.7 cd/lm            LEDs/each optic 1            Light colour White            Required components:            C13658_CLAMP-VERO13-18</p>		

### OPTICAL RESULTS (MEASURED):

#### CITIZEN

LED CLL03x/CLU03x  
 FWHM / FWTM Asymmetric  
 Efficiency 84 %  
 Peak intensity 0.6 cd/lm  
 LEDs/each optic 1  
 Light colour White  
 Required components:  
 IDEAL: 50-2103CT + 50-2100AN

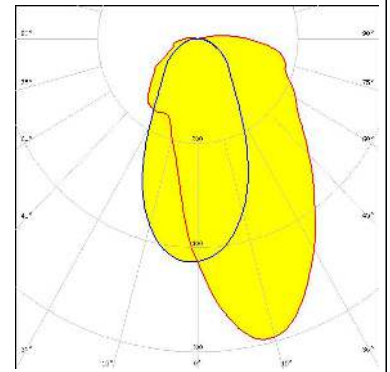

#### CITIZEN

LED CLL03x/CLU03x  
 FWHM / FWTM Asymmetric  
 Efficiency 87 %  
 Peak intensity 0.6 cd/lm  
 LEDs/each optic 1  
 Light colour White  
 Required components:  
 C16791\_CLAMP-Z45-A  
 TE Connectivity: 2325807-3

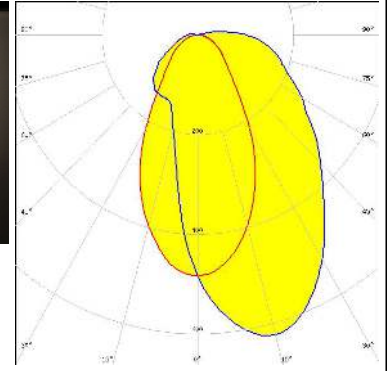

#### CITIZEN

LED CLL04x/CLU04x  
 FWHM / FWTM Asymmetric  
 Efficiency 84 %  
 Peak intensity 0.5 cd/lm  
 LEDs/each optic 1  
 Light colour White  
 Required components:  
 IDEAL: 50-2204-CT + 50-2100AN

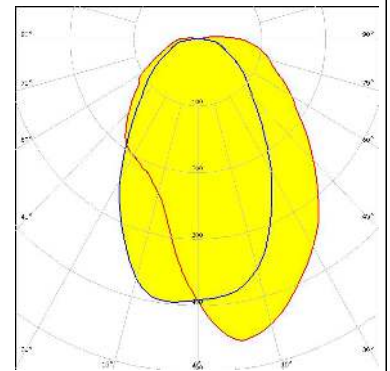

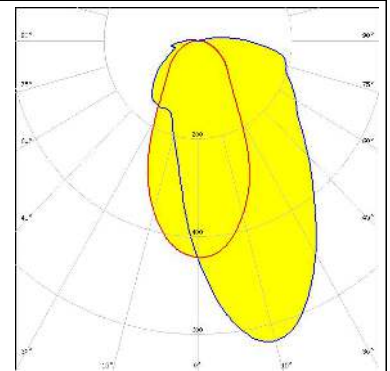

#### CITIZEN

LED CLU730/731/733  
 FWHM / FWTM Asymmetric  
 Efficiency 85 %  
 Peak intensity 0.6 cd/lm  
 LEDs/each optic 1  
 Light colour White  
 Required components:  
 IDEAL: 50-2204-CT + 50-2100AN

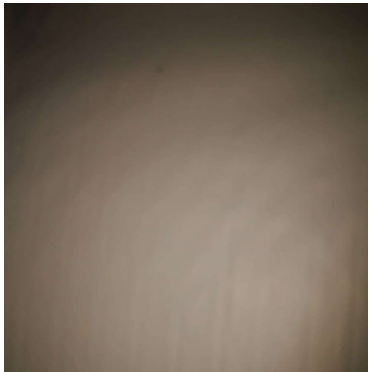
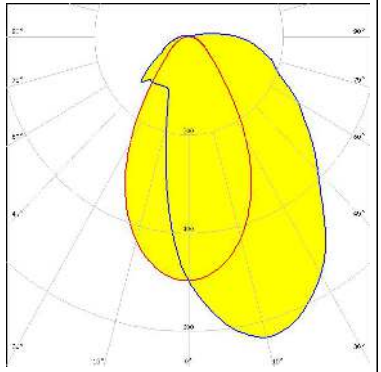
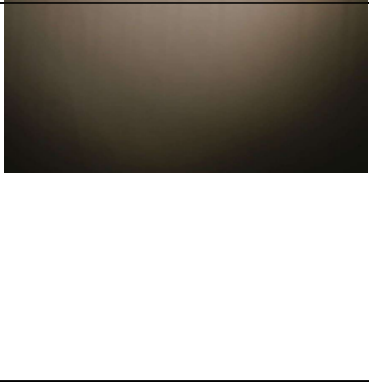
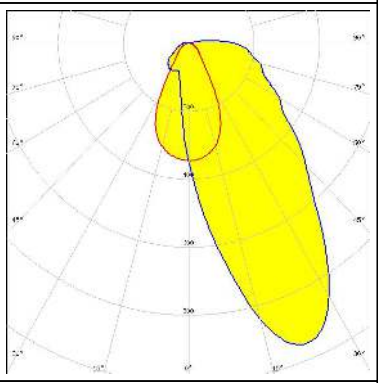
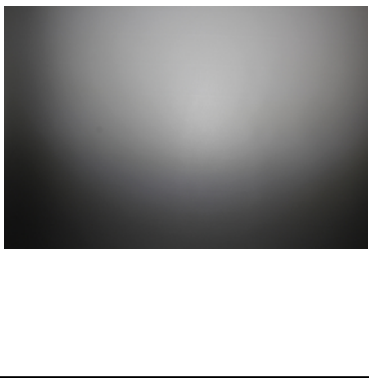
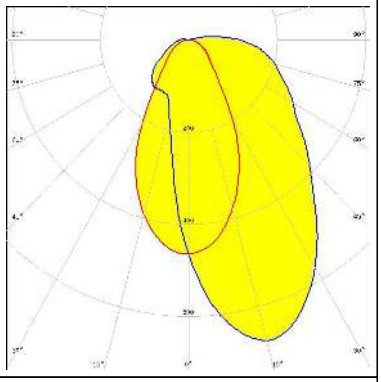

### OPTICAL RESULTS (MEASURED):

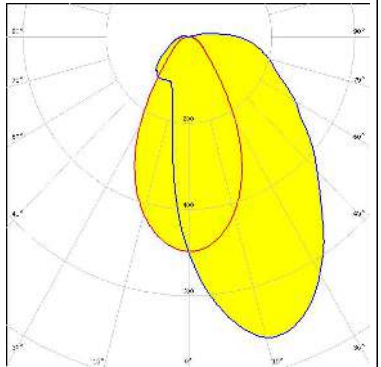
<p><b>CREE</b> ⇄ <b>LED</b></p> <p>LED CMA1840            FWHM / FWTM Asymmetric            Efficiency 89 %            Peak intensity 0.6 cd/lm            LEDs/each optic 1            Light colour White            Required components:            C14123_CLAMP-CXA15-18</p>		
<p><b>CREE</b> ⇄ <b>LED</b></p> <p>LED CXA/B 15xx            FWHM / FWTM Asymmetric            Efficiency 91 %            Peak intensity 1 cd/lm            LEDs/each optic 1            Light colour White            Required components:            C14123_CLAMP-CXA15-18</p>		
<p><b>CREE</b> ⇄ <b>LED</b></p> <p>LED CXA/B 1816 &amp; CXA/B 1820 &amp; CXA 1850            FWHM / FWTM Asymmetric            Efficiency 87 %            Peak intensity 0.7 cd/lm            LEDs/each optic 1            Light colour White            Required components:            TE Connectivity: 2213401-2 + OPTIC CLIP Z50 TYPE1 2213194-1</p>		
<p><b>CREE</b> ⇄ <b>LED</b></p> <p>LED CXA/B 1816 &amp; CXA/B 1820 &amp; CXA 1850            FWHM / FWTM Asymmetric            Efficiency 91 %            Peak intensity 0.7 cd/lm            LEDs/each optic 1            Light colour White            Required components:            C14123_CLAMP-CXA15-18</p>		

### OPTICAL RESULTS (MEASURED):



LED COB J-Type  
 FWHM / FWTM Asymmetric  
 Efficiency 83 %  
 Peak intensity 0.6 cd/lm  
 LEDs/each optic 1  
 Light colour White  
 Required components:  
 IDEAL: 50-2103NC + 50-2100AN

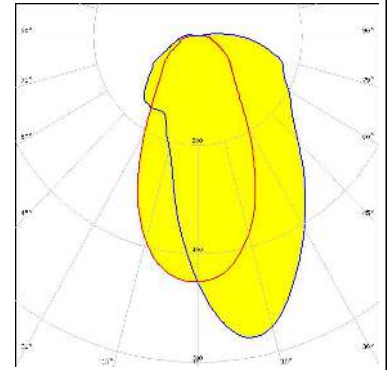

LED COB L-Type (LES 11)  
 FWHM / FWTM Asymmetric  
 Efficiency 84 %  
 Peak intensity 0.8 cd/lm  
 LEDs/each optic 1  
 Light colour White  
 Required components:  
 IDEAL: 50-2100NC + 50-2100AN

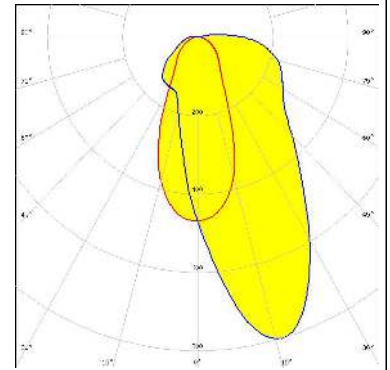

LED COB L-Type (LES 11)  
 FWHM / FWTM Asymmetric  
 Efficiency 87 %  
 Peak intensity 0.8 cd/lm  
 LEDs/each optic 1  
 Light colour White  
 Required components:  
 TE Connectivity: 2213382-2 + OPTIC CLIP Z50 TYPE1 2213194-1

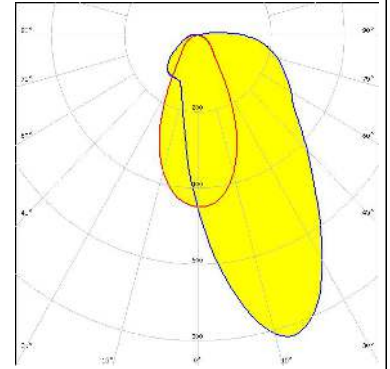

LED PrevaLED Core G7 L15 H1  
 FWHM / FWTM Asymmetric  
 Efficiency 78 %  
 Peak intensity 0.6 cd/lm  
 LEDs/each optic 1  
 Light colour White  
 Required components:  
 C16685\_CLAMP-PRV-A

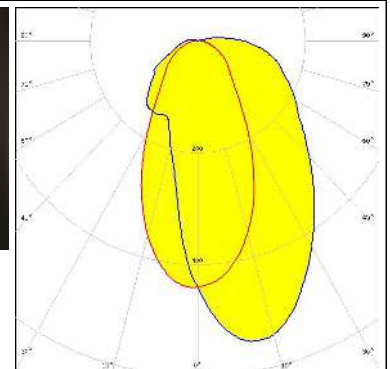



### OPTICAL RESULTS (MEASURED):

#### OSRAM

Opto Semiconductors

LED Soleriq S13 19x19  
FWHM / FWTM Asymmetric  
Efficiency 86 %  
Peak intensity 0.7 cd/lm  
LEDs/each optic 1  
Light colour White

Required components:

TE Connectivity: 2213254-2 + OPTIC CLIP Z50 TYPE1 2213194-1

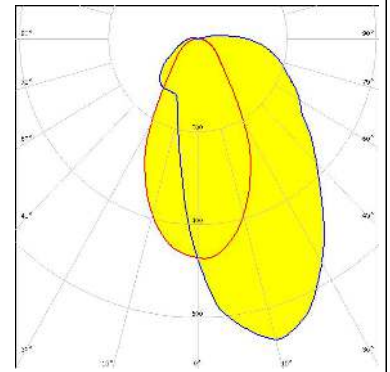

#### OSRAM

Opto Semiconductors

LED Soleriq S13 19x19  
FWHM / FWTM Asymmetric  
Efficiency 85 %  
Peak intensity 0.7 cd/lm  
LEDs/each optic 1  
Light colour White

Required components:

IDEAL: 50-2103CT + 50-2100AN

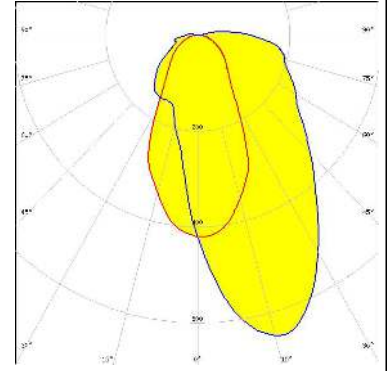

#### PHILIPS

LED Fortimo SLM L13 + SLM holder  
FWHM / FWTM Asymmetric  
Efficiency 83 %  
Peak intensity 0.6 cd/lm  
LEDs/each optic 1  
Light colour White

Required components:

TE Connectivity: OPTIC CLIP Z50 TYPE1 2213194-1

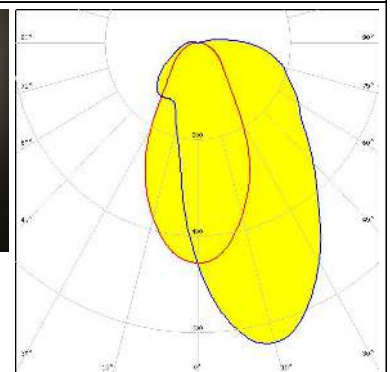
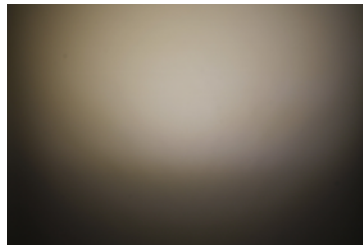

#### PHILIPS

LED Fortimo SLM L13 CoB  
FWHM / FWTM Asymmetric  
Efficiency 85 %  
Peak intensity 0.7 cd/lm  
LEDs/each optic 1  
Light colour White

Required components:

TE Connectivity: 2213130-2 + OPTIC CLIP Z50 TYPE1 2213194-1

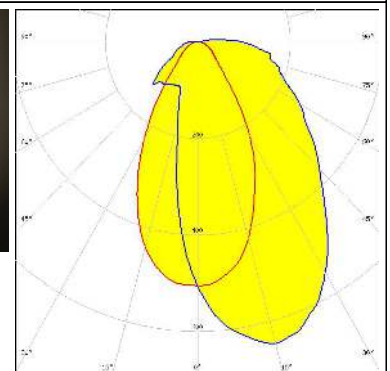
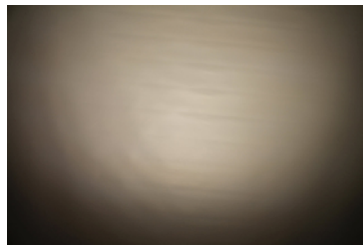

### OPTICAL RESULTS (MEASURED):

#### PHILIPS

LED Fortimo SLM L15 + SLM holder  
 FWHM / FWTM Asymmetric  
 Efficiency 82 %  
 Peak intensity 0.5 cd/lm  
 LEDs/each optic 1  
 Light colour White  
 Required components:  
 TE Connectivity: OPTIC CLIP Z50 TYPE1 2213194-1

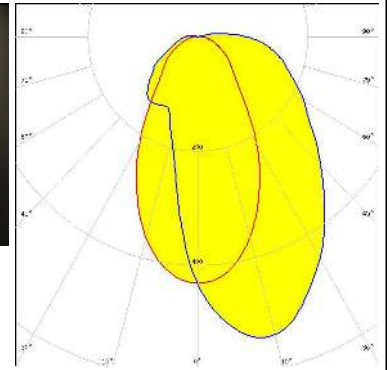

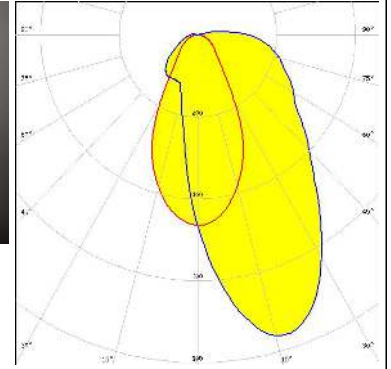

#### SAMSUNG

LED LC040C  
 FWHM / FWTM Asymmetric  
 Efficiency 88 %  
 Peak intensity 0.8 cd/lm  
 LEDs/each optic 1  
 Light colour White  
 Required components:  
 TE Connectivity: 2213382-2 + OPTIC CLIP Z50 TYPE1 2213194-1

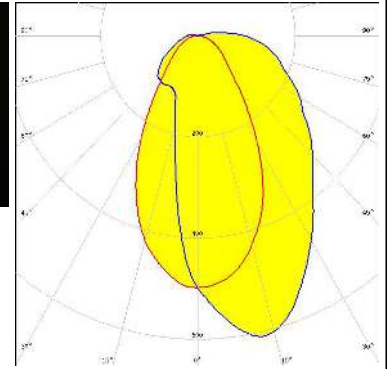
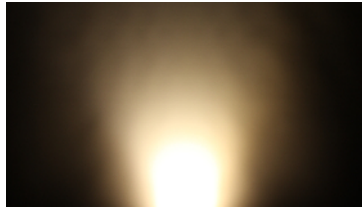

 SEUL SEMICONDUCTOR  
 LED AC Zhaga COB  
 FWHM / FWTM Asymmetric  
 Efficiency 86 %  
 Peak intensity 0.6 cd/lm  
 LEDs/each optic 1  
 Light colour White  
 Required components:  
 Optosource: SEHSMJD-A



 SEUL SEMICONDUCTOR  
 LED MJT COB LES 14.5  
 FWHM / FWTM Asymmetric  
 Efficiency 82 %  
 Peak intensity 0.5 cd/lm  
 LEDs/each optic 1  
 Light colour White  
 Required components:  
 TE Connectivity: 2213254-2 + OPTIC CLIP Z50 TYPE1 2213194-1

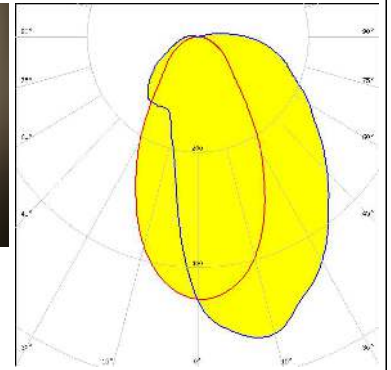

### OPTICAL RESULTS (MEASURED):





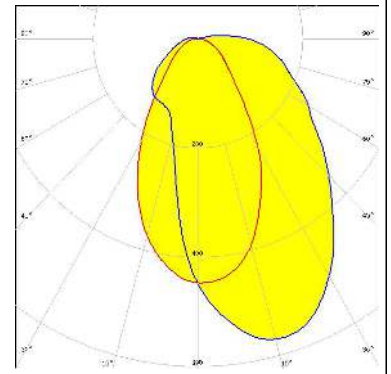

LED WU-M-484  
FWHM / FWTM Asymmetric  
Efficiency 84 %  
Peak intensity 0.6 cd/lm  
LEDs/each optic 1  
Light colour White

Required components:

TE Connectivity: OPTIC CLIP Z50 TYPE1 2213194-1

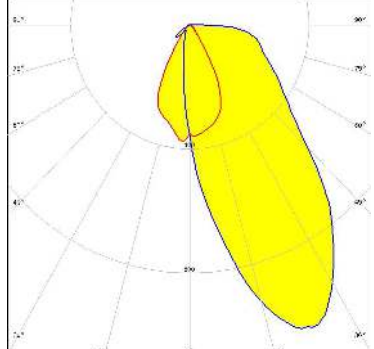

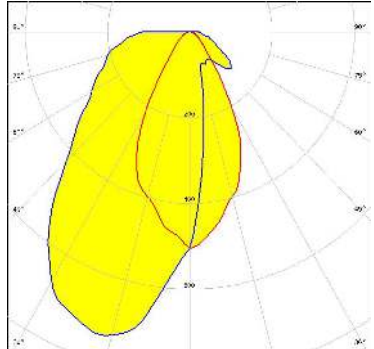
### OPTICAL RESULTS (SIMULATED):

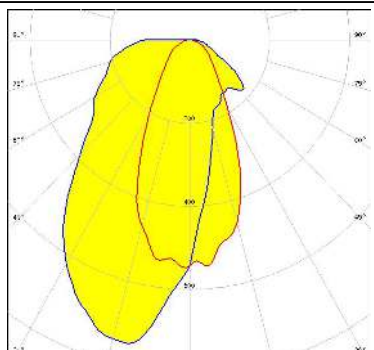
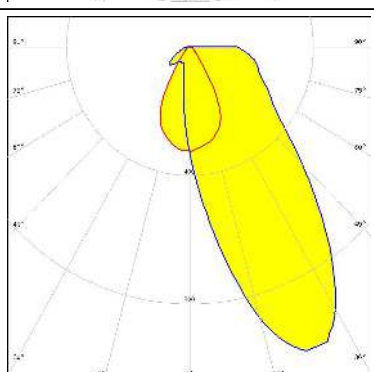
<p> LED V10 Gen6</p> <p>FWHM / FWTM Asymmetric</p> <p>Efficiency 84 %</p> <p>Peak intensity 1.1 cd/lm</p> <p>LEDs/each optic 1</p> <p>Light colour White</p> <p>Required components: C14123_CLAMP-CXA15-18</p>	
<p> LED V13 Gen7</p> <p>FWHM / FWTM Asymmetric</p> <p>Efficiency 84 %</p> <p>Peak intensity 0.7 cd/lm</p> <p>LEDs/each optic 1</p> <p>Light colour White</p> <p>Required components: C13658_CLAMP-VERO13-18 Bender Wirth: 477 Typ L1</p>	
<p> LED V13 Gen7</p> <p>FWHM / FWTM Asymmetric</p> <p>Efficiency 89 %</p> <p>Peak intensity 0.8 cd/lm</p> <p>LEDs/each optic 1</p> <p>Light colour White</p> <p>Required components: IDEAL: 50-2103CT + 50-2100AN</p>	
<p><b>CITIZEN</b></p> <p>LED CLL02x/CLU02x (LES10)</p> <p>FWHM / FWTM Asymmetric</p> <p>Efficiency 86 %</p> <p>Peak intensity 1 cd/lm</p> <p>LEDs/each optic 1</p> <p>Light colour White</p> <p>Required components: C13658_CLAMP-VERO13-18 Bender Wirth: 434 Typ L1</p>	

### OPTICAL RESULTS (SIMULATED):

#### CITIZEN

LED CLU700/701/702/703  
 FWHM / FWTM Asymmetric  
 Efficiency 86 %  
 Peak intensity 1.2 cd/lm  
 LEDs/each optic 1  
 Light colour White  
 Required components:  
 C13658\_CLAMP-VERO13-18  
 Bender Wirth: 434 Typ L1

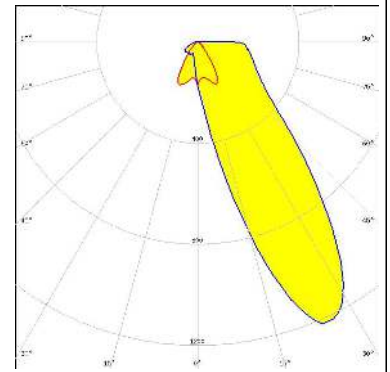

#### CITIZEN

LED CLU710/711  
 FWHM / FWTM Asymmetric  
 Efficiency 86 %  
 Peak intensity 1.1 cd/lm  
 LEDs/each optic 1  
 Light colour White  
 Required components:  
 C13658\_CLAMP-VERO13-18  
 Bender Wirth: 470 Typ L1

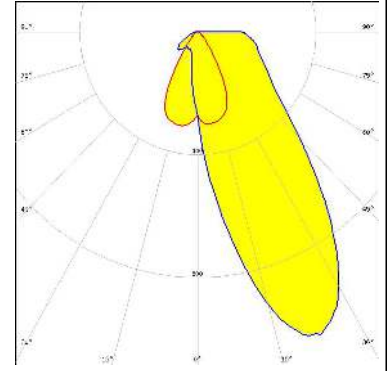

#### CREE LED

LED CXA/B 13xx  
 FWHM / FWTM Asymmetric  
 Efficiency 87 %  
 Peak intensity 1.2 cd/lm  
 LEDs/each optic 1  
 Light colour White  
 Required components:  
 C13658\_CLAMP-VERO13-18  
 Bender Wirth: 448 Typ L1

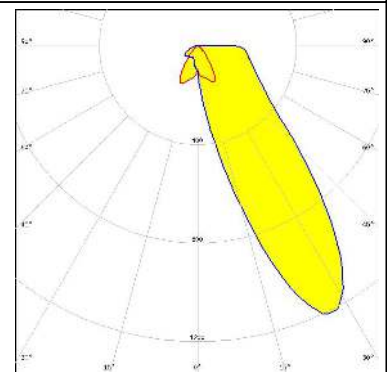

#### CREE LED

LED CXA/B 15xx  
 FWHM / FWTM Asymmetric  
 Efficiency 86 %  
 Peak intensity 1.1 cd/lm  
 LEDs/each optic 1  
 Light colour White  
 Required components:  
 C13658\_CLAMP-VERO13-18  
 Bender Wirth: 441 Typ L1

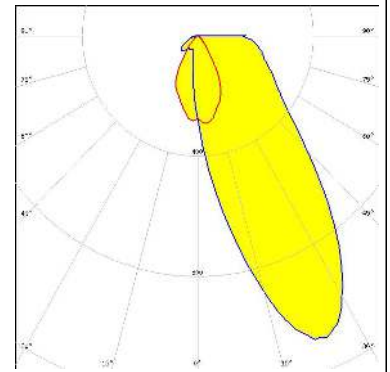

### OPTICAL RESULTS (SIMULATED):

#### CREE LED

LED CXA/B 1816 & CXA/B 1820 & CXA 1850  
 FWHM / FWTM Asymmetric  
 Efficiency 86 %  
 Peak intensity 1 cd/lm  
 LEDs/each optic 1  
 Light colour White  
 Required components:  
 C13658\_CLAMP-VERO13-18  
 Bender Wirth: 437 Typ L1

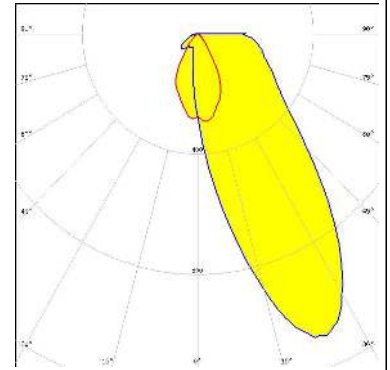

#### CREE LED

LED CXA/B 1830  
 FWHM / FWTM Asymmetric  
 Efficiency 85 %  
 Peak intensity 0.9 cd/lm  
 LEDs/each optic 1  
 Light colour White  
 Required components:  
 C14123\_CLAMP-CXA15-18

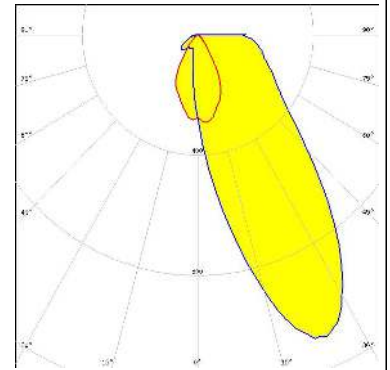

#### LUMILEDS

LED LUXEON CoB 1202/1203  
 FWHM / FWTM Asymmetric  
 Efficiency 85 %  
 Peak intensity 1 cd/lm  
 LEDs/each optic 1  
 Light colour White  
 Required components:  
 TE Connectivity: 2213382-2 + OPTIC CLIP Z50 TYPE1 2213194-1

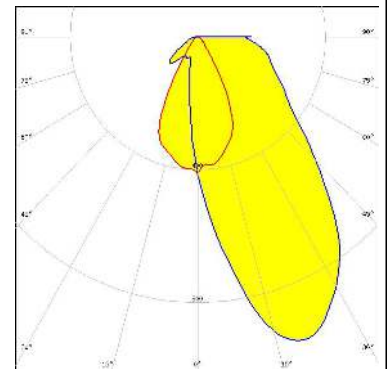

#### LUMILEDS

LED LUXEON CoB 1202s  
 FWHM / FWTM Asymmetric  
 Efficiency 86 %  
 Peak intensity 1.2 cd/lm  
 LEDs/each optic 1  
 Light colour White  
 Required components:  
 C13658\_CLAMP-VERO13-18  
 Bender Wirth: 452 Typ L1

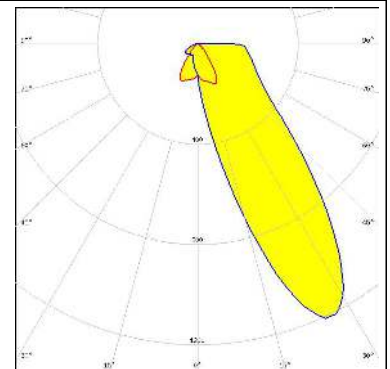

### OPTICAL RESULTS (SIMULATED):

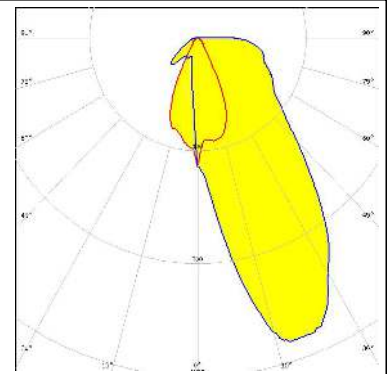
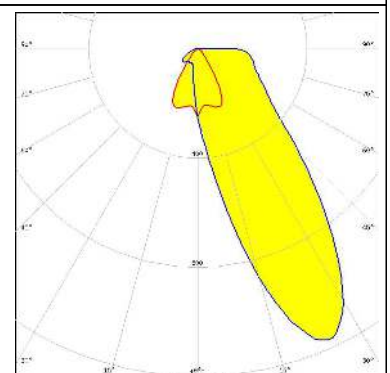
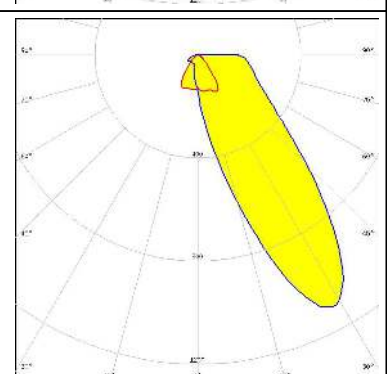
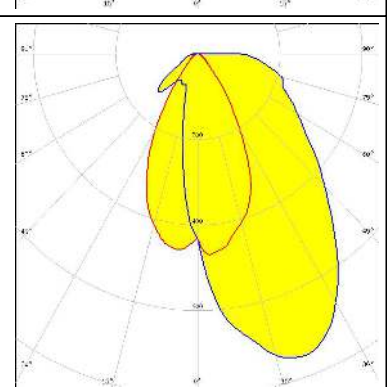
<p><b>NICHIA</b></p> <p>LED COB L-Type (LES 9)</p> <p>FWHM / FWTM Asymmetric</p> <p>Efficiency 85 %</p> <p>Peak intensity 1.1 cd/lm</p> <p>LEDs/each optic 1</p> <p>Light colour White</p> <p>Required components: TE Connectivity: 2213382-2 + OPTIC CLIP Z50 TYPE1 2213194-1</p>	
<p><b>NICHIA</b></p> <p>LED NSCxL036A</p> <p>FWHM / FWTM Asymmetric</p> <p>Efficiency 86 %</p> <p>Peak intensity 1.2 cd/lm</p> <p>LEDs/each optic 1</p> <p>Light colour White</p> <p>Required components: TE Connectivity: 2213382-2 + OPTIC CLIP Z50 TYPE1 2213194-1</p>	
<p><b>OSRAM</b> Opto Semiconductors</p> <p>LED Duris S10</p> <p>FWHM / FWTM Asymmetric</p> <p>Efficiency 86 %</p> <p>Peak intensity 1.1 cd/lm</p> <p>LEDs/each optic 1</p> <p>Light colour White</p> <p>Required components: C13658_CLAMP-VERO13-18</p>	
<p><b>OSRAM</b> Opto Semiconductors</p> <p>LED Soleriq S13</p> <p>FWHM / FWTM Asymmetric</p> <p>Efficiency 82 %</p> <p>Peak intensity 0.8 cd/lm</p> <p>LEDs/each optic 1</p> <p>Light colour White</p> <p>Required components: C14123_CLAMP-CXA15-18</p>	

### OPTICAL RESULTS (SIMULATED):

#### OSRAM

Opto Semiconductors

LED Soleriq S9  
FWHM / FWTM Asymmetric  
Efficiency 86 %  
Peak intensity 0.9 cd/lm  
LEDs/each optic 1  
Light colour White

Required components:

C13658\_CLAMP-VERO13-18  
Bender Wirth: 434 Typ L1

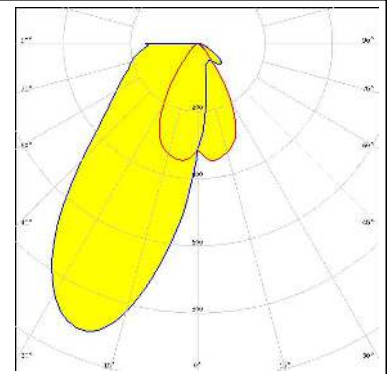

#### SHARP

LED Mini Zenigata (GW6BM)  
FWHM / FWTM Asymmetric  
Efficiency 85 %  
Peak intensity 1.1 cd/lm  
LEDs/each optic 1  
Light colour White

Required components:

C13658\_CLAMP-VERO13-18  
Bender Wirth: 452 Typ L1

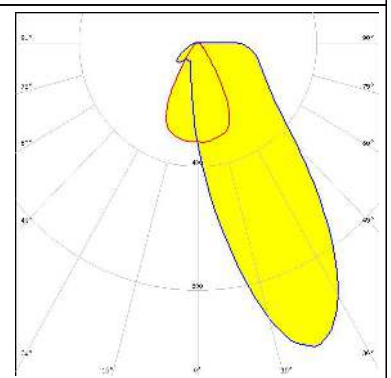



### GENERAL INFORMATION:

NOTE: The typical beam angle will be changed by different color, chip size and chip position tolerance. The typical total beam angle is the full angle measured where the luminous intensity is half of the peak value.

Due to use of high power COB's with this product, special attention to proper thermal design is highly recommended. LEDiL has no liability for direct, indirect or consecutive damages arising from the LEDiL products being used outside of the recommended temperature range.

### MATERIALS:

As part of our continuous research and improvement processes, and to ensure the best possible quality and availability of our products, LEDiL reserves the right to change material grades without notice.

### PRODUCT DATA USER AGREEMENT AND DISCLAIMER:

The measured data in the provided downloadable LEDiL Product Datasheets and Mechanical 2D-Drawings is rounded and provided as reference for planning. LEDiL Oy's optical specifications have been verified by conducting performance testing of the products in accordance with the company's quality system. The reported data are averaged results of multiple measurements with typical variation. LEDiL Oy reserves the right to without prior notification make changes and improvements to its products.

LEDiL Oy assumes neither warranty, nor guarantee nor any other liability of any kind for the contents and correctness of the provided data. The provided data has been generated with highest diligence but the provided data may in reality not represent the complete possible variation range of all intrinsic parameters. Therefore, in certain cases a deviation from the provided data could occur.

LEDiL Oy reserves the right to undertake technical changes of its products without further notification which could lead to changes in the provided data. LEDiL Oy assumes no liability of any kind for the possible deviation from any provided data or any other damage resulting from the usage of the provided data.

The user agrees to this disclaimer and user agreement with the download or usage of the provided files.

#### LEDiL Oy

Joensuunkatu 13  
FI-24240 SALO  
Finland

#### LEDiL Inc.

228 West Page Street  
Suite D  
Sycamore IL 60178  
USA

#### Ledil Optics Technology (Shenzhen) Co., Ltd.

# 405 , Block B  
Casic Motor Building  
Shenzhen 518057  
P.R.CHINA

#### Local sales and technical support

[www.ledil.com/  
where\\_to\\_buy](http://www.ledil.com/where_to_buy)

#### Shipping locations

Salo, Finland  
Hong Kong, China

#### Distribution Partners

[www.ledil.com/  
where\\_to\\_buy](http://www.ledil.com/where_to_buy)