

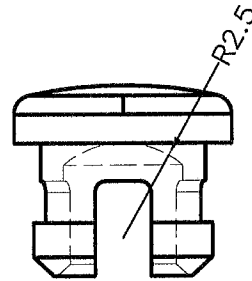

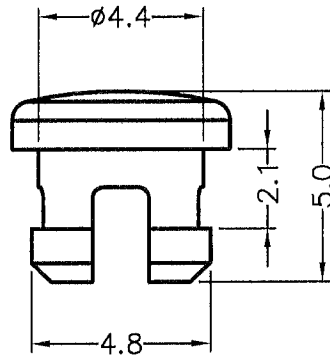

DIM.	TOL
L≤10	±0.2
10<L≤30	±0.3
30<L≤50	±0.5
50<L≤100	±0.7
100<L≤250	±1.2
ABOVE 250	±1.5

REVISIONS			
REV	DESCRIPTION	DATE	BY

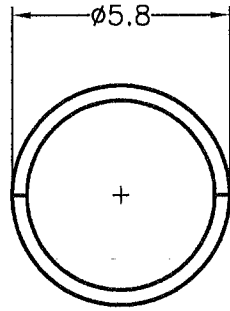
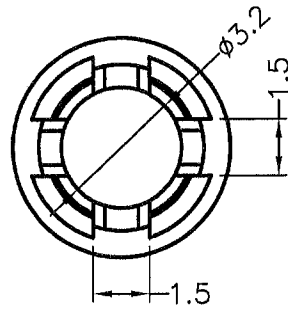

CHASSIS $\phi 4.6$
THICKNESS 2.0



 <p>康揚企業股份有限公司 KANG YANG HARDWARE ENTERPRISE CO., LTD. 康揚塑膠(東莞)有限公司 KANG YANG PLASTIC(DONG GUAN) CO., LTD. 康哲電腦配件(吳江)有限公司 KANG CHE COMPUTER COMPONENTS(WUJIANG) CO., LTD.</p>				TITLE	LIGHT PIPE	SPEC. DWG.	
				MATERIAL	PC UL94V-2	DATE	2011.10.21
				FINISH		DRAWN	SAI
				COLOR	TRANSPARENT	CHECK	
PART NUMBER	LEM-123	DRAWING NUMBER	LEM-123	UNLESS OTHERWISE SPECIFIED TOLERANCE	SEE ABOVE	APPROVED	
SIZE	A4	SCALE	5:1	UNIT	mm	REV	A