



CERAMIC

High Pass Filter

HFCN-1910+

Mini-Circuits

50Ω 2000 to 5200 MHz

THE BIG DEAL

- Low cost
- Small size
- 7 sections
- Temperature stable
- LTCC construction
- Excellent power handling, 7W
- Hermetically sealed

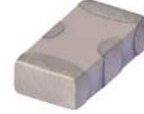

Generic photo used for illustration purposes only

CASE STYLE: FV1206

+RoHS Compliant

The +Suffix identifies RoHS Compliance. See our web site for RoHS Compliance methodologies and qualifications

APPLICATIONS

- Sub-harmonic rejection
- Transmitters/receivers
- Lab use

ELECTRICAL SPECIFICATIONS^{1,2} AT 25°C

Parameter	Frequency (MHz)	Min.	Typ.	Max.	Units
Stop Band	Rejection Loss	1075	40	—	—
		1400	20	—	—
	Freq. Cut-Off	1910	—	3.0	—
	VSWR	1075-1400	—	20	—
Pass Band	Insertion Loss	2000-5200	—	2.0	—
		2200-4400	—	—	1.3
	VSWR	2100-4500	—	1.5	—

1. In Application where DC voltage is present at either input or output ports, coupling capacitors are required. Alternatively, Mini-Circuits' "D" suffix version of this model will provide >100 MOhm isolation to ground.

2. Measured on Mini-Circuits Characterization Test Board TB-270.

MAXIMUM RATINGS

Parameter	Ratings
Operating temperature	-55°C to +100°C
Storage temperature	-55°C to +100°C
RF Power Input ³	7W max.at 25°C

3. Passband rating, derate linearly to 3W at 100°C ambient. Permanent damage may occur if any of these limits are exceeded.

TYPICAL FREQUENCY RESPONSE

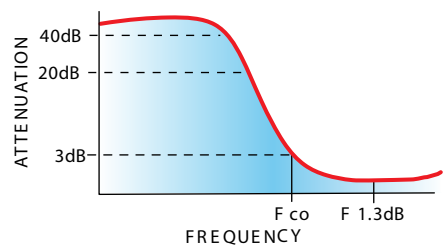

FUNCTIONAL SCHEMATIC

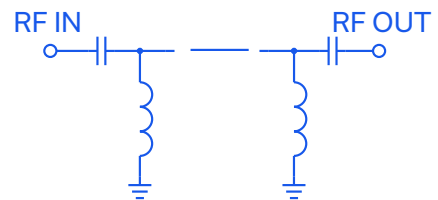

REV. L
ECO-012088
HFCN-1910+
RVN/AD/CP/AM
220221





PIN CONNECTIONS

RF IN	1
RF OUT	3
GROUND	2,4

PRODUCT MARKING: N/A

DEMO BOARD MCL P/N: TB-270
SUGGESTED PCB LAYOUT (PL-137)

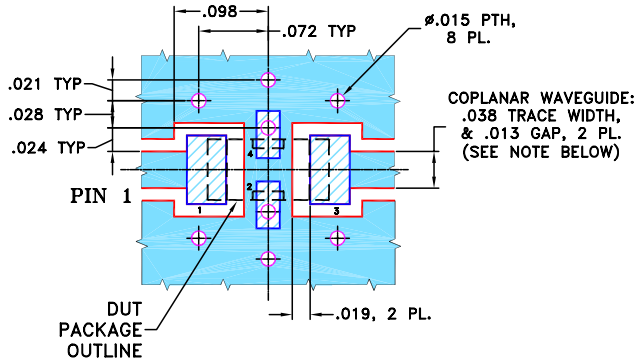

- NOTES:**
1. COPLANAR WAVEGUIDE PARAMETERS ARE SHOWN FOR ROGERS RO4350B WITH THICKNESS .020" ± .0015". COPPER: 1/2 OZ. EACH SIDE. FOR OTHER MATERIALS TRACE WIDTH & GAP MAY NEED TO BE MODIFIED.
 2. BOTTOM SIDE OF THE PCB IS CONTINUOUS GROUND PLANE.

- DENOTES PCB COPPER LAYOUT WITH SMOBC (SOLDER MASK OVER BARE COPPER)
- DENOTES COPPER LAND PATTERN FREE OF SOLDER MASK

OUTLINE DRAWING

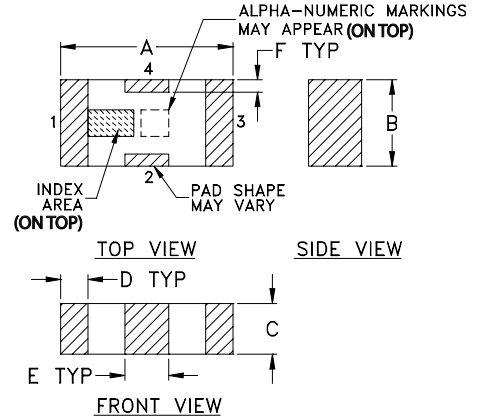

PCB Land Pattern

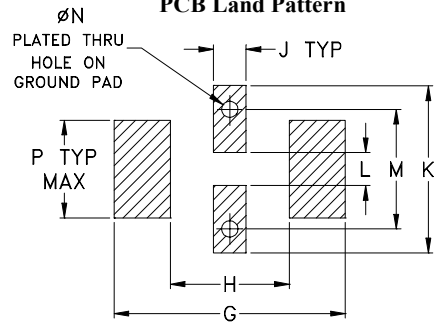

Suggested Layout,
Tolerance to be within ±.002

OUTLINE DIMENSIONS (Inches / mm)

A	B	C	D	E	F	G	H	J	K	L	M	N	P	wt
.126	.063	.037	.020	.032	.009	.169	.087	.024	.122	.024	.087	.012	.071	grams
3.20	1.60	0.94	0.51	0.81	0.23	4.29	2.21	0.61	3.10	0.61	2.21	0.30	1.80	.020

TAPE & REEL INFORMATION: F71



CERAMIC

High Pass Filter

HFCN-1910+

Mini-Circuits

TYPICAL PERFORMANCE DATA AT 25°C

Frequency (MHz)	Insertion Loss (dB)	VSWR :1
1.00	90.73	1737.18
50.00	75.59	1737.18
500.00	63.78	248.17
1040.00	50.40	72.39
1400.00	25.38	34.75
1840.00	2.89	2.89
1910.00	1.73	1.90
2050.00	0.97	1.29
2100.00	0.87	1.23
2200.00	0.75	1.18
3500.00	0.48	1.11
4400.00	0.67	1.42
4500.00	0.76	1.51
5200.00	1.37	2.19
7000.00	4.34	5.44

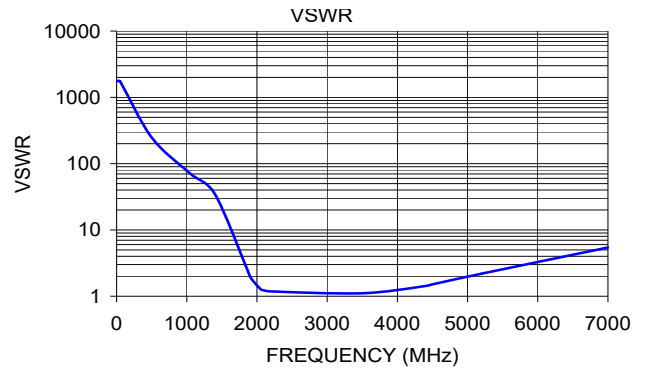
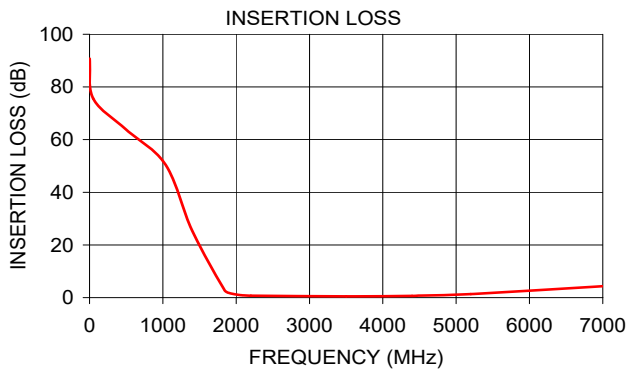

NOTES

- A. Performance and quality attributes and conditions not expressly stated in this specification document are intended to be excluded and do not form a part of this specification document.
- B. Electrical specifications and performance data contained in this specification document are based on Mini-Circuit's applicable established test performance criteria and measurement instructions.
- C. The parts covered by this specification document are subject to Mini-Circuits standard limited warranty and terms and conditions (collectively, "Standard Terms"); Purchasers of this part are entitled to the rights and benefits contained therein. For a full statement of the standard. Terms and the exclusive rights and remedies thereunder, please visit Mini-Circuits' website at www.minicircuits.com/MCLStore/terms.jsp

