

National Semiconductor is now part of  
Texas Instruments.

Search <http://www.ti.com/> for the latest technical  
information and details on our current products and services.

# ADC104S021

## 4 Channel, 50 kps to 200 kps, 10-Bit A/D Converter

### General Description

The ADC104S021 is a low-power, four-channel CMOS 10-bit analog-to-digital converter with a high-speed serial interface. Unlike the conventional practice of specifying performance at a single sample rate only, the ADC104S021 is fully specified over a sample rate range of 50 kps to 200 kps. The converter is based on a successive-approximation register architecture with an internal track-and-hold circuit. It can be configured to accept up to four input signals at inputs IN1 through IN4.

The output serial data is straight binary, and is compatible with several standards, such as SPI™, QSPI™, MICROWIRE, and many common DSP serial interfaces.

The ADC104S021 operates with a single supply, that can range from +2.7V to +5.25V. Normal power consumption using a +3V or +5V supply is 1.94 mW and 6.9 mW, respectively. The power-down feature reduces the power consumption to just 0.12  $\mu$ W using a +3V supply, or 0.47  $\mu$ W using a +5V supply.

The ADC104S021 is packaged in a 10-lead MSOP package. Operation over the industrial temperature range of  $-40^{\circ}\text{C}$  to  $+85^{\circ}\text{C}$  is guaranteed.

### Features

- Specified over a range of sample rates.
- Four input channels
- Variable power management
- Single power supply with 2.7V - 5.25V range

### Key Specifications

- DNL  $\pm 0.13$  LSB (typ)
- INL  $\pm 0.13$  LSB (typ)
- SNR 61.8 dB (typ)
- Power Consumption
  - 3V Supply 1.94 mW (typ)
  - 5V Supply 6.9 mW (typ)

### Applications

- Portable Systems
- Remote Data Acquisition
- Instrumentation and Control Systems

### Pin-Compatible Alternatives by Resolution and Speed

All devices are fully pin and function compatible.

| Resolution | Specified for Sample Rate Range of: |                |                   |
|------------|-------------------------------------|----------------|-------------------|
|            | 50 to 200 kps                       | 200 to 500 kps | 500 kps to 1 Msps |
| 12-bit     | ADC124S021                          | ADC124S051     | ADC124S101        |
| 10-bit     | <b>ADC104S021</b>                   | ADC104S051     | ADC104S101        |
| 8-bit      | ADC084S021                          | ADC084S051     | ADC084S101        |

### Connection Diagram

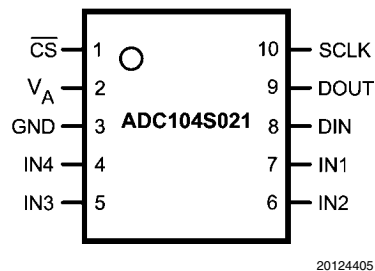

## Ordering Information

| Order Code      | Temperature Range | Description                       | Top Mark |
|-----------------|-------------------|-----------------------------------|----------|
| ADC104S021C1MM  | -40°C to +85°C    | 10-Lead MSOP Package              | X20C     |
| ADC104S021C1MMX | -40°C to +85°C    | 10-Lead MSOP Package, Tape & Reel | X20C     |
| ADC104S021EVAL  |                   | Evaluation Board                  |          |

## Block Diagram

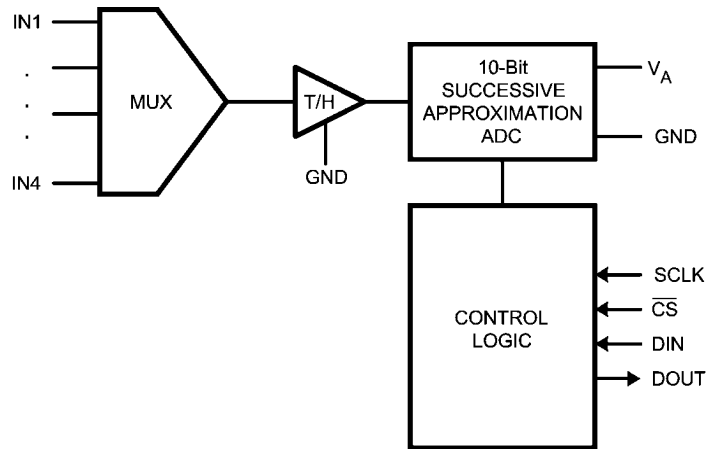

20124407

## Pin Descriptions and Equivalent Circuits

| Pin No.             | Symbol          | Description   |
|---------------------|-----------------|---|
| <b>ANALOG I/O</b>   |                 |   |
| 4-7                 | IN1 to IN4      | Analog inputs. These signals can range from 0V to $V_A$ .   |
| <b>DIGITAL I/O</b>  |                 |   |
| 10                  | SCLK            | Digital clock input. This clock directly controls the conversion and readout processes.   |
| 9                   | DOUT            | Digital data output. The output samples are clocked out of this pin on falling edges of the SCLK pin.   |
| 8                   | DIN             | Digital data input. The ADC104S021's Control Register is loaded through this pin on rising edges of the SCLK pin.   |
| 1                   | $\overline{CS}$ | Chip select. On the falling edge of $\overline{CS}$ , a conversion process begins. Conversions continue as long as $\overline{CS}$ is held low.   |
| <b>POWER SUPPLY</b> |                 |   |
| 2                   | $V_A$           | Positive supply pin. This pin should be connected to a quiet +2.7V to +5.25V source and bypassed to GND with a 1 $\mu$ F capacitor and a 0.1 $\mu$ F monolithic capacitor located within 1 cm of the power pin. |
| 3                   | GND             | The ground return for supply and signals.   |

**Absolute Maximum Ratings** (Note 1, Note 2)

2)

If Military/Aerospace specified devices are required, please contact the National Semiconductor Sales Office/Distributors for availability and specifications.

|   |                       |
|---|-----------------------|
| Supply Voltage $V_A$                          | -0.3V to 6.5V         |
| Voltage on Any Pin to GND                     | -0.3V to $V_A + 0.3V$ |
| Input Current at Any Pin (Note 3)             | $\pm 10$ mA           |
| Package Input Current (Note 3)                | $\pm 20$ mA           |
| Power Consumption at $T_A = 25^\circ\text{C}$ | See (Note 4)          |
| ESD Susceptibility (Note 5)                   |                       |
| Human Body Model                              | 2500V                 |
| Machine Model                                 | 250V                  |
| Junction Temperature                          | +150°C                |
| Storage Temperature                           | -65°C to +150°C       |

**Operating Ratings** (Note 1, Note 2)

|                                  |   |
|----------------------------------|---|
| Operating Temperature Range      | $-40^\circ\text{C} \leq T_A \leq +85^\circ\text{C}$ |
| $V_A$ Supply Voltage             | +2.7V to +5.25V                                     |
| Digital Input Pins Voltage Range | -0.3V to $V_A$                                      |
| Clock Frequency                  | 50 kHz to 16 MHz                                    |
| Analog Input Voltage             | 0V to $V_A$   |

**Package Thermal Resistance**

| Package      | $\theta_{JA}$ |
|--------------|---------------|
| 10-lead MSOP | 190°C / W     |

Soldering process must comply with National Semiconductor's Reflow Temperature Profile specifications. Refer to [www.national.com/packaging](http://www.national.com/packaging). (Note 6)

**ADC104S021 Converter Electrical Characteristics** (Note 9)

The following specifications apply for  $V_A = +2.7V$  to 5.25V, GND = 0V,  $C_L = 50$  pF,  $f_{SCLK} = 0.8$  MHz to 3.2 MHz,  $f_{SAMPLE} = 50$  kpsps to 200 kpsps, unless otherwise noted. **Boldface limits apply for  $T_A = T_{MIN}$  to  $T_{MAX}$** ; all other limits  $T_A = 25^\circ\text{C}$ .

| Symbol                                   | Parameter                                      | Conditions   | Typical    | Limits (Note 7)             | Units      |
|--|--|--|------------|-----------------------------|------------|
| <b>STATIC CONVERTER CHARACTERISTICS</b>  |  |  |            |                             |            |
|  | Resolution with No Missing Codes               |  |            | <b>10</b>                   | Bits       |
| INL                                      | Integral Non-Linearity                         |  | $\pm 0.13$ | <b>+0.3</b>                 | LSB (max)  |
|  |  |  |            | <b>-0.4</b>                 | LSB (min)  |
| DNL                                      | Differential Non-Linearity                     |  | $\pm 0.13$ | <b><math>\pm 0.4</math></b> | LSB (max)  |
| $V_{OFF}$                                | Offset Error                                   |  | +0.1       | <b><math>\pm 0.4</math></b> | LSB (max)  |
| OEM                                      | Channel to Channel Offset Error Match          |  | $\pm 0.02$ | <b><math>\pm 0.5</math></b> | LSB (max)  |
| FSE                                      | Full-Scale Error                               |  | -0.1       | <b><math>\pm 0.7</math></b> | LSB (max)  |
| FSEM                                     | Channel to Channel Full-Scale Error Match      |  | +0.02      | <b><math>\pm 0.5</math></b> | LSB (max)  |
| <b>DYNAMIC CONVERTER CHARACTERISTICS</b> |  |  |            |                             |            |
| SINAD                                    | Signal-to-Noise Plus Distortion Ratio          | $V_A = +2.7$ to 5.25V<br>$f_{IN} = 39.9$ kHz, -0.02 dBFS | 61.8       | <b>61</b>                   | dB (min)   |
| SNR                                      | Signal-to-Noise Ratio                          | $V_A = +2.7$ to 5.25V<br>$f_{IN} = 39.9$ kHz, -0.02 dBFS | 61.8       | <b>61.3</b>                 | dB (min)   |
| THD                                      | Total Harmonic Distortion                      | $V_A = +2.7$ to 5.25V<br>$f_{IN} = 39.9$ kHz, -0.02 dBFS | -86        | <b>-72</b>                  | dB (max)   |
| SFDR                                     | Spurious-Free Dynamic Range                    | $V_A = +2.7$ to 5.25V<br>$f_{IN} = 39.9$ kHz, -0.02 dBFS | 82         | <b>75</b>                   | dB (min)   |
| ENOB                                     | Effective Number of Bits                       | $V_A = +2.7$ to 5.25V<br>$f_{IN} = 39.9$ kHz, -0.02 dBFS | 9.9        | <b>9.8</b>                  | Bits (min) |
|  | Channel-to-Channel Crosstalk                   | $V_A = +5.25V$<br>$f_{IN} = 39.9$ kHz                    | -87        |                             | dB         |
| IMD                                      | Intermodulation Distortion, Second Order Terms | $V_A = +5.25V$<br>$f_a = 40.161$ kHz, $f_b = 41.015$ kHz | -82        |                             | dB         |
|  | Intermodulation Distortion, Third Order Terms  | $V_A = +5.25V$<br>$f_a = 40.161$ kHz, $f_b = 41.015$ kHz | -81        |                             | dB         |
| FPBW                                     | -3 dB Full Power Bandwidth                     | $V_A = +5V$  | 11         |                             | MHz        |
|  |  | $V_A = +3V$  | 8          |                             | MHz        |

| Symbol   | Parameter  | Conditions  | Typical                   | Limits<br>(Note 7)            | Units         |
|--|--|---|---------------------------|-------------------------------|---------------|
| <b>ANALOG INPUT CHARACTERISTICS</b>                            |  |   |                           |                               |               |
| $V_{IN}$   | Input Range  |   | 0 to $V_A$                |                               | V             |
| $I_{DCL}$  | DC Leakage Current   |   |                           | $\pm 1$                       | $\mu A$ (max) |
| $C_{INA}$  | Input Capacitance  | Track Mode  | 33                        |                               | pF            |
|  |  | Hold Mode   | 3                         |                               | pF            |
| <b>DIGITAL INPUT CHARACTERISTICS</b>                           |  |   |                           |                               |               |
| $V_{IH}$   | Input High Voltage   | $V_A = +5.25V$  |                           | <b>2.4</b>                    | V (min)       |
|  |  | $V_A = +3.6V$   |                           | <b>2.1</b>                    | V (min)       |
| $V_{IL}$   | Input Low Voltage  |   |                           | <b>0.8</b>                    | V (max)       |
| $I_{IN}$   | Input Current  | $V_{IN} = 0V$ or $V_A$  | $\pm 0.1$                 | $\pm 10$                      | $\mu A$ (max) |
| $C_{IND}$  | Digital Input Capacitance  |   | 2                         | <b>4</b>                      | pF (max)      |
| <b>DIGITAL OUTPUT CHARACTERISTICS</b>                          |  |   |                           |                               |               |
| $V_{OH}$   | Output High Voltage  | $I_{SOURCE} = 200 \mu A$  | $V_A - 0.03$              | <b><math>V_A - 0.5</math></b> | V (min)       |
|  |  | $I_{SOURCE} = 1 mA$   | $V_A - 0.1$               |                               | V             |
| $V_{OL}$   | Output Low Voltage   | $I_{SINK} = 200 \mu A$  | 0.03                      | <b>0.4</b>                    | V (max)       |
|  |  | $I_{SINK} = 1 mA$   | 0.1                       |                               | V             |
| $I_{OZH}, I_{OZL}$   | TRI-STATE® Leakage Current   |   | $\pm 0.01$                | $\pm 1$                       | $\mu A$ (max) |
| $C_{OUT}$  | TRI-STATE® Output Capacitance  |   | 2                         | <b>4</b>                      | pF (max)      |
|  | Output Coding  |   | Straight (Natural) Binary |                               |               |
| <b>POWER SUPPLY CHARACTERISTICS (<math>C_L = 10 pF</math>)</b> |  |   |                           |                               |               |
| $V_A$  | Supply Voltage   |   |                           | <b>2.7</b>                    | V (min)       |
|  |  |   |                           | <b>5.25</b>                   | V (max)       |
| $I_A$  | Supply Current, Normal Mode<br>(Operational, $\overline{CS}$ low)    | $V_A = +5.25V,$<br>$f_{SAMPLE} = 200 \text{ ksps}, f_{IN} = 40 \text{ kHz}$ | 1.3                       | <b>1.8</b>                    | mA (max)      |
|  |  | $V_A = +3.6V,$<br>$f_{SAMPLE} = 200 \text{ ksps}, f_{IN} = 40 \text{ kHz}$  | 0.55                      | <b>0.7</b>                    | mA (max)      |
|  | Supply Current, Shutdown ( $\overline{CS}$ high)                     | $V_A = +5.25V,$<br>$f_{SAMPLE} = 0 \text{ ksps}$                            | 90                        |                               | nA            |
|  |  | $V_A = +3.6V,$<br>$f_{SAMPLE} = 0 \text{ ksps}$                             | 32                        |                               | nA            |
| $P_D$  | Power Consumption, Normal Mode<br>(Operational, $\overline{CS}$ low) | $V_A = +5.25V$  | 6.9                       | <b>9.5</b>                    | mW (max)      |
|  |  | $V_A = +3.6V$   | 1.94                      | <b>2.5</b>                    | mW (max)      |
|  | Power Consumption, Shutdown ( $\overline{CS}$ high)                  | $V_A = +5.25V$  | 0.47                      |                               | $\mu W$       |
|  |  | $V_A = +3.6V$   | 0.12                      |                               | $\mu W$       |
| <b>AC ELECTRICAL CHARACTERISTICS</b>                           |  |   |                           |                               |               |
| $f_{SCLK}$   | Clock Frequency  | (Note 8)  |                           | <b>0.8</b>                    | MHz (min)     |
|  |  |   |                           | <b>3.2</b>                    | MHz (max)     |
| $f_S$  | Sample Rate  | (Note 8)  |                           | <b>50</b>                     | ksps (min)    |
|  |  |   |                           | <b>200</b>                    | ksps (max)    |
| $t_{CONV}$   | Conversion Time  |   |                           | <b>13</b>                     | SCLK cycles   |
| DC   | SCLK Duty Cycle  | $f_{SCLK} = 3.2 \text{ MHz}$  | 50                        | <b>30</b>                     | % (min)       |
|  |  |   |                           | <b>70</b>                     | % (max)       |
| $t_{ACQ}$  | Track/Hold Acquisition Time  | Full-Scale Step Input   |                           | <b>3</b>                      | SCLK cycles   |
|  | Throughput Time  | Acquisition Time + Conversion Time  |                           | <b>16</b>                     | SCLK cycles   |

## ADC104S021 Timing Specifications

The following specifications apply for  $V_A = +2.7V$  to  $5.25V$ ,  $GND = 0V$ ,  $C_L = 50$  pF,  $f_{SCLK} = 0.8$  MHz to  $3.2$  MHz,  $f_{SAMPLE} = 50$  ksp/s to  $200$  ksp/s, **Boldface limits apply for  $T_A = T_{MIN}$  to  $T_{MAX}$** ; all other limits  $T_A = 25^\circ C$ .

| Symbol    | Parameter  | Conditions     | Typical               | Limits<br>(Note 7)                      | Units     |          |
|-----------|--|----------------|-----------------------|---|-----------|----------|
| $t_{CSU}$ | Setup Time SCLK High to $\overline{CS}$ Falling Edge | (Note 10)      | $V_A = +3.0V$         | -3.5                                    | <b>10</b> | ns (min) |
|           |  |                | $V_A = +5.0V$         | -0.5                                    |           |          |
| $t_{CLH}$ | Hold time SCLK Low to $\overline{CS}$ Falling Edge   | (Note 10)      | $V_A = +3.0V$         | +4.5                                    | <b>10</b> | ns (min) |
|           |  |                | $V_A = +5.0V$         | +1.5                                    |           |          |
| $t_{EN}$  | Delay from $\overline{CS}$ Until DOUT active         |                | $V_A = +3.0V$         | +4                                      | <b>30</b> | ns (max) |
|           |  |                | $V_A = +5.0V$         | +2                                      |           |          |
| $t_{ACC}$ | Data Access Time after SCLK Falling Edge             |                | $V_A = +3.0V$         | +16.5                                   | <b>30</b> | ns (max) |
|           |  |                | $V_A = +5.0V$         | +15                                     |           |          |
| $t_{SU}$  | Data Setup Time Prior to SCLK Rising Edge            |                | +3                    | <b>10</b>                               | ns (min)  |          |
| $t_H$     | Data Valid SCLK Hold Time                            |                | +3                    | <b>10</b>                               | ns (min)  |          |
| $t_{CH}$  | SCLK High Pulse Width                                |                | $0.5 \times t_{SCLK}$ | <b><math>0.3 \times t_{SCLK}</math></b> | ns (min)  |          |
| $t_{CL}$  | SCLK Low Pulse Width                                 |                | $0.5 \times t_{SCLK}$ | <b><math>0.3 \times t_{SCLK}</math></b> | ns (min)  |          |
| $t_{DIS}$ | $\overline{CS}$ Rising Edge to DOUT High-Impedance   | Output Falling | $V_A = +3.0V$         | 1.7                                     | <b>20</b> | ns (max) |
|           |  |                | $V_A = +5.0V$         | 1.2                                     |           |          |
|           |  | Output Rising  | $V_A = +3.0V$         | 1.0                                     |           |          |
|           |  |                | $V_A = +5.0V$         | 1.0                                     |           |          |

**Note 1:** Absolute Maximum Ratings indicate limits beyond which damage to the device may occur. Operating Ratings indicate conditions for which the device is functional, but do not guarantee specific performance limits. For guaranteed specifications and test conditions, see the Electrical Characteristics. The guaranteed specifications apply only for the test conditions listed. Some performance characteristics may degrade when the device is not operated under the listed test conditions.

**Note 2:** All voltages are measured with respect to  $GND = 0V$ , unless otherwise specified.

**Note 3:** When the input voltage at any pin exceeds the power supply (that is,  $V_{IN} < GND$  or  $V_{IN} > V_A$ ), the current at that pin should be limited to 10 mA. The 20 mA maximum package input current rating limits the number of pins that can safely exceed the power supplies with an input current of 10 mA to two. The Absolute Maximum Rating specification does not apply to the  $V_A$  pin. The current into the  $V_A$  pin is limited by the Analog Supply Voltage specification.

**Note 4:** The absolute maximum junction temperature ( $T_{jmax}$ ) for this device is  $150^\circ C$ . The maximum allowable power dissipation is dictated by  $T_{jmax}$ , the junction-to-ambient thermal resistance ( $\theta_{JA}$ ), and the ambient temperature ( $T_A$ ), and can be calculated using the formula  $P_{DMAX} = (T_{jmax} - T_A)/\theta_{JA}$ . The values for maximum power dissipation listed above will be reached only when the device is operated in a severe fault condition (e.g. when input or output pins are driven beyond the power supply voltages, or the power supply polarity is reversed). Obviously, such conditions should always be avoided.

**Note 5:** Human body model is 100 pF capacitor discharged through a 1.5 k $\Omega$  resistor. Machine model is 220 pF discharged through zero ohms.

**Note 6:** Reflow temperature profiles are different for lead-free and non-lead-free packages.

**Note 7:** Tested limits are guaranteed to National's AOQL (Average Outgoing Quality Level).

**Note 8:** This is the frequency range over which the electrical performance is guaranteed. The device is functional over a wider range which is specified under Operating Ratings.

**Note 9:** Min/max specification limits are guaranteed by design, test, or statistical analysis.

**Note 10:** Clock may be either high or low when  $\overline{CS}$  is asserted as long as setup and hold times  $t_{CSU}$  and  $t_{CLH}$  are strictly observed.

# Timing Diagrams

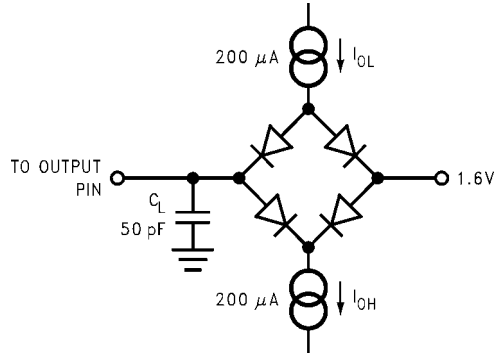

Timing Test Circuit

20124408

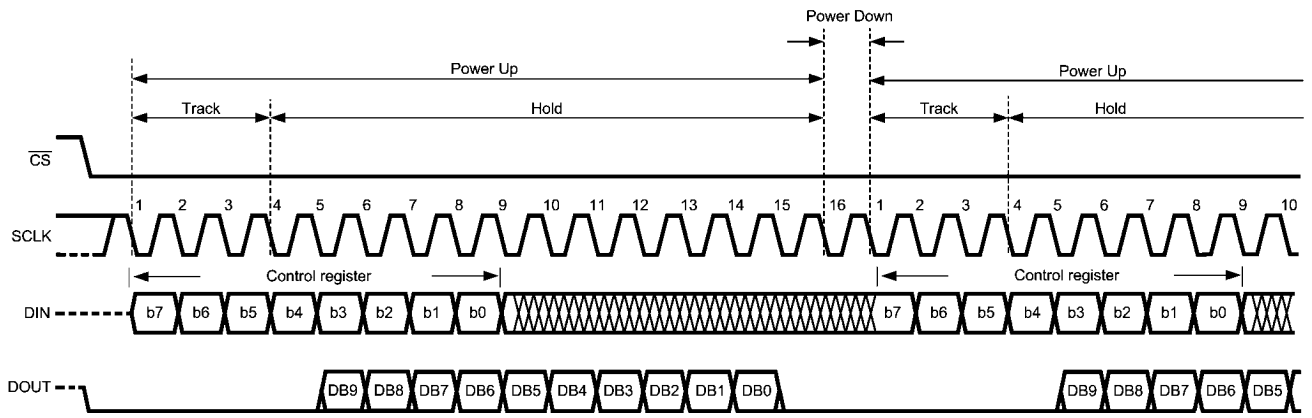

ADC104S021 Operational Timing Diagram

20124451

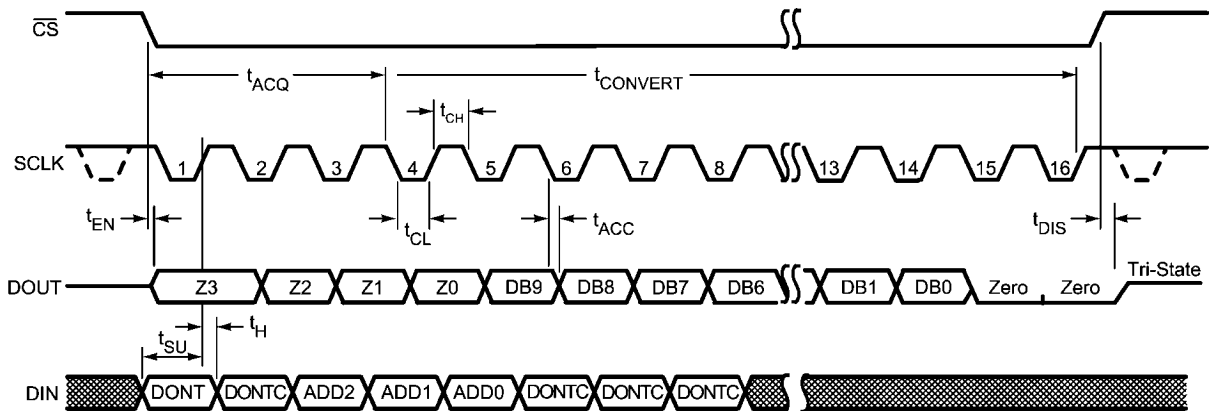

ADC104S021 Serial Timing Diagram

20124406

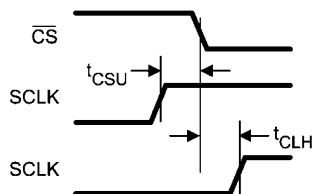

SCLK and  $\overline{\text{CS}}$  Timing Parameters

20124450

## Specification Definitions

**ACQUISITION TIME** is the time required to acquire the input voltage. That is, it is time required for the hold capacitor to charge up to the input voltage.

**APERTURE DELAY** is the time between the fourth falling SCLK edge of a conversion and the time when the input signal is acquired or held for conversion.

**CONVERSION TIME** is the time required, after the input voltage is acquired, for the ADC to convert the input voltage to a digital word.

**CROSSTALK** is the coupling of energy from one channel into the other channel, or the amount of signal energy from one analog input that appears at the measured analog input.

**DIFFERENTIAL NON-LINEARITY (DNL)** is the measure of the maximum deviation from the ideal step size of 1 LSB.

**DUTY CYCLE** is the ratio of the time that a repetitive digital waveform is high to the total time of one period. The specification here refers to the SCLK.

**EFFECTIVE NUMBER OF BITS (ENOB, or EFFECTIVE BITS)** is another method of specifying Signal-to-Noise and Distortion or SINAD. ENOB is defined as  $(\text{SINAD} - 1.76) / 6.02$  and says that the converter is equivalent to a perfect ADC of this (ENOB) number of bits.

**FULL POWER BANDWIDTH** is a measure of the frequency at which the reconstructed output fundamental drops 3 dB below its low frequency value for a full scale input.

**FULL SCALE ERROR (FSE)** is a measure of how far the last code transition is from the ideal  $1\frac{1}{2}$  LSB below  $V_{\text{REF}}$ , and is defined as:

$$V_{\text{FSE}} = V_{\text{max}} + 1.5 \text{ LSB} - V_{\text{REF}}$$

where  $V_{\text{max}}$  is the voltage at which the transition to the maximum code occurs. FSE can be expressed in Volts, LSB or percent of full scale range.

**GAIN ERROR** is the deviation of the last code transition (111...110) to (111...111) from the ideal ( $V_{\text{REF}} - 1.5 \text{ LSB}$ ), after adjusting for offset error.

**INTEGRAL NON-LINEARITY (INL)** is a measure of the deviation of each individual code from a line drawn from negative full scale ( $\frac{1}{2}$  LSB below the first code transition) through positive full scale ( $\frac{1}{2}$  LSB above the last code transition). The deviation of any given code from this straight line is measured from the center of that code value.

**INTERMODULATION DISTORTION (IMD)** is the creation of additional spectral components as a result of two sinusoidal frequencies being applied to the ADC input at the same time. It is defined as the ratio of the power in the second and third order intermodulation products to the power in one of the original frequencies. IMD is usually expressed in dB.

**MISSING CODES** are those output codes that will never appear at the ADC outputs. These codes cannot be reached with any input value. The ADC104S021 is guaranteed not to have any missing codes.

**OFFSET ERROR** is the deviation of the first code transition (000...000) to (000...001) from the ideal (i.e. GND + 0.5 LSB).

**SIGNAL TO NOISE RATIO (SNR)** is the ratio, expressed in dB, of the rms value of the input signal to the rms value of the sum of all other spectral components below one-half the sampling frequency, not including harmonics or d.c.

**SIGNAL TO NOISE PLUS DISTORTION (S/N+D or SINAD)** is the ratio, expressed in dB, of the rms value of the input signal to the rms value of all of the other spectral components below half the clock frequency, including harmonics but excluding d.c.

**SPURIOUS FREE DYNAMIC RANGE (SFDR)** is the difference, expressed in dB, between the rms values of the input signal and the peak spurious signal where a spurious signal is any signal present in the output spectrum that is not present at the input, excluding d.c.

**TOTAL HARMONIC DISTORTION (THD)** is the ratio, expressed in dB or dBc, of the rms total of the first five harmonic components at the output to the rms level of the input signal frequency as seen at the output. THD is calculated as

$$\text{THD} = 20 \cdot \log_{10} \sqrt{\frac{A_{f2}^2 + \dots + A_{f6}^2}{A_{f1}^2}}$$

where  $A_{f1}$  is the RMS power of the input frequency at the output and  $A_{f2}$  through  $A_{f6}$  are the RMS power in the first 5 harmonic frequencies.

**THROUGHPUT TIME** is the minimum time required between the start of two successive conversion. It is the acquisition time plus the conversion and read out times. In the case of the ADC104S021, this is 16 SCLK periods.



## Typical Performance Characteristics

$T_A = +25^\circ\text{C}$ ,  $f_{\text{SAMPLE}} = 50 \text{ kpsps to } 200 \text{ kpsps}$ ,  $f_{\text{SCLK}} = 0.8 \text{ MHz to } 3.2 \text{ MHz}$ ,  $f_{\text{IN}} = 39.9 \text{ kHz}$  unless otherwise stated.

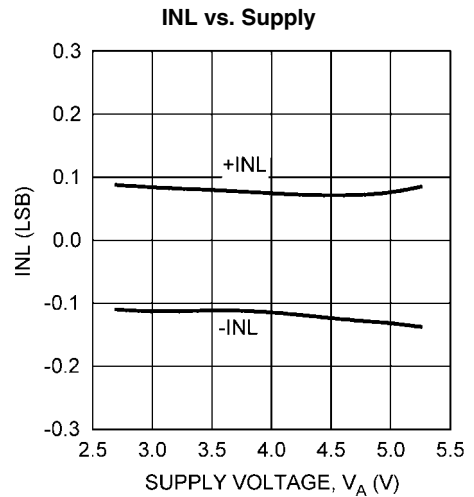
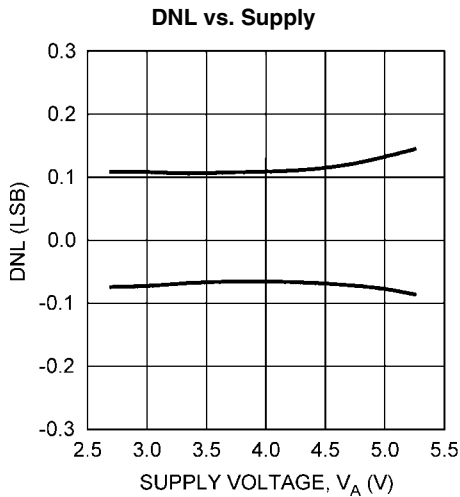
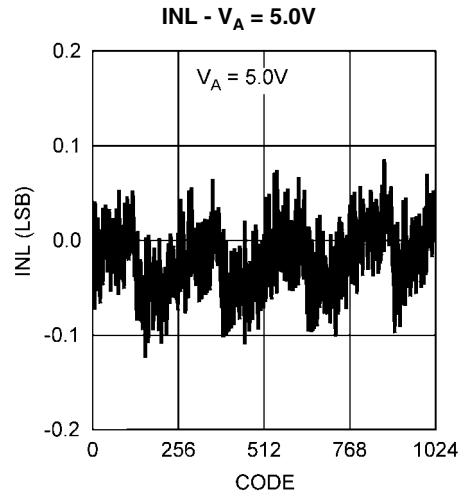
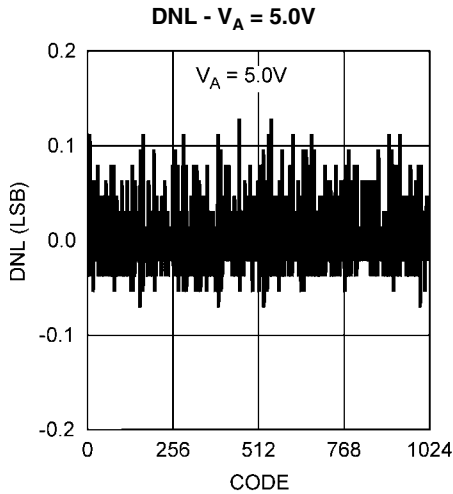
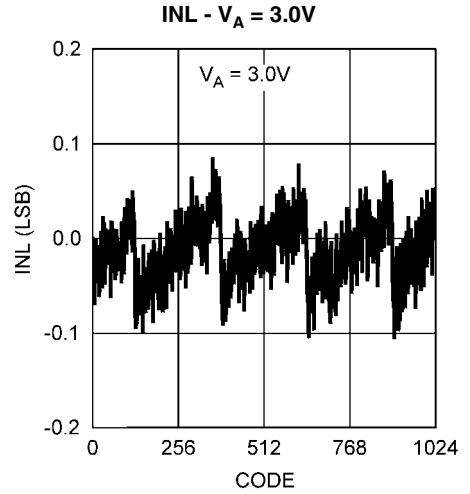
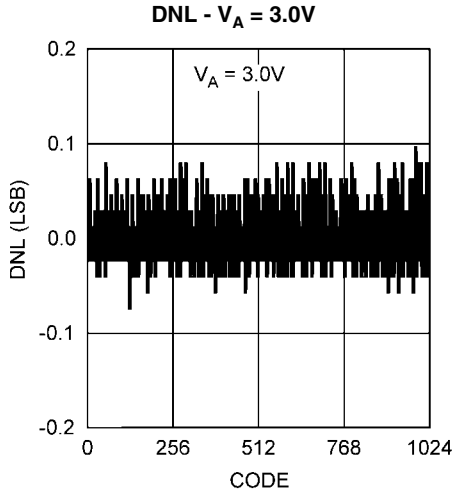

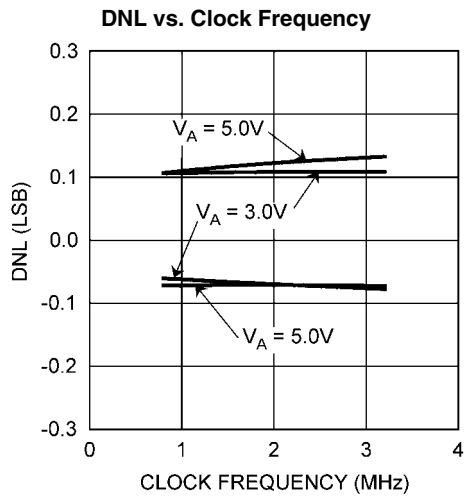

20124424

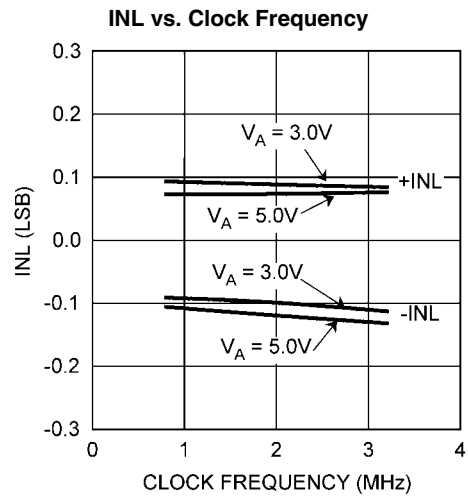

20124425

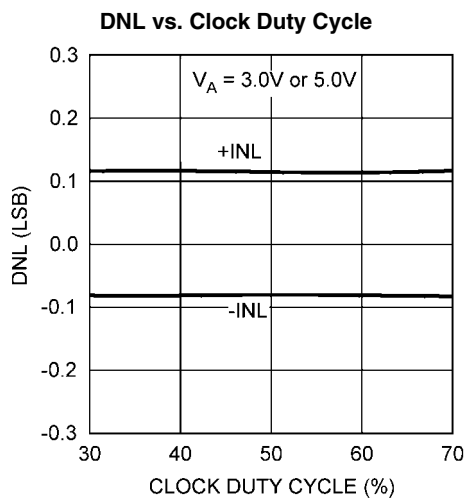

20124426

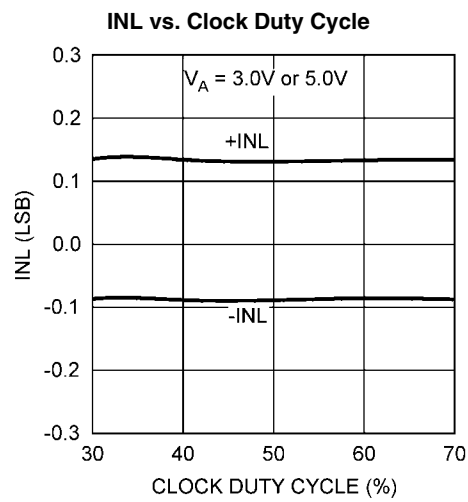

20124427

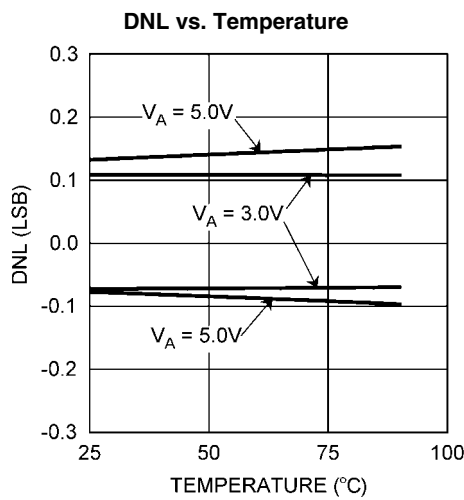

20124428

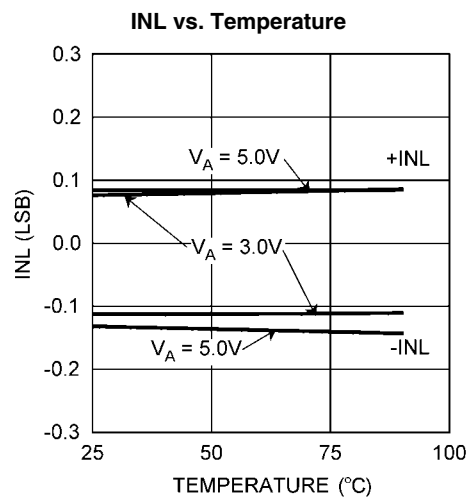

20124429

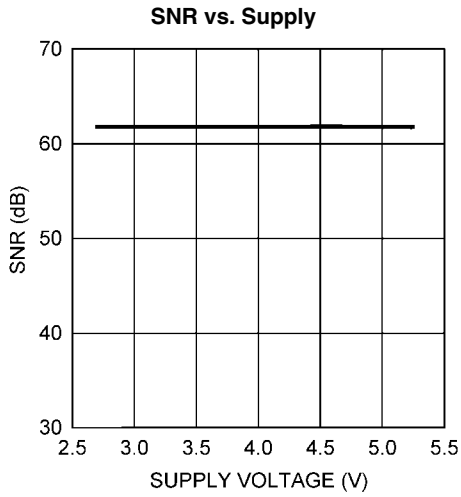

20124430

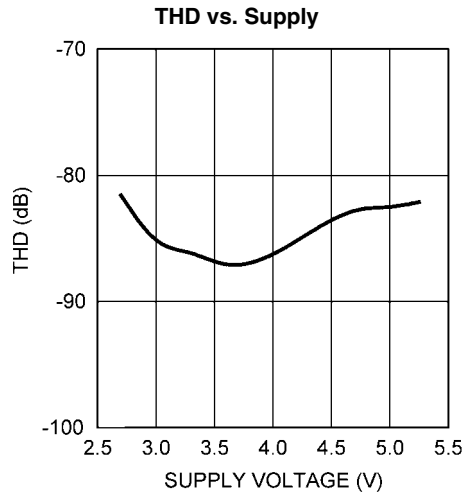

20124435

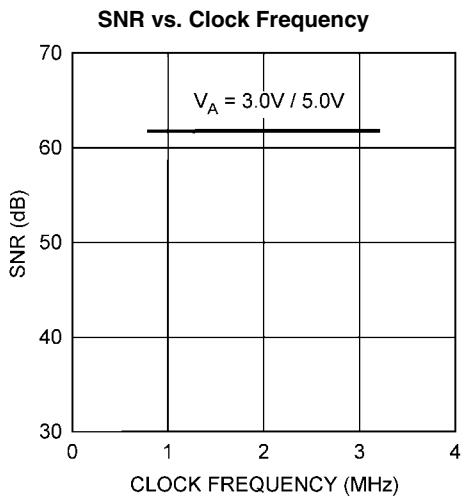

20124431

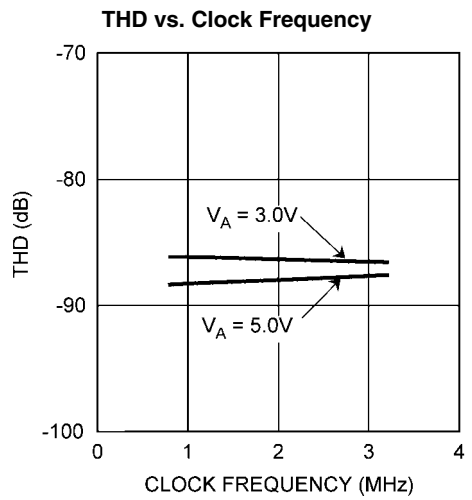

20124436

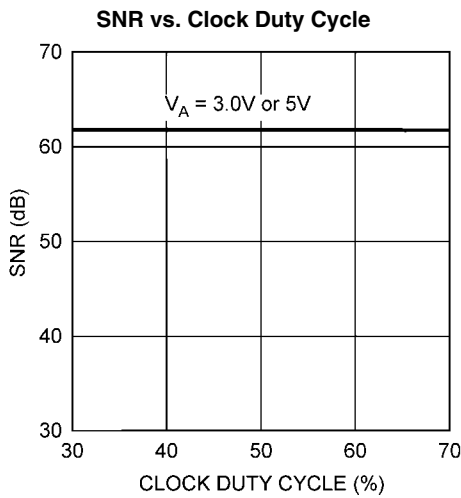

20124432

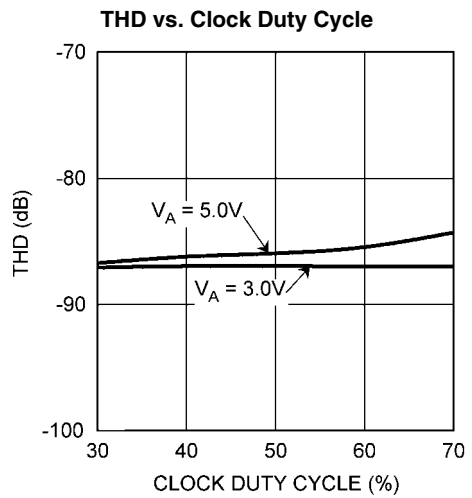

20124437

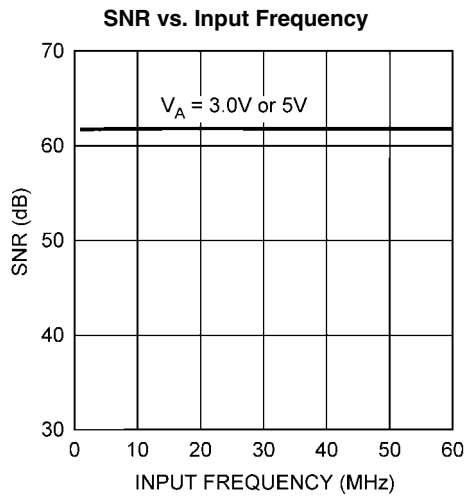

20124433

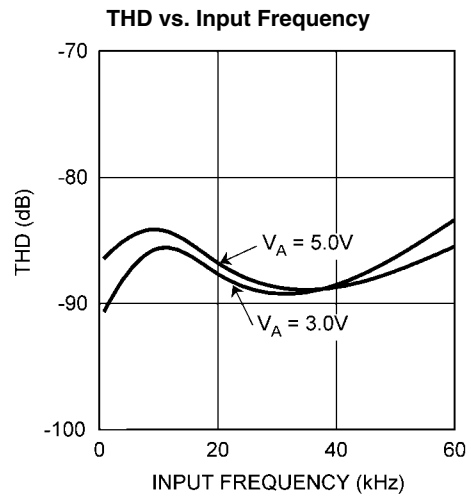

20124438

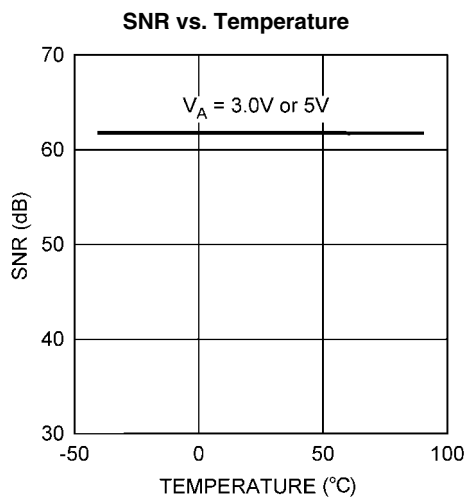

20124434

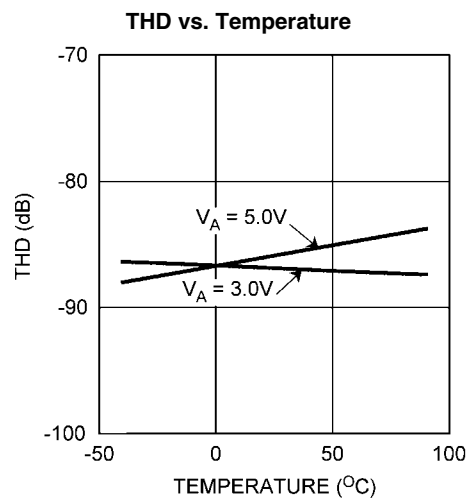

20124439

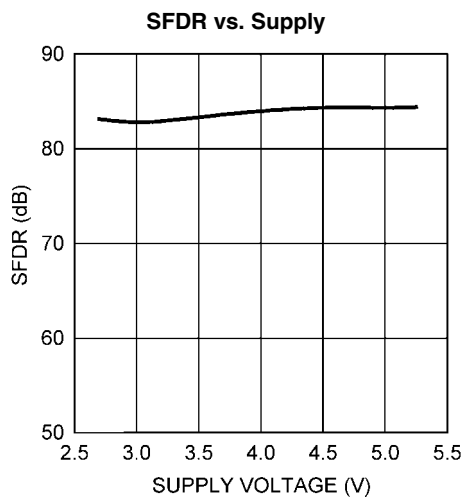

20124440

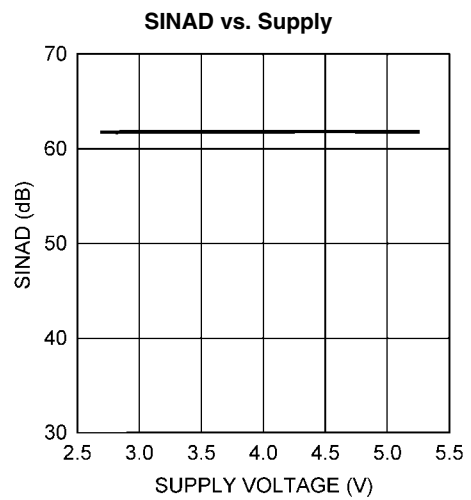

20124445

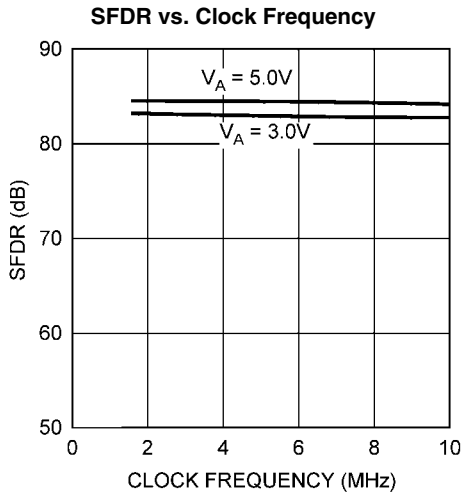

20124441

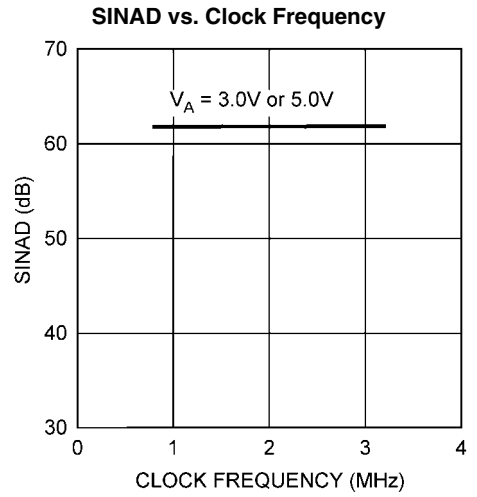

20124446

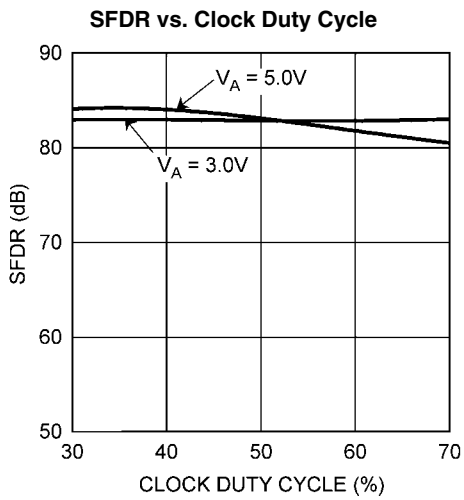

20124442

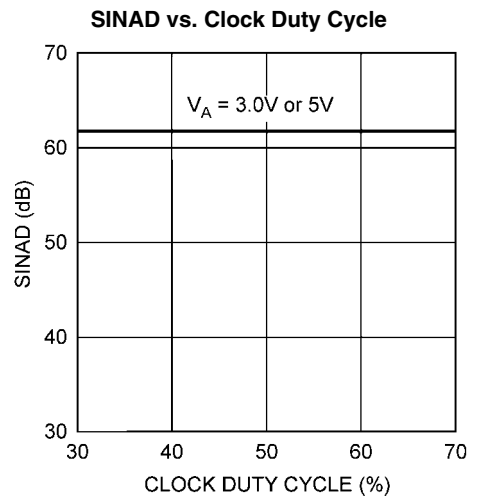

20124447

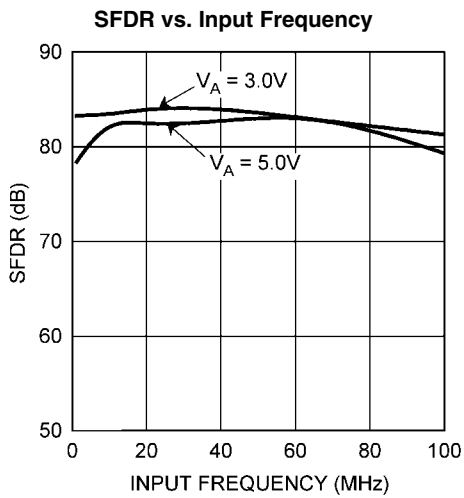

20124443

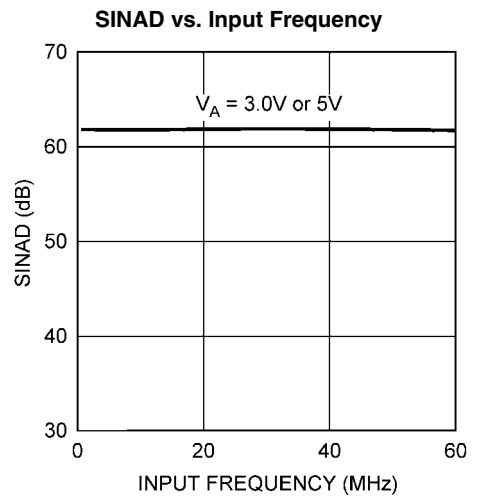

20124448

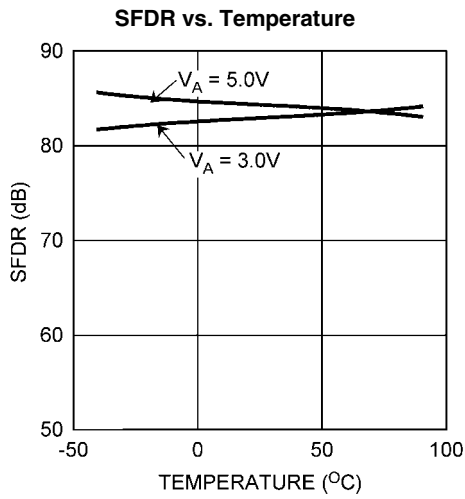

20124444

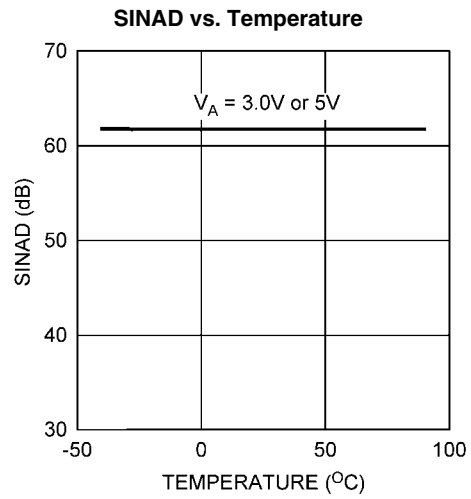

20124449

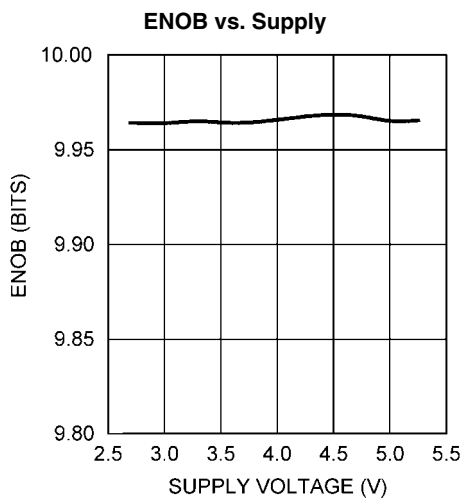

20124452

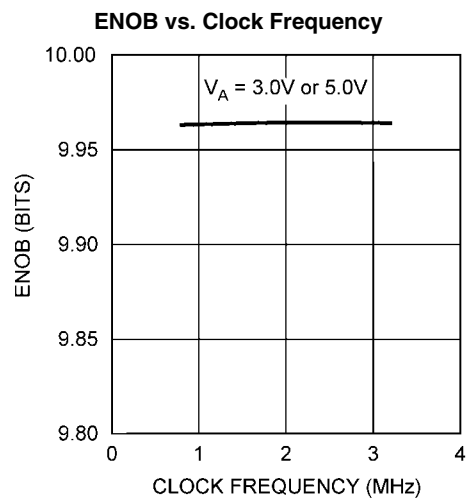

20124453

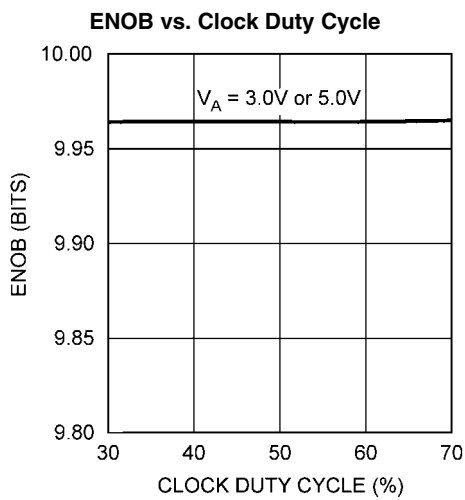

20124454

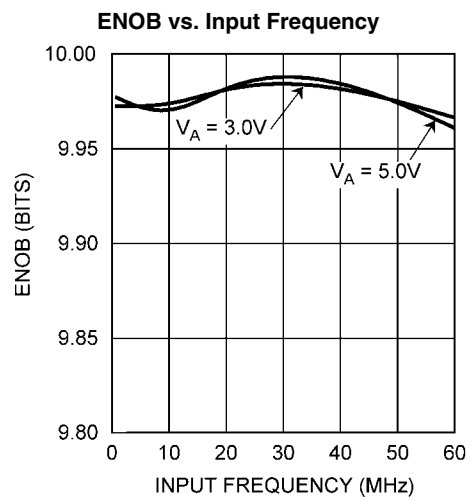

20124455

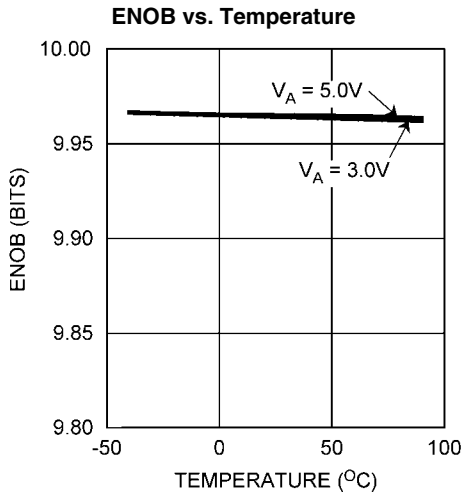

20124456

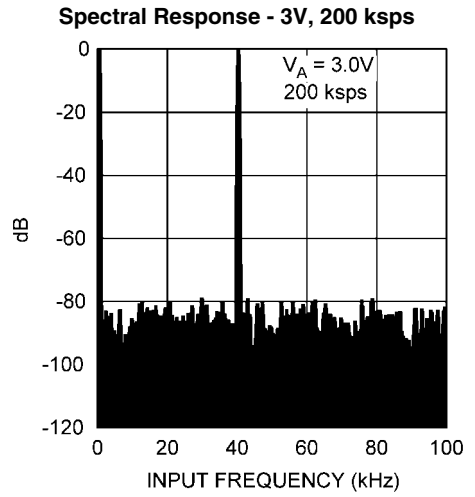

20124459

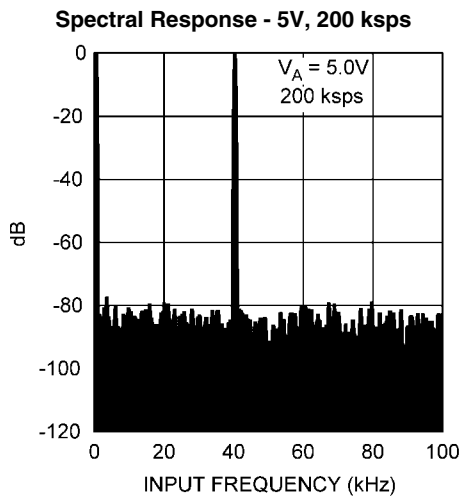

20124460

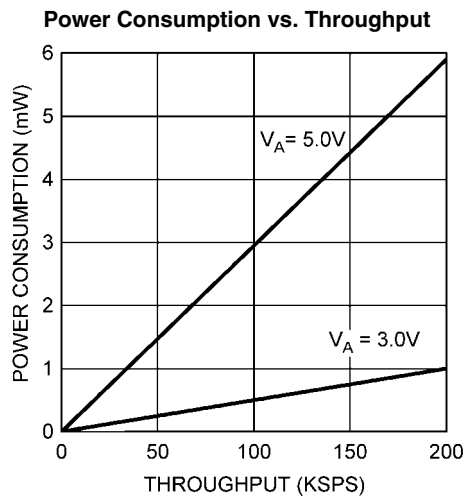

20124461

## Applications Information

### 1.0 ADC104S021 OPERATION

The ADC104S021 is a successive-approximation analog-to-digital converter designed around a charge-redistribution digital-to-analog converter. Simplified schematics of the ADC104S021 in both track and hold modes are shown in Figures 1, 2, respectively. In Figure 1, the ADC104S021 is in track mode: switch SW1 connects the sampling capacitor to one of four analog input channels through the multiplexer, and SW2 balances the comparator inputs. The ADC104S021 is in this state for the first three SCLK cycles after  $\overline{CS}$  is brought low.

Figure 2 shows the ADC104S021 in hold mode: switch SW1 connects the sampling capacitor to ground, maintaining the

sampled voltage, and switch SW2 unbalances the comparator. The control logic then instructs the charge-redistribution DAC to add fixed amounts of charge to the sampling capacitor until the comparator is balanced. When the comparator is balanced, the digital word supplied to the DAC is the digital representation of the analog input voltage. The ADC104S021 is in this state for the fourth through sixteenth SCLK cycles after  $\overline{CS}$  is brought low.

The time when  $\overline{CS}$  is low is considered a serial frame. Each of these frames should contain an integer multiple of 16 SCLK cycles, during which time a conversion is performed and clocked out at the DOUT pin and data is clocked into the DIN pin to indicate the multiplexer address for the next conversion.

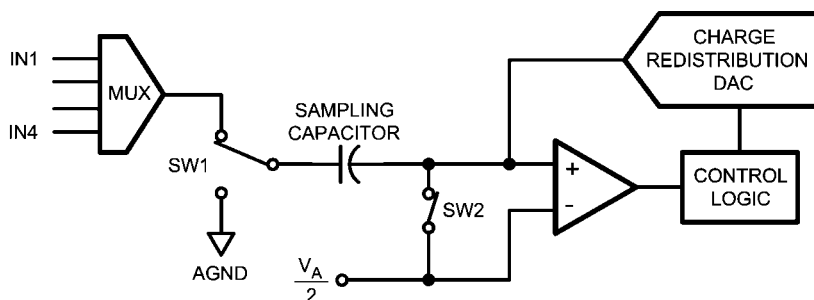

20124409

FIGURE 1. ADC104S021 in Track Mode

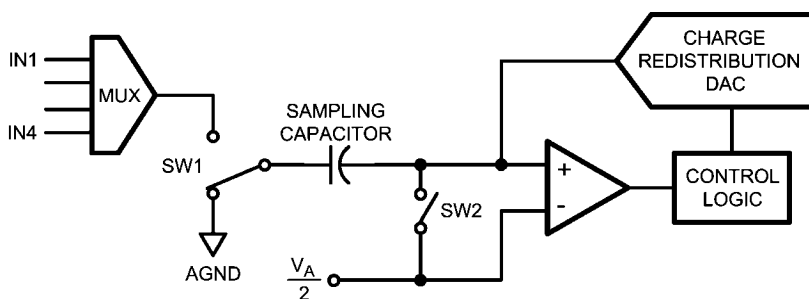

20124410

FIGURE 2. ADC104S021 in Hold Mode

### 2.0 USING THE ADC104S021

An ADC104S021 timing diagram and a serial interface timing diagram for the ADC104S021 are shown in the Timing Diagrams section.  $\overline{CS}$  is chip select, which initiates conversions and frames the serial data transfers. SCLK (serial clock) controls both the conversion process and the timing of serial data. DOUT is the serial data output pin, where a conversion result is sent as a serial data stream, MSB first. Data to be written to the ADC104S021's Control Register is placed on DIN, the serial data input pin. New data is written to the ADC at DIN with each conversion.

A serial frame is initiated on the falling edge of  $\overline{CS}$  and ends on the rising edge of  $\overline{CS}$ . Each frame must contain an integer multiple of 16 rising SCLK edges. The ADC output data (DOUT) is in a high impedance state when  $\overline{CS}$  is high and is active when  $\overline{CS}$  is low. Thus,  $\overline{CS}$  acts as an output enable.

Additionally, the device goes into a power down state when  $\overline{CS}$  is high, and also between continuous conversion cycles. During the first 3 cycles of SCLK, the ADC is in the track mode, acquiring the input voltage. For the next 13 SCLK cycles the conversion is accomplished and the data is clocked out, MSB first, starting on the 5th clock. If there is more than one conversion in a frame, the ADC will re-enter the track mode on the falling edge of SCLK after the  $N \times 16$ th rising edge of SCLK, and re-enter the hold/convert mode on the  $N \times 16 + 4$ th falling edge of SCLK, where "N" is an integer.

When  $\overline{CS}$  is brought high, SCLK is internally gated off. If SCLK is stopped in the low state while  $\overline{CS}$  is high, the subsequent fall of  $\overline{CS}$  will generate a falling edge of the internal version of SCLK, putting the ADC into the track mode. This is seen by the ADC as the first falling edge of SCLK. If SCLK is stopped with SCLK high, the ADC enters the track mode on the first falling edge of SCLK after the falling edge of  $\overline{CS}$ .



During each conversion, data is clocked into the DIN pin on the first 8 rising edges of SCLK after the fall of  $\overline{CS}$ . For each conversion, it is necessary to clock in the data indicating the input that is selected for the conversion after the current one. See Tables 1, 2 and Table 3.

If  $\overline{CS}$  and SCLK go low within the times defined by  $t_{CSU}$  and  $t_{CLH}$ , the rising edge of SCLK that begins clocking data in at DIN may be one clock cycle later than expected. It is, there-

fore, best to strictly observe the minimum  $t_{CSU}$  and  $t_{CLH}$  times given in the Timing Specifications.

There are no power-up delays or dummy conversions required with the ADC104S021. The ADC is able to sample and convert an input to full conversion immediately following power up. The first conversion result after power-up will be that of IN1.

TABLE 1. Control Register Bits

|             |       |       |       |       |       |       |       |
|-------------|-------|-------|-------|-------|-------|-------|-------|
| Bit 7 (MSB) | Bit 6 | Bit 5 | Bit 4 | Bit 3 | Bit 2 | Bit 1 | Bit 0 |
| DONTC       | DONTC | ADD2  | ADD1  | ADD0  | DONTC | DONTC | DONTC |

TABLE 2. Control Register Bit Descriptions

| Bit #:       | Symbol: | Description  |
|--------------|---------|--|
| 7 - 6, 2 - 0 | DONTC   | Don't care. The value of these bits do not affect device operation.  |
| 5            | ADD2    | These three bits determine which input channel will be sampled and converted in the next track/hold cycle. The mapping between codes and channels is shown in Table 3. |
| 4            | ADD1    |  |
| 3            | ADD0    |  |

TABLE 3. Input Channel Selection

| ADD2 | ADD1 | ADD0 | Input Channel |
|------|------|------|---------------|
| x    | 0    | 0    | IN1 (Default) |
| x    | 0    | 1    | IN2           |
| x    | 1    | 0    | IN3           |
| x    | 1    | 1    | IN4           |

3.0 ADC104S021 TRANSFER FUNCTION

The output format of the ADC104S021 is straight binary. Code transitions occur midway between successive integer LSB values. The LSB width for the ADC104S021 is  $V_A/1024$ . The ideal transfer characteristic is shown in Figure 3. The

transition from an output code of 00 0000 0000 to a code of 00 0000 0001 is at 1/2 LSB, or a voltage of  $V_A/2048$ . Other code transitions occur at steps of one LSB.

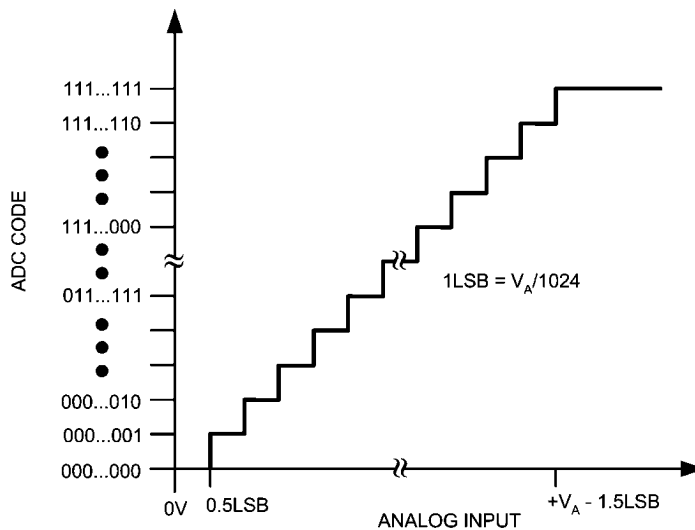

20124411

FIGURE 3. Ideal Transfer Characteristic

#### 4.0 TYPICAL APPLICATION CIRCUIT

A typical application of the ADC104S021 is shown in Figure 4. Power is provided in this example by the National Semiconductor LP2950 low-dropout voltage regulator, available in a variety of fixed and adjustable output voltages. The power supply pin is bypassed with a capacitor network located close to the ADC104S021.

Because the reference for the ADC104S021 is the supply voltage, any noise on the supply will degrade device noise

performance. To keep noise off the supply, use a dedicated linear regulator for this device, or provide sufficient decoupling from other circuitry to keep noise off the ADC104S021 supply pin. Because of the ADC104S021's low power requirements, it is also possible to use a precision reference as a power supply to maximize performance. The four-wire interface is also shown connected to a microprocessor or DSP.

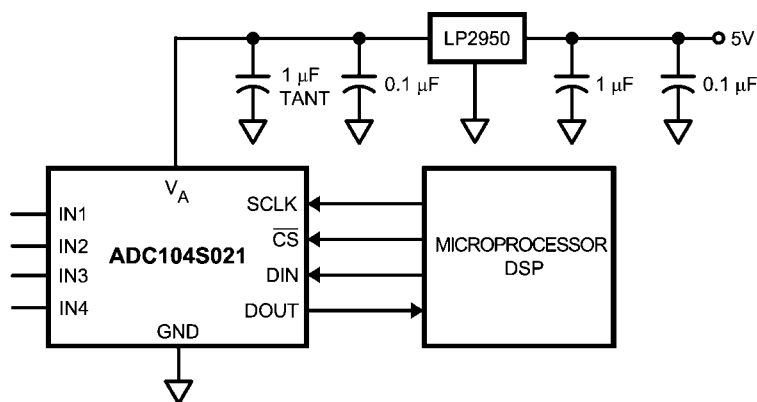

20124413

FIGURE 4. Typical Application Circuit

#### 5.0 ANALOG INPUTS

An equivalent circuit for one of the ADC104S021's input channels is shown in Figure 5. Diodes D1 and D2 provide ESD protection for the analog inputs. At no time should any input go beyond ( $V_A + 300$  mV) or ( $GND - 300$  mV), as these ESD diodes will begin conducting, which could result in erratic operation. For this reason, these ESD diodes should NOT be used to clamp the input signal.

The capacitor C1 in Figure 5 has a typical value of 3 pF, and is mainly the package pin capacitance. Resistor R1 is the on resistance of the multiplexer and track / hold switch, and is typically 500 ohms. Capacitor C2 is the ADC104S021 sampling capacitor, and is typically 30 pF. The ADC104S021 will deliver best performance when driven by a low-impedance source to eliminate distortion caused by the charging of the sampling capacitance. This is especially important when using the ADC104S021 to sample AC signals. Also important when sampling dynamic signals is a band-pass or low-pass filter to reduce harmonics and noise, improving dynamic performance.

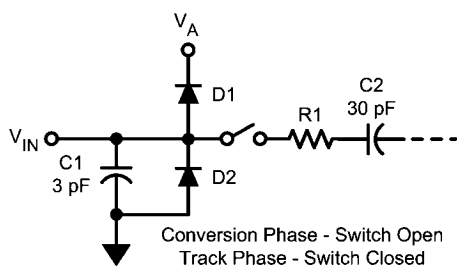

20124414

FIGURE 5. Equivalent Input Circuit

#### 6.0 DIGITAL INPUTS AND OUTPUTS

The ADC104S021's digital output DOUT is limited by, and cannot exceed, the supply voltage,  $V_A$ . The digital input pins are not prone to latch-up and, although not recommended, SCLK,  $\overline{CS}$  and DIN may be asserted before  $V_A$  without any latch-up risk.

#### 7.0 POWER SUPPLY CONSIDERATIONS

The ADC104S021 is fully powered-up whenever  $\overline{CS}$  is low, and fully powered-down whenever  $\overline{CS}$  is high, with one exception: the ADC104S021 automatically enters power-down mode between the 16th falling edge of a conversion and the 1st falling edge of the subsequent conversion (see Timing Diagrams).

The ADC104S021 can perform multiple conversions back to back; each conversion requires 16 SCLK cycles. The ADC104S021 will perform conversions continuously as long as  $\overline{CS}$  is held low.

The user may trade off throughput for power consumption by simply performing fewer conversions per unit time. The Power Consumption vs. Sample Rate curve in the Typical Performance Curves section shows the typical power consumption of the ADC104S021 versus throughput. To calculate the power consumption, simply multiply the fraction of time spent in the normal mode by the normal mode power consumption, and add the fraction of time spent in shutdown mode multiplied by the shutdown mode power dissipation.

#### 7.1 Power Management

When the ADC104S021 is operated continuously in normal mode, the maximum throughput is  $f_{SCLK}/16$ . Throughput may be traded for power consumption by running  $f_{SCLK}$  at its maximum 3.2 MHz and performing fewer conversions per unit time, putting the ADC104S021 into shutdown mode between conversions. A plot of typical power consumption versus throughput is shown in the Typical Performance Curves section. To calculate the power consumption for a given through-

put, multiply the fraction of time spent in the normal mode by the normal mode power consumption and add the fraction of time spent in shutdown mode multiplied by the shutdown mode power consumption. Generally, the user will put the part into normal mode and then put the part back into shutdown mode. Note that the curve of power consumption vs. throughput is nearly linear. This is because the power consumption in the shutdown mode is so small that it can be ignored for all practical purposes.

### 7.2 Power Supply Noise Considerations

The charging of any output load capacitance requires current from the power supply,  $V_A$ . The current pulses required from the supply to charge the output capacitance will cause voltage variations on the supply. If these variations are large enough, they could degrade SNR and SINAD performance of the ADC.

Furthermore, discharging the output capacitance when the digital output goes from a logic high to a logic low will dump current into the die substrate, which is resistive. Load discharge currents will cause "ground bounce" noise in the substrate that will degrade noise performance if that current is large enough. The larger is the output capacitance, the more current flows through the die substrate and the greater is the noise coupled into the analog channel, degrading noise performance.

To keep noise out of the power supply, keep the output load capacitance as small as practical. If the load capacitance is greater than 50 pF, use a 100  $\Omega$  series resistor at the ADC output, located as close to the ADC output pin as practical. This will limit the charge and discharge current of the output capacitance and improve noise performance.

**Physical Dimensions** inches (millimeters) unless otherwise noted

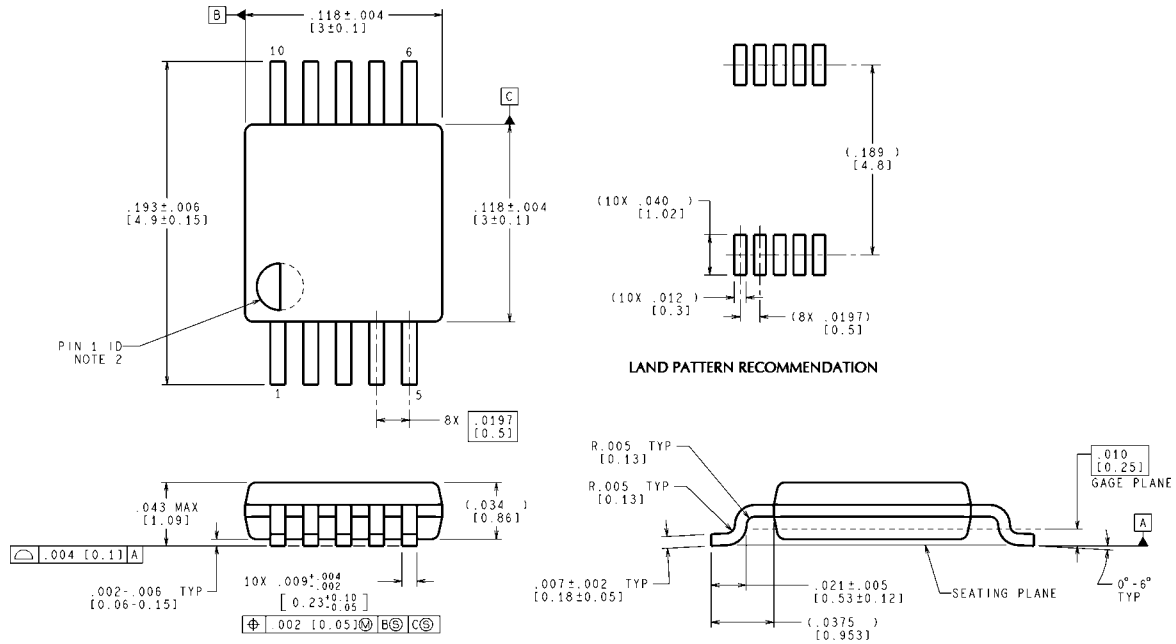

CONTROLLING DIMENSION IS INCH  
 VALUES IN [ ] ARE MILLIMETERS  
 DIMENSIONS IN ( ) FOR REFERENCE ONLY

MUB10A (Rev B)

**10-Lead MSOP**  
**Order Number ADC104S021CIMM, ADC104S021CIMMX**  
**NS Package Number P0MUB10A**

## Notes

For more National Semiconductor product information and proven design tools, visit the following Web sites at:  
[www.national.com](http://www.national.com)

| Products                       |  | Design Support               |  |
|--------------------------------|--|------------------------------|--|
| Amplifiers                     | <a href="http://www.national.com/amplifiers">www.national.com/amplifiers</a> | WEBENCH® Tools               | <a href="http://www.national.com/webench">www.national.com/webench</a>             |
| Audio                          | <a href="http://www.national.com/audio">www.national.com/audio</a>           | App Notes                    | <a href="http://www.national.com/appnotes">www.national.com/appnotes</a>           |
| Clock and Timing               | <a href="http://www.national.com/timing">www.national.com/timing</a>         | Reference Designs            | <a href="http://www.national.com/refdesigns">www.national.com/refdesigns</a>       |
| Data Converters                | <a href="http://www.national.com/adc">www.national.com/adc</a>               | Samples                      | <a href="http://www.national.com/samples">www.national.com/samples</a>             |
| Interface                      | <a href="http://www.national.com/interface">www.national.com/interface</a>   | Eval Boards                  | <a href="http://www.national.com/evalboards">www.national.com/evalboards</a>       |
| LVDS                           | <a href="http://www.national.com/lvds">www.national.com/lvds</a>             | Packaging                    | <a href="http://www.national.com/packaging">www.national.com/packaging</a>         |
| Power Management               | <a href="http://www.national.com/power">www.national.com/power</a>           | Green Compliance             | <a href="http://www.national.com/quality/green">www.national.com/quality/green</a> |
| Switching Regulators           | <a href="http://www.national.com/switchers">www.national.com/switchers</a>   | Distributors                 | <a href="http://www.national.com/contacts">www.national.com/contacts</a>           |
| LDOs                           | <a href="http://www.national.com/ldo">www.national.com/ldo</a>               | Quality and Reliability      | <a href="http://www.national.com/quality">www.national.com/quality</a>             |
| LED Lighting                   | <a href="http://www.national.com/led">www.national.com/led</a>               | Feedback/Support             | <a href="http://www.national.com/feedback">www.national.com/feedback</a>           |
| Voltage References             | <a href="http://www.national.com/vref">www.national.com/vref</a>             | Design Made Easy             | <a href="http://www.national.com/easy">www.national.com/easy</a>                   |
| PowerWise® Solutions           | <a href="http://www.national.com/powerwise">www.national.com/powerwise</a>   | Applications & Markets       | <a href="http://www.national.com/solutions">www.national.com/solutions</a>         |
| Serial Digital Interface (SDI) | <a href="http://www.national.com/sdi">www.national.com/sdi</a>               | Mil/Aero                     | <a href="http://www.national.com/milaero">www.national.com/milaero</a>             |
| Temperature Sensors            | <a href="http://www.national.com/tempensors">www.national.com/tempensors</a> | SolarMagic™                  | <a href="http://www.national.com/solarmagic">www.national.com/solarmagic</a>       |
| PLL/VCO                        | <a href="http://www.national.com/wireless">www.national.com/wireless</a>     | PowerWise® Design University | <a href="http://www.national.com/training">www.national.com/training</a>           |

THE CONTENTS OF THIS DOCUMENT ARE PROVIDED IN CONNECTION WITH NATIONAL SEMICONDUCTOR CORPORATION ("NATIONAL") PRODUCTS. NATIONAL MAKES NO REPRESENTATIONS OR WARRANTIES WITH RESPECT TO THE ACCURACY OR COMPLETENESS OF THE CONTENTS OF THIS PUBLICATION AND RESERVES THE RIGHT TO MAKE CHANGES TO SPECIFICATIONS AND PRODUCT DESCRIPTIONS AT ANY TIME WITHOUT NOTICE. NO LICENSE, WHETHER EXPRESS, IMPLIED, ARISING BY ESTOPPEL OR OTHERWISE, TO ANY INTELLECTUAL PROPERTY RIGHTS IS GRANTED BY THIS DOCUMENT.

TESTING AND OTHER QUALITY CONTROLS ARE USED TO THE EXTENT NATIONAL DEEMS NECESSARY TO SUPPORT NATIONAL'S PRODUCT WARRANTY. EXCEPT WHERE MANDATED BY GOVERNMENT REQUIREMENTS, TESTING OF ALL PARAMETERS OF EACH PRODUCT IS NOT NECESSARILY PERFORMED. NATIONAL ASSUMES NO LIABILITY FOR APPLICATIONS ASSISTANCE OR BUYER PRODUCT DESIGN. BUYERS ARE RESPONSIBLE FOR THEIR PRODUCTS AND APPLICATIONS USING NATIONAL COMPONENTS. PRIOR TO USING OR DISTRIBUTING ANY PRODUCTS THAT INCLUDE NATIONAL COMPONENTS, BUYERS SHOULD PROVIDE ADEQUATE DESIGN, TESTING AND OPERATING SAFEGUARDS.

EXCEPT AS PROVIDED IN NATIONAL'S TERMS AND CONDITIONS OF SALE FOR SUCH PRODUCTS, NATIONAL ASSUMES NO LIABILITY WHATSOEVER, AND NATIONAL DISCLAIMS ANY EXPRESS OR IMPLIED WARRANTY RELATING TO THE SALE AND/OR USE OF NATIONAL PRODUCTS INCLUDING LIABILITY OR WARRANTIES RELATING TO FITNESS FOR A PARTICULAR PURPOSE, MERCHANTABILITY, OR INFRINGEMENT OF ANY PATENT, COPYRIGHT OR OTHER INTELLECTUAL PROPERTY RIGHT.

#### LIFE SUPPORT POLICY

**NATIONAL'S PRODUCTS ARE NOT AUTHORIZED FOR USE AS CRITICAL COMPONENTS IN LIFE SUPPORT DEVICES OR SYSTEMS WITHOUT THE EXPRESS PRIOR WRITTEN APPROVAL OF THE CHIEF EXECUTIVE OFFICER AND GENERAL COUNSEL OF NATIONAL SEMICONDUCTOR CORPORATION.** As used herein:

Life support devices or systems are devices which (a) are intended for surgical implant into the body, or (b) support or sustain life and whose failure to perform when properly used in accordance with instructions for use provided in the labeling can be reasonably expected to result in a significant injury to the user. A critical component is any component in a life support device or system whose failure to perform can be reasonably expected to cause the failure of the life support device or system or to affect its safety or effectiveness.

National Semiconductor and the National Semiconductor logo are registered trademarks of National Semiconductor Corporation. All other brand or product names may be trademarks or registered trademarks of their respective holders.

Copyright© 2010 National Semiconductor Corporation

For the most current product information visit us at [www.national.com](http://www.national.com)



**National Semiconductor  
Americas Technical  
Support Center**  
Email: [support@nsc.com](mailto:support@nsc.com)  
Tel: 1-800-272-9959

**National Semiconductor Europe  
Technical Support Center**  
Email: [europe.support@nsc.com](mailto:europe.support@nsc.com)

**National Semiconductor Asia  
Pacific Technical Support Center**  
Email: [ap.support@nsc.com](mailto:ap.support@nsc.com)

**National Semiconductor Japan  
Technical Support Center**  
Email: [jpn.feedback@nsc.com](mailto:jpn.feedback@nsc.com)