

## S16LCC03-8 THRU S16LCC24-8 TVS ARRAY SERIES



### Description

The S16LCCXX-8 series of TVS array have been designed to provide bidirectional protection for sensitive electronics from damage due to voltage transients caused by electrostatic discharge (ESD), electrical fast transients (EFT), lightning and other voltage-induced transient events. The device can be used to protect combinations of 8 bidirectional lines up to 24 volts.

### Schematic & Pin Configuration

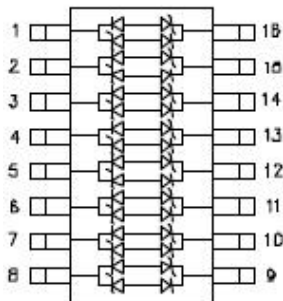

### Features

- Protects 3.3, 5, 12, 15, 24 V Components
- Bidirectional
- Low Capacitance - 25 pF
- Provides Electrically Isolated Protection
- 300 W @ 8/20 us
- Protects 8 Lines
- SO-16 Packaging
- "-A" is an AEC-Q101 qualified device
- This is a Pb - Free Device
- All SMC parts are traceable to the wafer lot
- Additional testing can be offered upon request

### Mechanical Characteristics

- SO-16 Surface Mount Package
- Approximate Weight: 0.13 grams
- PIN #1 Indicator: DOT on top of package
- Packaging: Tape and Reel Per EIA Standard 481

### Application

- RS-422, RS-423, & RS-485 Interfaces
- WAN/LAN Equipment
- Wireless Communication Circuits
- Ethernet-10/100 Base T
- Low Voltage ASICs

### Absolute Maximum Ratings:

Parameter	Symbol	Value	Units
Peak Pulse Power, 8/20 $\mu$ s Wave shape	P	300	W
Operating Temperature	T <sub>J</sub>	-55 to +125	°C
Storage Temperature	T <sub>stg</sub>	-55 to +150	°C
Lead Soldering Temperature	T <sub>L</sub>	260 (10 Sec.)	°C

### Electrical Characteristics@25°C

Part Number	Stand-off Voltage $V_{wm}$ (V) Max	Breakdown Voltage $V_{BR}$ @1mA (V) Min	Clamping Voltage $V_c$ @ 1 A (V) Max	Leakage Current $I_R$ @ $V_{wm}$ ( $\mu$ A) Max	Capacitance (f = 1MHz) C @ 0V (pF) Max	Temperature Coefficient of $V_{BR}$ a( $V_{BR}$ ) mv/°C Max
S16LCC03-8	3.3	4	7	200	25	-5
S16LCC05-8	5.0	6	9.8	20	25	1
S16LCC12-8	12.0	13.3	19	1	25	8
S16LCC15-8	15.0	16.7	24	1	25	11
S16LCC24-8	24.0	26.7	43	1	25	28

### Ratings and Characteristics Curves

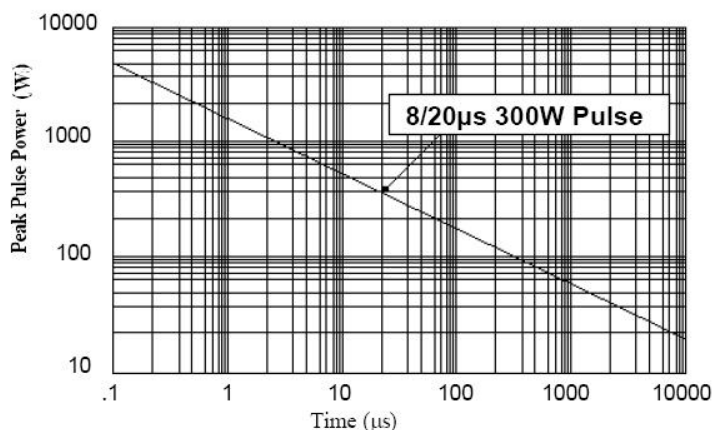

Figure 1. Peak Pulse Power Vs Pulse Time ( $\mu$ s)

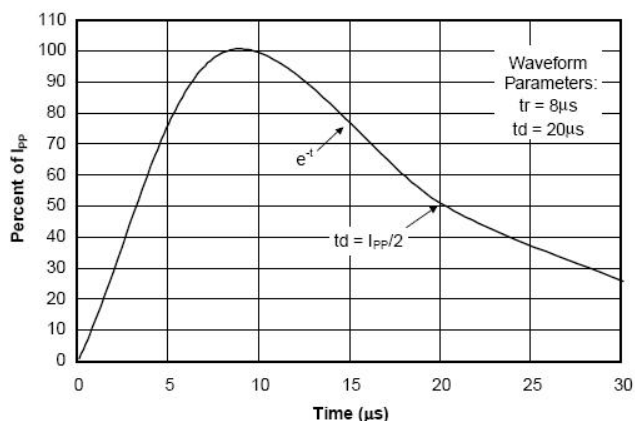

Figure 2. Pulse Wave Form

### Ordering Information

Device	Package	Shipping
S16LCC03-8 THRU S16LCC24-8	SO-16 (Pb-Free)	2500pcs / reel
S16LCC03-8TR THRU S16LCC24-8TR	SO-16 (Pb-Free)	2500pcs / reel

For information on tape and reel specifications, including part orientation and tape sizes, please refer to our tape and reel packaging specification.

### Marking Diagram

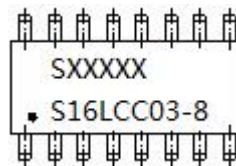

Where XXXXX is YYWWL

S16LCC03-8 = Part Name  
S = S  
YY = Year  
WW = Week  
L = Lot Number

Cautions: Molding resin  
Epoxy resin UL:94V-0

## Circuit Diagram

Ideal for RS-485 applications, the S16LCCxx-8 Series provides up to eight (8) lines of protection in a common-mode configuration as depicted in Figure 1. This low capacitance series allows the transceiver or telecommunications circuit to operate safely without significant signal distortion.

Circuit connectivity is as follows:

- ✓ Lines 1 is connected to Pin 9.
- ✓ Line 2 is connected to Pin 10.
- ✓ Line 3 is connected to Pin 11.
- ✓ Line 4 is connected to Pin 12.
- ✓ Line 5 is connected to Pin 13.
- ✓ Line 6 is connected to Pin 14.
- ✓ Line 7 is connected to Pin 15.
- ✓ Line 8 is connected to Pin 16.
- ✓ Pins 1-8 are connected to ground.

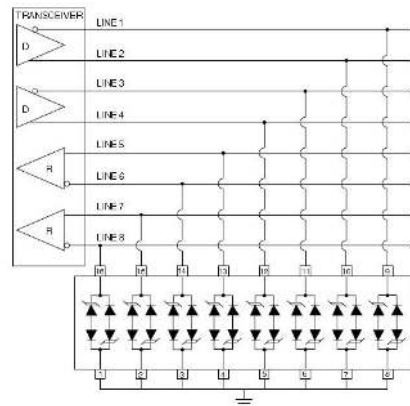

## Mechanical Dimensions SO-16

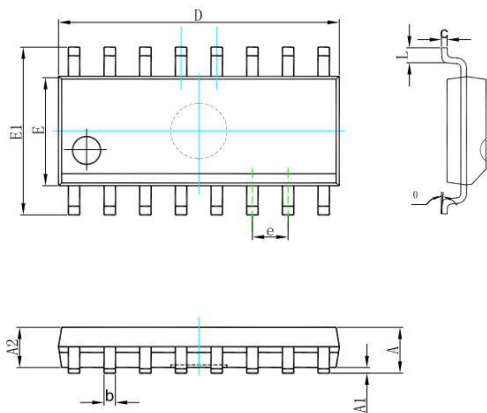

SYMBOL	Millimeters		Inches	
	MIN.	MAX.	MIN.	MAX.
A	1.350	1.800	0.053	0.708
A1	0.050	0.250	0.002	0.010
A2	1.350	1.650	0.053	0.065
b	0.330	0.510	0.013	0.020
c	0.153	0.250	0.006	0.010
D	9.700	10.200	0.382	0.402
E	3.800	4.150	0.150	0.163
E1	5.700	6.300	0.224	0.248
e	1.14	1.40	0.045	0.055
L	0.400	1.270	0.016	0.050
θ	0°	8°	0°	8°

## Carrier Tape Specification SO-16

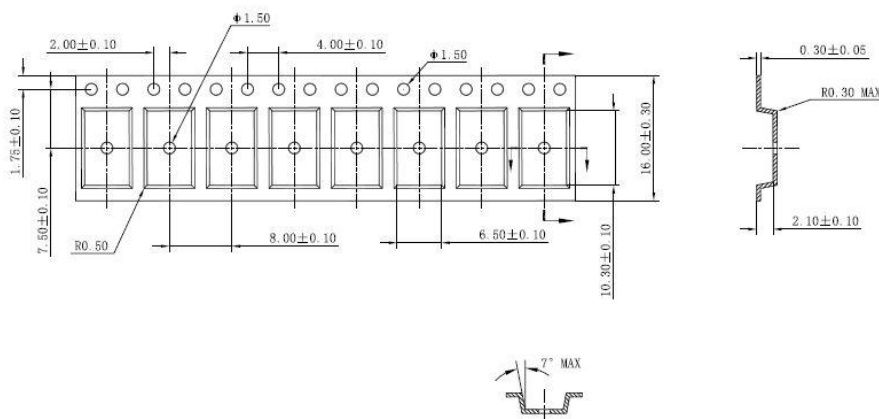

**Technical Data**  
**Data Sheet NO290, Rev. A**



**DISCLAIMER:**

- 1- The information given herein, including the specifications and dimensions, is subject to change without prior notice to improve product characteristics. Before ordering, purchasers are advised to contact the SMC Diode Solutions sales department for the latest version of the datasheet(s).
- 2- In cases where extremely high reliability is required (such as use in nuclear power control, aerospace and aviation, traffic equipment, medical equipment, and safety equipment), safety should be ensured by using semiconductor devices that feature assured safety or by means of users' fail-safe precautions or other arrangement.
- 3- In no event shall SMC Diode Solutions be liable for any damages that may result from an accident or any other cause during operation of the user's units according to the datasheet(s). SMC Diode Solution assumes no responsibility for any intellectual property claims or any other problems that may result from applications of information, products or circuits described in the datasheets.
- 4- In no event shall SMC Diode Solutions be liable for any failure in a semiconductor device or any secondary damage resulting from use at a value exceeding the absolute maximum rating.
- 5- No license is granted by the datasheet(s) under any patents or other rights of any third party or SMC Diode Solutions.
- 6- The datasheet(s) may not be reproduced or duplicated, in any form, in whole or part, without the expressed written permission of SMC Diode Solutions.
- 7- The products (technologies) described in the datasheet(s) are not to be provided to any party whose purpose in their application will hinder maintenance of international peace and safety nor are they to be applied to that purpose by their direct purchasers or any third party. When exporting these products (technologies), the necessary procedures are to be taken in accordance with related laws and regulations..