

**Chip Ferrite Bead****BLM02B□□□□SN1□****Reference Specification****1.Scope**

This reference specification applies to Chip Ferrite Bead BLM02BB/BC\_SN Series.

**2.Part Numbering**(ex.)  $\frac{BL}{(1)} \frac{M}{(2)} \frac{02}{(3)} \frac{BC}{(4)} \frac{220}{(5)} \frac{S}{(6)} \frac{N}{(7)} \frac{1}{(8)} \frac{D}{(9)}$ (1)Product ID (2)Type (3)Dimension(L×W) (4)Characteristics (5)Typical Impedance at 100MHz  
(6)Performance (7)Category (8)Numbers of Circuit (9)Packaging(D:Taping / B:Bulk)**3.Rating**

Customer Part Number	MURATA Part Number	Impedance (Ω) (at 100MHz, Under Standard Testing Condition)			Rated Current (mA)	DC Resistance (Ω max.)		Remark
		at 100MHz	at 1GHz	at 2GHz		Initial Values	Values After Testing	
	BLM02BB101SN1D	100±25%	—	—	125	2.0	2.05	For High speed Signal line
	BLM02BB101SN1B							
	BLM02BC100SN1D	10±5	95±50%	140±50%	250	0.5	0.6	
	BLM02BC100SN1B							
	BLM02BC220SN1D	22±25%	240±40%	340±40%	200	0.9	1.0	
	BLM02BC220SN1B							

■ Operating Temperature : -55°C to +125°C

■ Storage Temperature : -55°C to +125°C

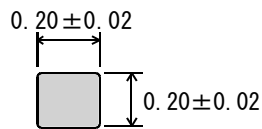
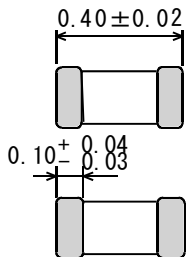
**4.Style and Dimensions**

□ : Electrode

(in mm)

## ■ Equivalent Circuit



( Resistance element becomes dominant at high frequencies. )

■ Unit Mass (Typical value)  
0.08mg**5.Marking**

No marking.

**6.Standard Testing Conditions**

&lt; Unless otherwise specified &gt;

Temperature : Ordinary Temp. (15 °C to 35 °C)

Humidity : Ordinary Humidity (25%(RH) to 85%(RH))

&lt; In case of doubt &gt;

Temperature : 20°C±2 °C

Humidity : 60%(RH) to 70%(RH)

Atmospheric pressure : 86kPa to 106kPa

**7.Specifications****7-1.Electrical Performance**

No.	Item	Specification	Test Method
7-1-1	Impedance	Meet item 3.	Measuring Frequency : 100MHz±1MHz, 1GHz±1MHz 2GHz±1MHz Measuring Equipment : KEYSIGHT4291A or the equivalent Test Fixture : KEYSIGHT 16197A or the equivalent
7-1-2	DC Resistance	Meet item 3.	Measuring Equipment : Digital multi meter * Except resistance of the Substrate and Wire

**7-2.Mechanical Performance**

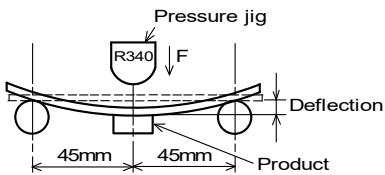
No.	Item	Specification	Test Method						
7-2-1	Appearance and Dimensions	Meet item 4.	Visual Inspection and measured with Measuring Microscope.						
7-2-2	Bending Strength	Meet Table 1.  Table 1 <table border="1"> <tr> <td>Appearance</td> <td>No damage</td> </tr> <tr> <td>Impedance Change (at 100MHz)</td> <td>Within <math>\pm 30\%</math></td> </tr> <tr> <td>DC Resistance</td> <td>Meet item 3.</td> </tr> </table>	Appearance	No damage	Impedance Change (at 100MHz)	Within $\pm 30\%$	DC Resistance	Meet item 3.	It shall be soldered on the Glass-epoxy substrate. Substrate : 100mm $\times$ 40mm $\times$ 0.8mm Deflection : 1.0mm Speed of Applying Force : 0.5mm/s Keeping Time : 30s  
Appearance	No damage								
Impedance Change (at 100MHz)	Within $\pm 30\%$								
DC Resistance	Meet item 3.								
7-2-3	Vibration		It shall be soldered on the substrate. Oscillation Frequency : 10Hz to 2000Hz to 10Hz for 20 min Amplitude : Total Amplitude 1.5mm or Acceleration amplitude 196m/s <sup>2</sup> whichever is smaller. Testing Time : A period of 2 hours in each of 3 mutually perpendicular directions. (Total 6 h)						
7-2-4	Resistance to Soldering Heat (Reflow)		Pre-Heating : 150°C~180°C, 90s $\pm$ 30s Solder : Sn-3.0Ag-0.5Cu Heating:above 230°C,60s Peak temperature:260°C,10s Cycle of reflow:2 times Then measured after exposure in the room condition for 48h $\pm$ 4h.						
7-2-5	Solderability	The electrodes shall be at least 95% covered with new solder coating.	Flux : Ethanol solution of rosin,25(wt)% Pre-Heating : 150°C $\pm$ 10°C, 60s~90s Solder : Sn-3.0Ag-0.5Cu Solder Temperature : 240°C $\pm$ 5°C Immersion Time : 3s $\pm$ 1s Immersion and emersion rates : 25mm/s						

**7-3.Environmental Performance**

It shall be soldered on the substrate.

No.	Item	Specification	Test Method
7-3-1	Temperature Cycle	Meet Table 1.	1 cycle : 1 step : -55 °C(+0 °C,-3 °C) / 30min $\pm$ 3min 2 step : Ordinary temp. / 10min to 15min 3 step : +125 °C(+3 °C,-0 °C) / 30min $\pm$ 3min 4 step : Ordinary temp. / 10min to 15min Total of 100 cycles Then measured after exposure in the room condition for 48h $\pm$ 4h.
7-3-2	Humidity		Temperature : 70°C $\pm$ 2°C Humidity : 90%(RH) to 95%(RH) Time : 1000h(+48h,-0h) Then measured after exposure in the room condition for 48h $\pm$ 4h.
7-3-3	Heat Life		Temperature : 125°C $\pm$ 3°C Applying Current : Rated Current Time : 1000h(+48h,-0h) Then measured after exposure in the room condition for 48h $\pm$ 4h.
7-3-4	Cold Resistance		Temperature : -55 $\pm$ 2°C Time : 1000h(+48h,-0h) Then measured after exposure in the room condition for 48h $\pm$ 4h.



(6)Dimensions of reel and taping(leader-tape, trailer-tape)

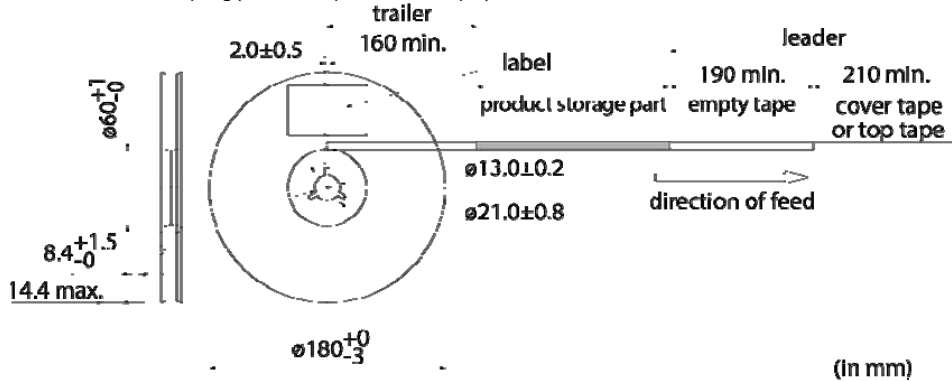

**8-4. Specification of Outer Case**

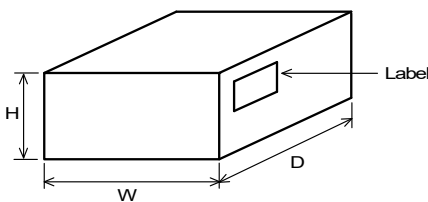

Outer Case Dimensions (mm)			Standard Reel Quantity in Outer Case (Reel)
W	D	H	
186	186	93	5

\* Above Outer Case size is typical. It depends on a quantity of an order.

**9. ⚠ Caution**

**9-1.Surge current**

Excessive surge current (pulse current or rush current) than specified rated current applied to the product may cause a critical failure, such as an open circuit, burnout caused by excessive temperature rise. Please contact us in advance in case of applying the surge current.

**9-2.Limitation of Applications**

Please contact us before using our products for the applications listed below which require especially high reliability for the prevention of defects which might directly cause damage to the third party's life, body or property.

- (1)Aircraft equipment
- (2)Aerospace equipment
- (3)Undersea equipment
- (4)Power plant control equipment
- (5)Medical equipment
- (6)Disaster prevention / crime prevention equipment
- (7)Traffic signal equipment
- (8)Transportation equipment (vehicles, trains, ships, etc.)
- (9) Data-processing equipment
- (10)Applications of similar complexity and /or reliability requirements to the applications listed in the above

**9-3. Corrosive gas**

Please refrain from use since contact with environments with corrosive gases (sulfur gas [hydrogen sulfide, sulfur dioxide, etc.], chlorine, ammonia, etc.) or oils (cutting oil, silicone oil, etc.) that have come into contact with the previously stated corrosive gas environment will result in deterioration of product quality or an open from deterioration due to corrosion of product electrode, etc. We will not bear any responsibility for use under these environments.

**10. Notice**

Products can only be soldered with reflow.  
 This product is designed for solder mounting.  
 Please consult us in advance for applying other mounting method such as conductive adhesive.

**10-1.Land pattern designing**

- Standard land dimensions (Reflow soldering)

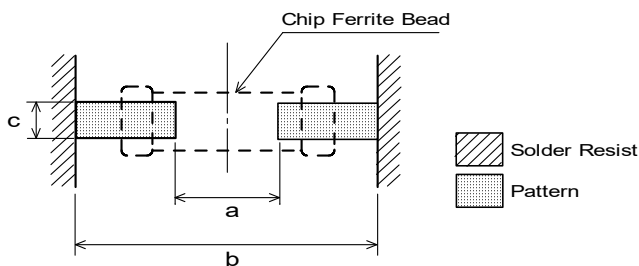

a	b	c
0.18	0.48	0.215

(in mm)

**10-2. Mounting Conditions**

- Please check the mounting condition before using.
- Using mounting conditions (nozzles, equipment conditions, etc.) that are not suitable for products may lead to pick up errors, misalignment, or damage to the product.

**10-3.Soldering Conditions**

## (1) Flux,Solder

Flux	Use rosin-based flux, but not highly acidic flux (with chlorine content exceeding 0.2(wt)% . ) Do not use water-soluble flux.
Solder	Use Sn-3.0Ag-0.5Cu solder Standard thickness of solder paste : 50 μm to 80 μm

## (2) Soldering conditions

- Pre-heating should be in such a way that the temperature difference between solder and ferrite surface is limited to 150°C max. Also cooling into solvent after soldering should be in such a way that the temperature difference is limited to 100°C max.

Insufficient pre-heating may cause cracks on the ferrite, resulting in the deterioration of product quality.

- Standard soldering profile and the limit soldering profile is as follows.

The excessive limit soldering conditions may cause leaching of the electrode and / or resulting in the deterioration of product quality.

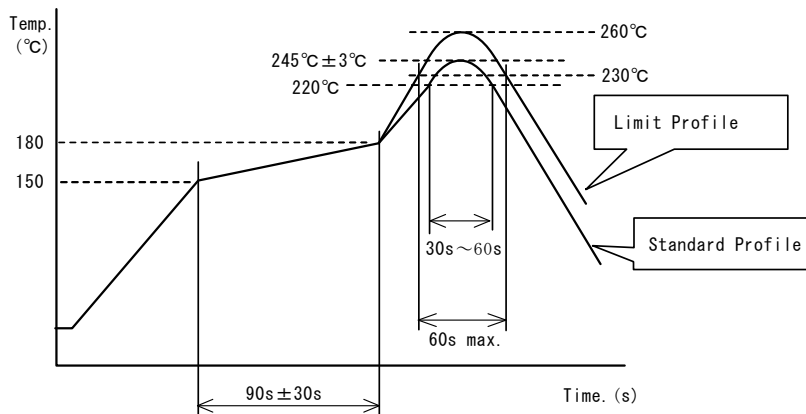

	Standard Profile	Limit Profile
Pre-heating	150~180°C 、 90s±30s	
Heating	above 220°C、 30s~60s	above 230°C、 60s max.
Peak temperature	245±3°C	260°C,10s
Cycle of reflow	2 times	2 times

**10-4.Solder Volume**

Solder shall be used not to be exceed as shown below.

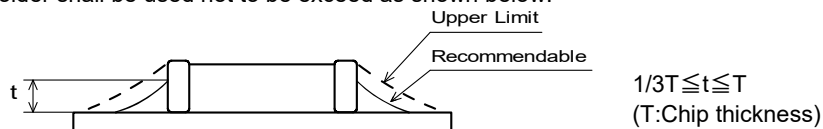

Accordingly increasing the solder volume, the mechanical stress to product is also increased. Exceeding solder volume may cause the failure of mechanical or electrical performance.

**10-5.Attention regarding P.C.B. bending**

The following shall be considered when designing and laying out P.C.B.'s.

- (1) P.C.B. shall be designed so that products are not subject to the mechanical stress for board warpage.  
<Products direction>

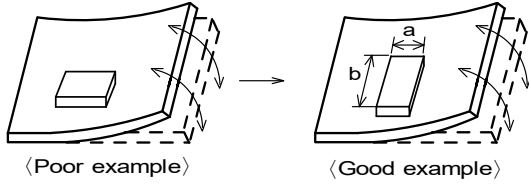

Products shall be located in the sideways direction (Length:a<b) to the mechanical stress.

- (2)Components location on P.C.B. separation.

It is effective to implement the following measures, to reduce stress in separating the board.

It is best to implement all of the following three measures; however, implement as many measures as possible to reduce stress.

Contents of Measures	Stress Level
(1) Turn the mounting direction of the component parallel to the board separation surface.	A > D *1
(2) Add slits in the board separation part.	A > B
(3) Keep the mounting position of the component away from the board separation surface.	A > C

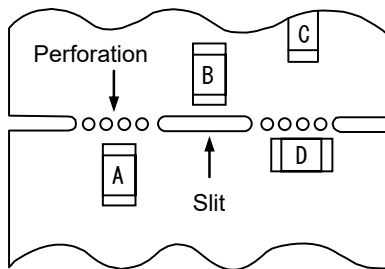

\*1 A > D is valid when stress is added vertically to the perforation as with Hand Separation. If a Cutting Disc is used, stress will be diagonal to the PCB, therefore A > D is invalid.

- (3) Mounting Components Near Screw Holes

When a component is mounted near a screw hole, it may be affected by the board deflection that occurs during the tightening of the screw. Mount the component in a position as far away from the screw holes as possible.

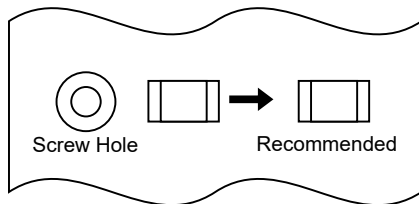

**10-6.Mounting density**

Add special attention to radiating heat of products when mounting the inductor near the products with heating. The excessive heat by other products may cause deterioration at joint of this product with substrate.

**10-7. Cleaning**

When cleaning this product, observe the following conditions.

Any cleaning may cause deterioration in the quality of the product, so please check the quality of this product before use.

- (1) The cleaning temperature shall be 60°C max. If isopropyl alcohol (IPA) is used, the cleaning temperature shall be 40°C max.
- (2) When ultrasonic cleaning is used, under some cleaning conditions, the substrate could resonate and the substrate vibrations could result in chip cracks, solder breakage, and other problems. Be sure to always perform a test cleaning beforehand using an actual cleaning device, and then check the quality of the products.

**(3) Cleaner**

Alcohol-based cleaner: IPA

Aqueous agent: PINE ALPHA ST-100S

- (4) There shall be no residual flux or residual cleaner.

When using aqueous agent, rinse the product with deionized water adequately and completely dry it so that no cleaner is left.

\* For other cleaning, please consult our technical department.

Please contact us.

**10-8. Operating Environment**

Do not use this product under the following environmental conditions, on deterioration of the Insulation Resistance of the Ferrite material and/or corrosion of Inner Electrode may result from the use.

- (1) in the corrodible atmosphere such as acidic gases, alkaline gases, chlorine, sulfur gases, organic gases and etc.  
(the sea breeze, Cl<sub>2</sub>, H<sub>2</sub>S, NH<sub>3</sub>, SO<sub>2</sub>, NO<sub>2</sub>, etc)
- (2) in the atmosphere where liquid such as organic solvent, may splash on the products.
- (3) in the atmosphere where the temperature / humidity changes rapidly and it is easy to dew.

**10-9. Resin coating**

When products are coated with resin, please contact us in advance.

**10-10. Handling of a substrate**

After mounting products on a substrate, do not apply any stress to the product caused by bending or twisting to the substrate when cropping the substrate, inserting and removing a connector from the substrate or tightening screw to the substrate.

Excessive mechanical stress may cause cracking in the product.

Bending

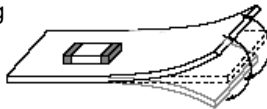

Twisting

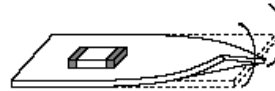
**10-11. Storage Conditions****(1) Storage period**

Use the products within 6 months after delivered.

Solderability should be checked if this period is exceeded.

**(2) Storage conditions**

- Products should be stored in the warehouse on the following conditions.

Temperature : -10°C to 40°C

Humidity : 15% to 85% relative humidity

No rapid change on temperature and humidity

- Don't keep products in corrosive gases such as sulfur, chlorine gas or acid, or it may cause oxidation of electrode, resulting in poor solderability.
- Products should be stored on the palette for the prevention of the influence from humidity, dust and so on.
- Products should be stored in the warehouse without heat shock, vibration, direct sunlight and so on.
- Avoid storing the product by itself bare (i.e. exposed directly to air).

**(3) Delivery**

Care should be taken when transporting or handling product to avoid excessive vibration or mechanical shock.

**11.  Note**

- (1) Please make sure that your product has been evaluated in view of your specifications with our product being mounted to your product.
- (2) You are requested not to use our product deviating from the reference specifications.
- (3) The contents of this reference specification are subject to change without advance notice. Please approve our product specifications or transact the approval sheet for product specifications before ordering.