

BF2 FUSE RATED 58V



Specifications

Housing:	Out of thermoplastic (UL 94-V0, heat-resistant) Visible melting element
Terminal:	Copper alloy, gal. Sn 2 x M8 bolts, Distance 51 mm
Mounting Torque:	12.0 Nm +/- 1Nm
Breaking Capacity:	1000A, 58V DC
Complies with:	ISO 8820-5 UL 248 Special Purpose Fuses

Ordering Information

Part Number	Package Size
142.5395.xxx2	200









Description

This BF2 fuse is rated at 58V and offers a bolt-on fuse for high current wiring protection. Current rating 100A - 300A; with transparent housing for easy detection of blown fuses.

Time-Current Characteristics

% of Rating	Opening Time Min / Max (s)	
	100A - 250A	300A
75	- / -	- / -
100	4 h / -	4 h / -
135	120 s / 1,800 s	- / -
200	1 s / 15 s	1 s / 15 s
350	0.300 s / 5 s	0.500 s / 5 s
600	0.100 s / 1 s	0.100 s / 1 s

Ratings

Part Number	Current Rating	Housing Color	Typ. Voltage Drop	Cold Resistance	I ² t
142.5395.6102	100 A		110 mV	0.70 mΩ	46,800 A ² s
142.5395.6122	125 A		110 mV	0.52 mΩ	118,100 A ² s
142.5395.6152	150 A		110 mV	0.42 mΩ	113,400 A ² s
142.5395.6172	175 A		110 mV	0.36 mΩ	154,400 A ² s
142.5395.6202	200 A		110 mV	0.34 mΩ	288,000 A ² s
142.5395.6222	225 A		110 mV	0.29 mΩ	236,000 A ² s
142.5395.6252	250 A		110 mV	0.25 mΩ	292,500 A ² s
142.5395.6302 ¹	300 A		110 mV	0.21 mΩ	486,000 A ² s

Note 1: Short circuit protectors only.

BF2 FUSE RATED 58V



Dimensions

Dimensions in mm

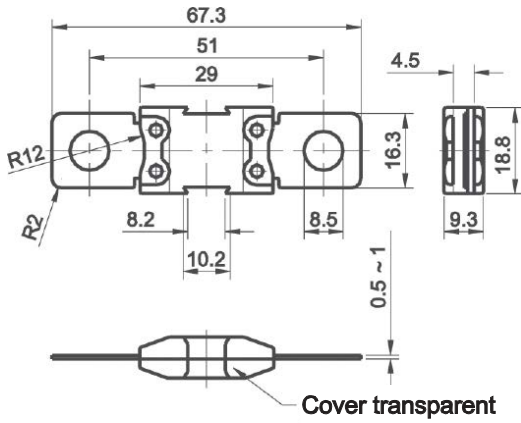

Pre-Arcing Time-Limits

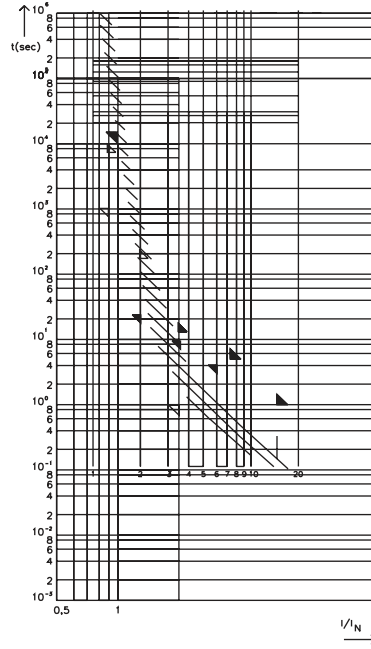

FI = 1.25 (max. operating current: $0.8 \times I_{rat}$ at 23°C)