

ANGELINA-W-B

~50° wide beam compatible with BJB and B+W connectors

SPECIFICATION:

| | |
|----------------|-----------|
| Dimensions | Ø 82.0 mm |
| Height | 31 mm |
| Fastening | socket |
| ROHS compliant | yes ⓘ |



MATERIALS:

| Component | Type | Material | Colour | Finish | Coating |
|--------------|-----------|----------|--------|--------|---------|
| ANGELINA-W-B | Reflector | PC | metal | | HMDS |

ORDERING INFORMATION:

| Component | Qty in box | MOQ | MPQ | Box weight (kg) |
|--|------------|-----|-----|-----------------|
| F13661_ANGLELINA-W-B » Box size: 480 x 280 x 300 mm | 825 | 110 | 55 | 10.6 |

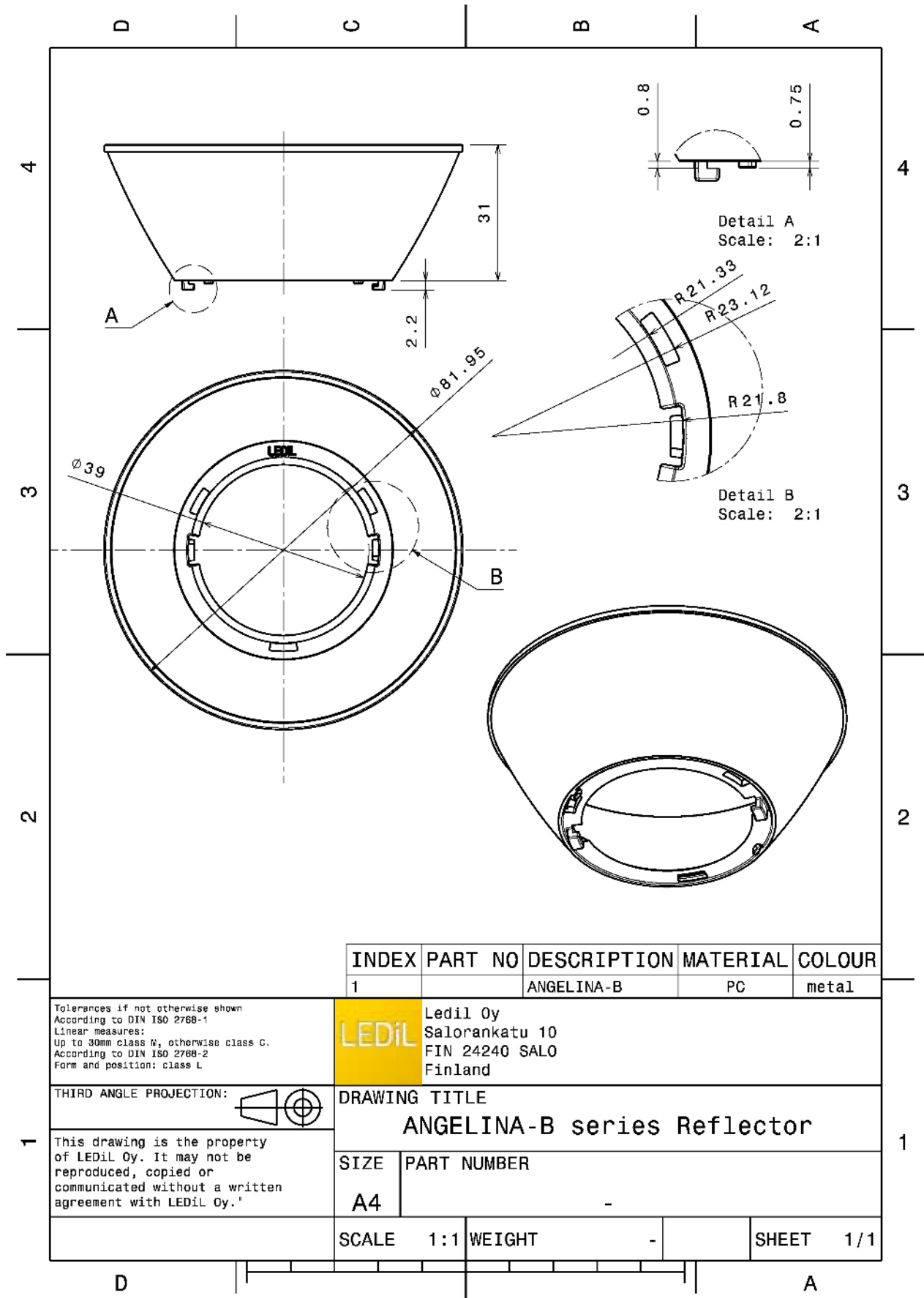

| INDEX | PART NO | DESCRIPTION | MATERIAL | COLOUR |
|-------|---------|-------------|----------|--------|
| 1 | | ANGELINA-B | PC | metal |

Tolerances if not otherwise shown
 According to DIN ISO 2768-1
 Linear measures:
 Up to 30mm class M, otherwise class C.
 According to DIN ISO 2768-2
 Form and position: class L

LEDiL Ledil Oy
 Salorankatu 10
 FIN 24240 SALO
 Finland

THIRD ANGLE PROJECTION:

DRAWING TITLE
ANGELINA-B series Reflector







This drawing is the property of LEDiL Oy. It may not be reproduced, copied or communicated without a written agreement with LEDiL Oy.

| SIZE | PART NUMBER |
|------|-------------|
| A4 | - |

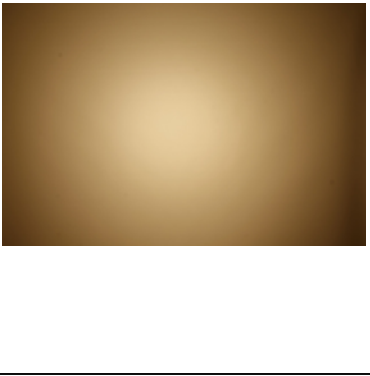
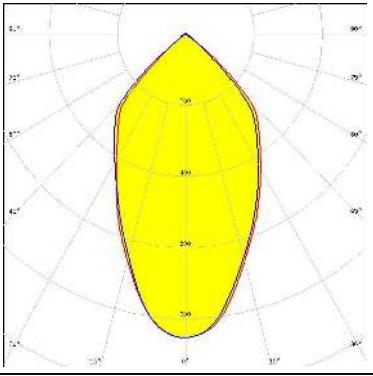
| SCALE | 1:1 | WEIGHT | - | SHEET | 1/1 |
|-------|-----|--------|---|-------|-----|
|-------|-----|--------|---|-------|-----|

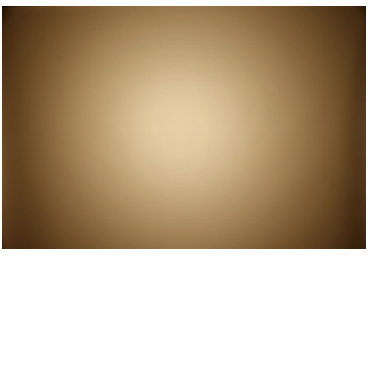
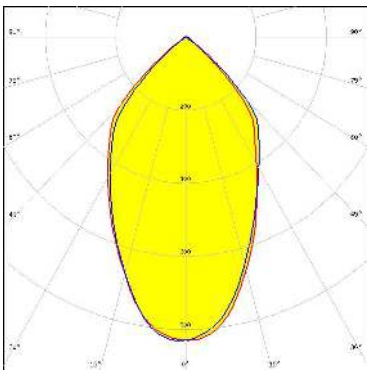
See also our general installation guide: www.ledil.com/installation_guide

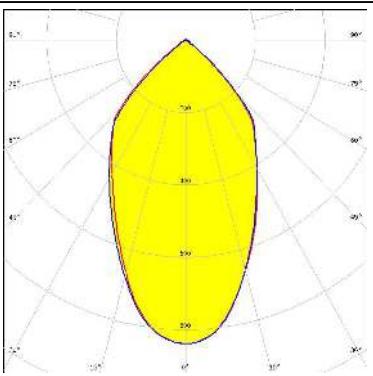
OPTICAL RESULTS (MEASURED):

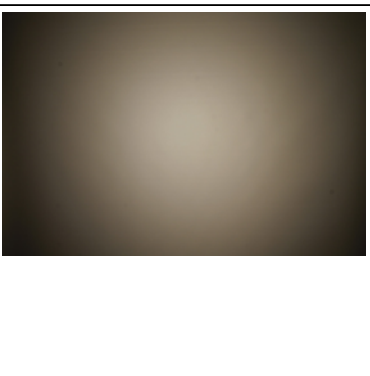
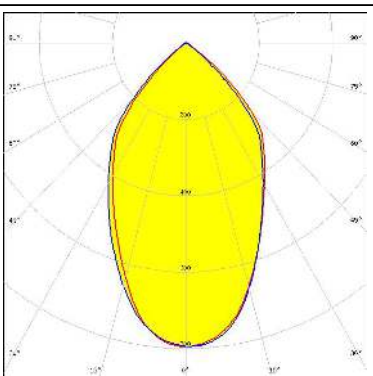
| | | |
|--|--|---|
| <p></p> <p>LED V15 Gen6 FWHM / FWTM 59.0° / 101.0° Efficiency 92 % Peak intensity 0.9 cd/lm LEDs/each optic 1 Light colour White Required components: BJB: 47.319.2224</p> |  |  |
| <p></p> <p>LED V18 Gen6 FWHM / FWTM 61.0° / 101.0° Efficiency 92 % Peak intensity 0.8 cd/lm LEDs/each optic 1 Light colour White Required components: BJB: 47.319.2274</p> |  |  |
| <p></p> <p>LED V18 Gen7 FWHM / FWTM 60.0° / 102.0° Efficiency 93 % Peak intensity 0.8 cd/lm LEDs/each optic 1 Light colour White Required components: BJB: 47.319.2350</p> |  |  |
| <p></p> <p>LED V22 Gen6 FWHM / FWTM 63.0° / 101.0° Efficiency 90 % Peak intensity 0.8 cd/lm LEDs/each optic 1 Light colour White Required components: A.A.G. STUCCHI: 8102-G2</p> |  |  |

OPTICAL RESULTS (MEASURED):

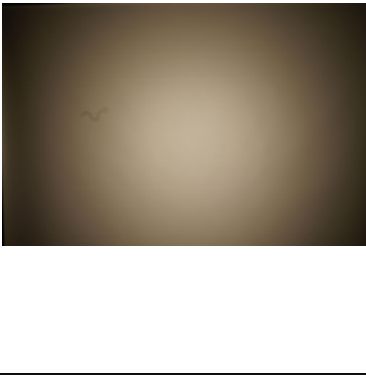
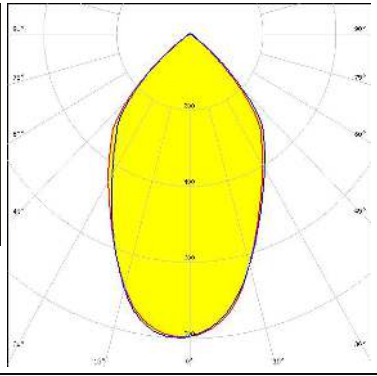
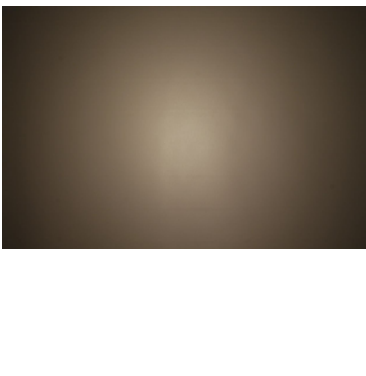
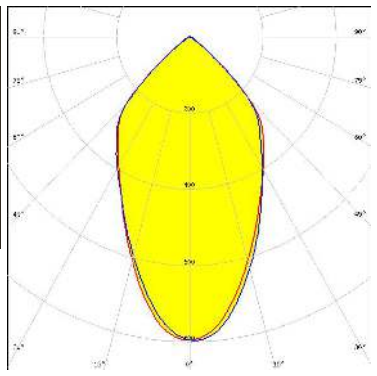
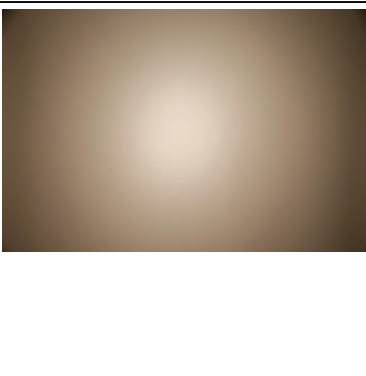
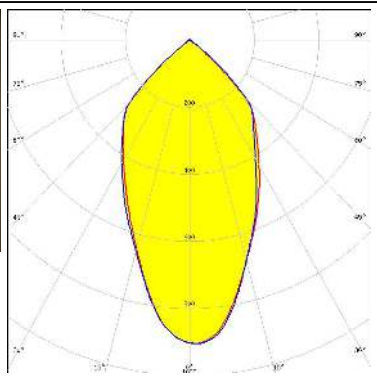
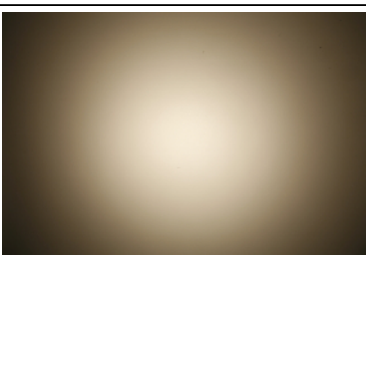
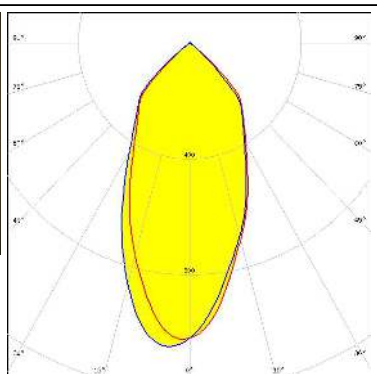
| | | |
|--|--|---|
| <p></p> <p>LED V22 Gen7 FWHM / FWTM 63.0° / 102.0° Efficiency 90 % Peak intensity 0.8 cd/m LEDs/each optic 1 Light colour White Required components: BJB: 47.319.2030</p> |  |  |
| <p>CITIZEN</p> <p>LED CLL03x/CLU03x FWHM / FWTM 60.0° / 102.0° Efficiency 89 % Peak intensity 0.8 cd/m LEDs/each optic 1 Light colour White Required components: F13671_ANGE-RZ-LENS A.A.G. STUCCHI: 8101-G2</p> |  |  |
| <p>CITIZEN</p> <p>LED CLL03x/CLU03x FWHM / FWTM 55.0° / 100.0° Efficiency 94 % Peak intensity 0.9 cd/m LEDs/each optic 1 Light colour White Required components: A.A.G. STUCCHI: 8101-G2</p> |  |  |
| <p>CITIZEN</p> <p>LED CLL03x/CLU03x FWHM / FWTM 49.0° / 98.0° Efficiency 92 % Peak intensity 1 cd/m LEDs/each optic 1 Light colour White Required components: BJB: 47.319.2021</p> |  |  |

OPTICAL RESULTS (MEASURED):

CITIZEN

LED CLL04x/CLU04x
 FWHM / FWTM 66.0° / 104.0°
 Efficiency 87 %
 Peak intensity 0.7 cd/lm
 LEDs/each optic 1
 Light colour White
 Required components:
 F13671_ANGE-RZ-LENS
 A.A.G. STUCCHI: 8102-G2

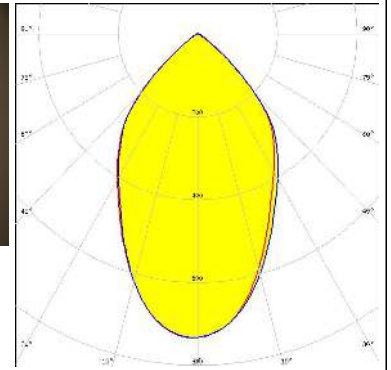
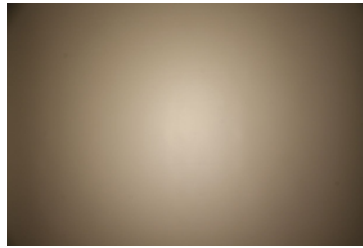

CITIZEN

LED CLL04x/CLU04x
 FWHM / FWTM 62.0° / 102.0°
 Efficiency 92 %
 Peak intensity 0.8 cd/lm
 LEDs/each optic 1
 Light colour White
 Required components:
 A.A.G. STUCCHI: 8102-G2

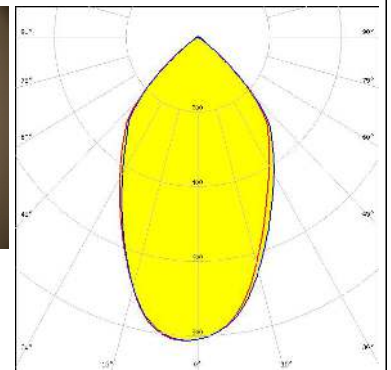
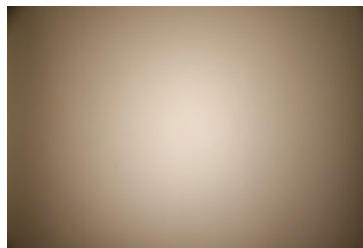

CITIZEN

LED CLU720/721/723
 FWHM / FWTM 51.0° / 100.0°
 Efficiency 94 %
 Peak intensity 1 cd/lm
 LEDs/each optic 1
 Light colour White
 Required components:
 A.A.G. STUCCHI: 8101-G2

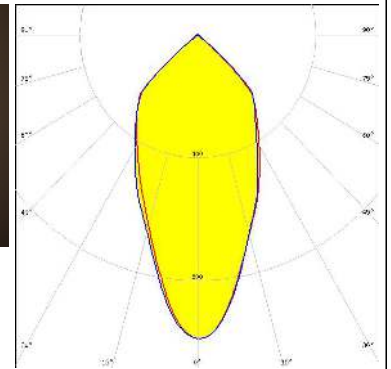
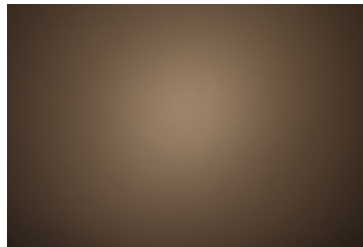

CITIZEN

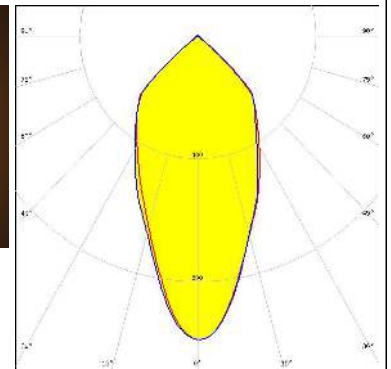
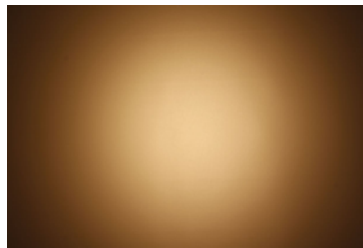

LED CLU720/721/723
 FWHM / FWTM 49.0° / 99.0°
 Efficiency 93 %
 Peak intensity 1 cd/lm
 LEDs/each optic 1
 Light colour White
 Required components:
 BJB: 47.319.2021



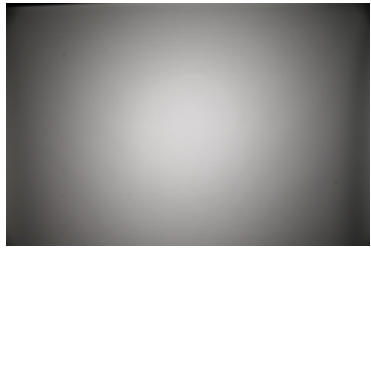
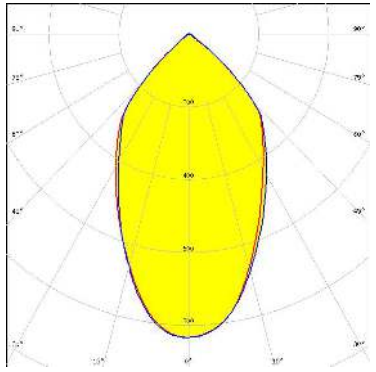
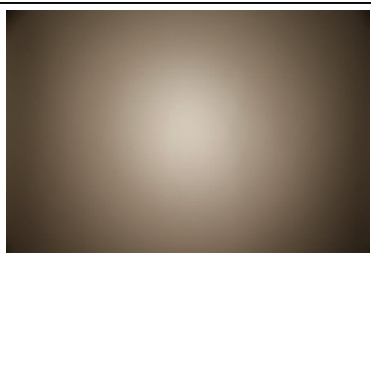
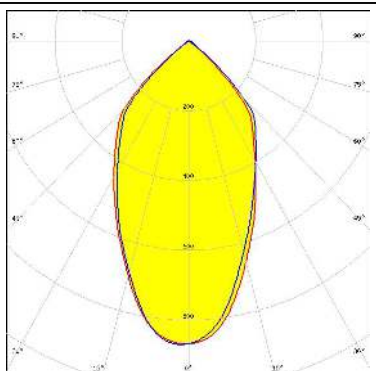
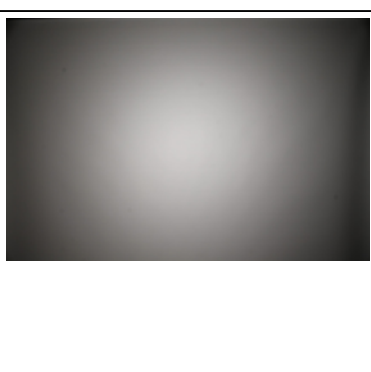
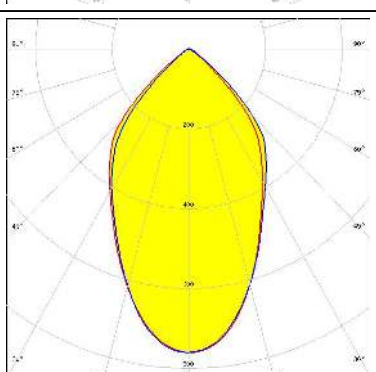
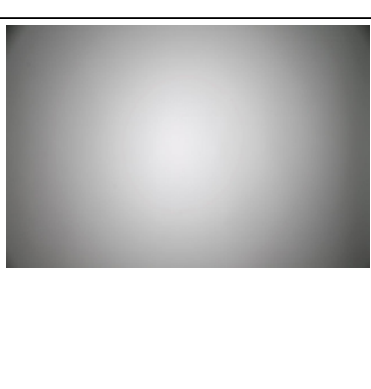
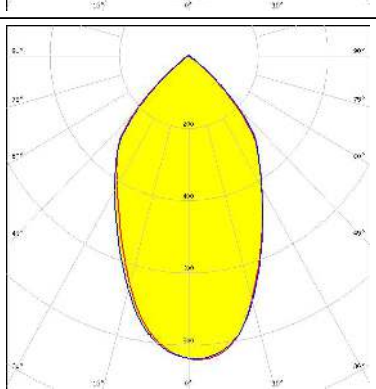

OPTICAL RESULTS (MEASURED):

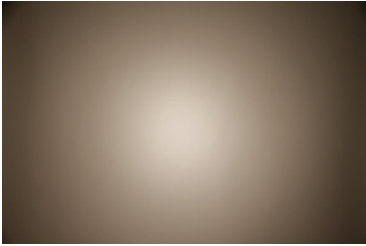
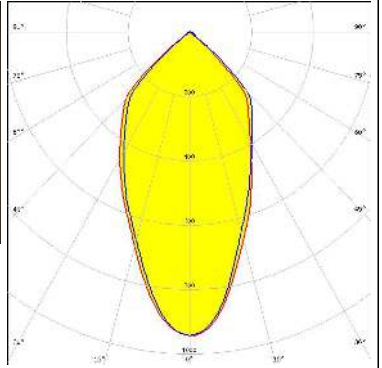
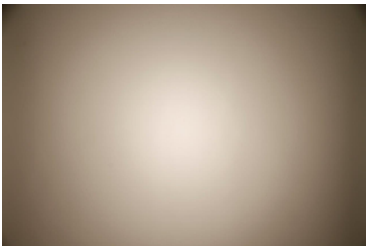
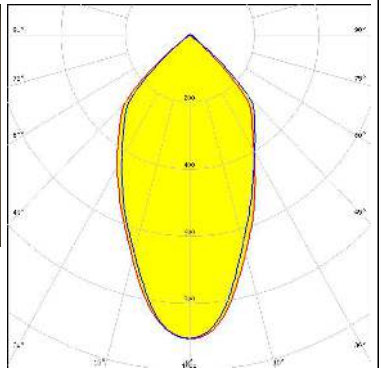
| | | |
|---|--|---|
| <p>CREE ⇄ LED</p> <p>LED CXA/B 25xx FWHM / FWTM 61.0° / 101.0° Efficiency 92 % Peak intensity 0.8 cd/m LEDs/each optic 1 Light colour White Required components: BJB: 47.319.2141</p> |  |  |
| <p>CREE ⇄ LED</p> <p>LED CXA/B 25xx FWHM / FWTM 57.0° / 101.0° Efficiency 93 % Peak intensity 0.9 cd/m LEDs/each optic 1 Light colour White Required components: A.A.G. STUCCHI: 8401-G2</p> |  |  |
| <p>CREE ⇄ LED</p> <p>LED CXA/B 25xx FWHM / FWTM 64.0° / 103.0° Efficiency 88 % Peak intensity 0.8 cd/m LEDs/each optic 1 Light colour White Required components: F13671_ANGE-RZ-LENS BJB: 47.319.2141</p> |  |  |
| <p>CREE ⇄ LED</p> <p>LED CXA/B 30xx FWHM / FWTM 63.0° / 101.0° Efficiency 91 % Peak intensity 0.8 cd/m LEDs/each optic 1 Light colour White Required components: A.A.G. STUCCHI: 8404-G2</p> |  |  |

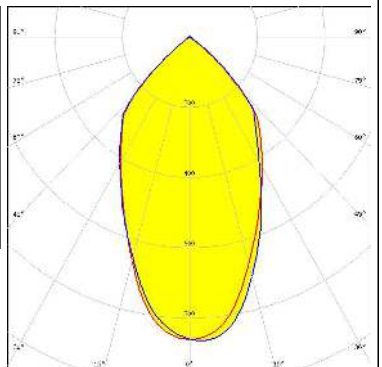
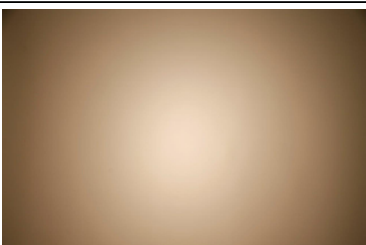
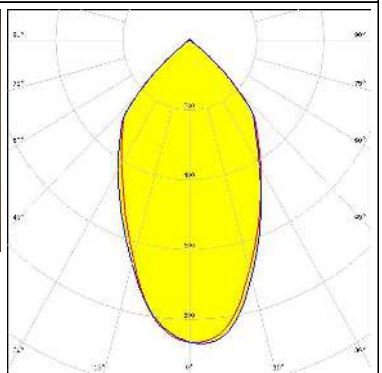
OPTICAL RESULTS (MEASURED):

| | | |
|---|--|---|
| <p>LUMILEDS</p> <p>LED LUXEON CoB 1204/1205</p> <p>FWHM / FWTM 53.0° / 100.0°</p> <p>Efficiency 94 %</p> <p>Peak intensity 0.9 cd/m</p> <p>LEDs/each optic 1</p> <p>Light colour White</p> <p>Required components: A.A.G. STUCCHI: 8301-G2</p> |  |  |
| <p>LUMILEDS</p> <p>LED LUXEON CoB 1208</p> <p>FWHM / FWTM 55.0° / 100.0°</p> <p>Efficiency 93 %</p> <p>Peak intensity 0.9 cd/m</p> <p>LEDs/each optic 1</p> <p>Light colour White</p> <p>Required components: A.A.G. STUCCHI: 8301-G2</p> |  |  |
| <p>LUMILEDS</p> <p>LED LUXEON CoB 1211</p> <p>FWHM / FWTM 58.0° / 101.0°</p> <p>Efficiency 92 %</p> <p>Peak intensity 0.9 cd/m</p> <p>LEDs/each optic 1</p> <p>Light colour White</p> <p>Required components: BJB: 47.319.2030</p> |  |  |
| <p>LUMILEDS</p> <p>LED LUXEON CoB 1211</p> <p>FWHM / FWTM 58.0° / 100.0°</p> <p>Efficiency 92 %</p> <p>Peak intensity 0.9 cd/m</p> <p>LEDs/each optic 1</p> <p>Light colour White</p> <p>Required components: A.A.G. STUCCHI: 8102-G2</p> |  |  |

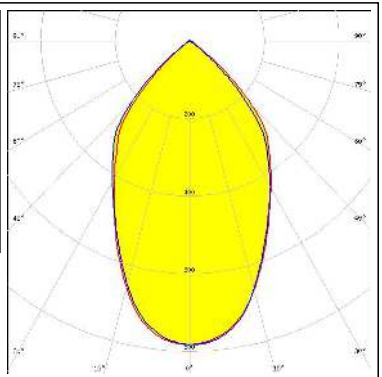

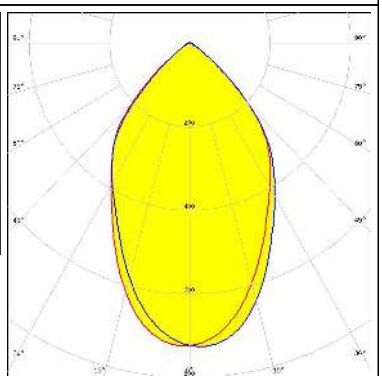
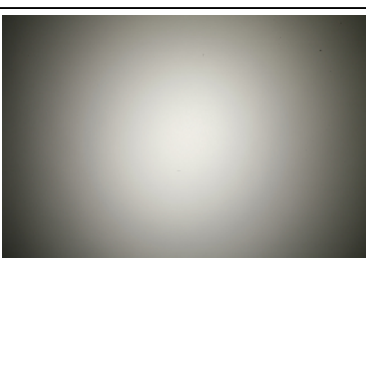
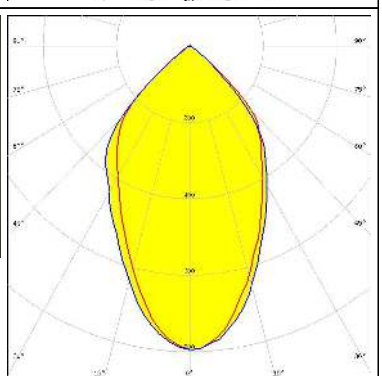
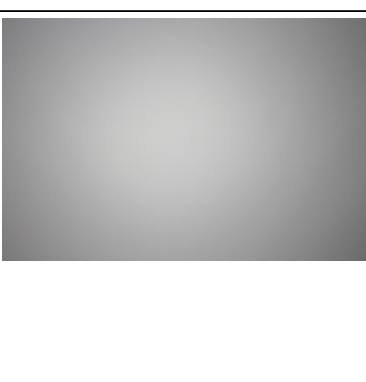
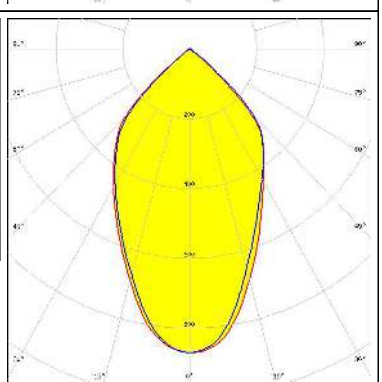
OPTICAL RESULTS (MEASURED):

| | | |
|--|--|---|
| <p>LUMILEDS</p> <p>LED LUXEON CoB 1216/1812</p> <p>FWHM / FWTM 65.0° / 102.0°</p> <p>Efficiency 91 %</p> <p>Peak intensity 0.8 cd/m</p> <p>LEDs/each optic 1</p> <p>Light colour White</p> <p>Required components: BJB: 47.319.2030</p> |  |  |
| <p>LUMILEDS</p> <p>LED LUXEON CoB 1216/1812</p> <p>FWHM / FWTM 67.0° / 104.0°</p> <p>Efficiency 87 %</p> <p>Peak intensity 0.7 cd/m</p> <p>LEDs/each optic 1</p> <p>Light colour White</p> <p>Required components: F13671_ANGE-RZ-LENS BJB: 47.319.2030</p> |  |  |
| <p>LUMILEDS</p> <p>LED LUXEON K12</p> <p>FWHM / FWTM 64.0° / 104.0°</p> <p>Efficiency 89 %</p> <p>Peak intensity 0.8 cd/m</p> <p>LEDs/each optic 1</p> <p>Light colour White</p> <p>Required components: F13671_ANGE-RZ-LENS BJB: 47.319.2070</p> |  |  |
| <p>LUMILEDS</p> <p>LED LUXEON K16</p> <p>FWHM / FWTM 61.0°</p> <p>Efficiency %</p> <p>Peak intensity 0.9 cd/m</p> <p>LEDs/each optic 1</p> <p>Light colour White</p> <p>Required components: BJB: 47.319.2070</p> |  |  |

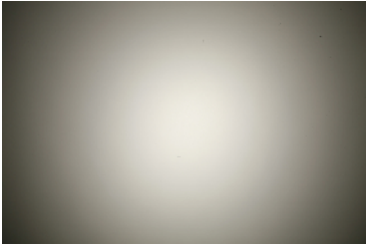
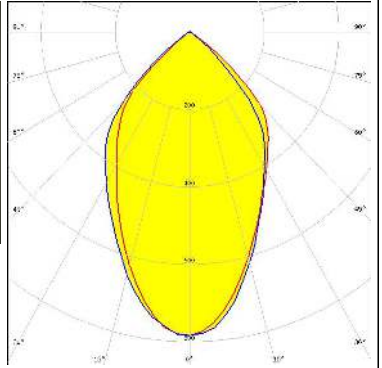
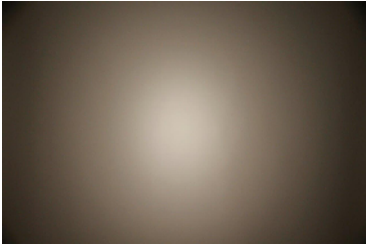
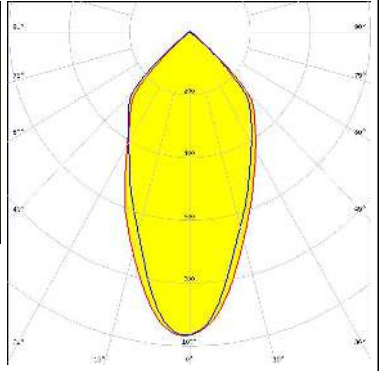
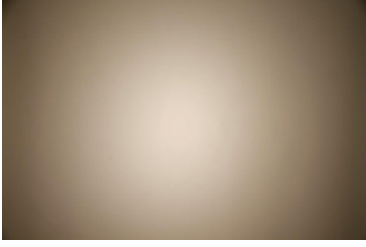
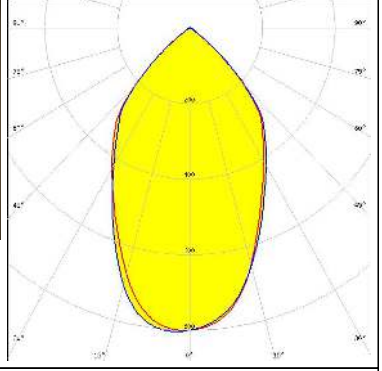
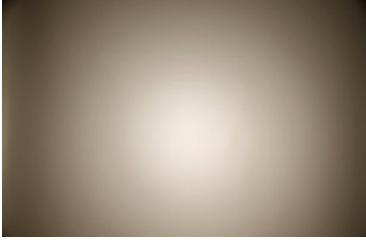
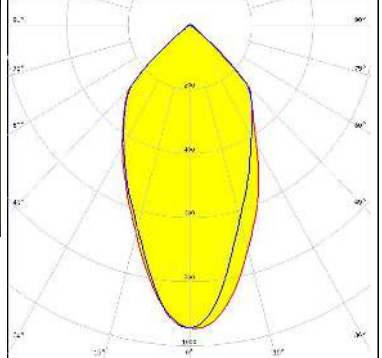
OPTICAL RESULTS (MEASURED):

| | | |
|---|--|---|
| <p>LUMILEDS</p> <p>LED LUXEON K16 FWHM / FWTM 65.0° / 104.0° Efficiency 89 % Peak intensity 0.8 cd/lm LEDs/each optic 1 Light colour White Required components: F13671_ANGE-RZ-LENS BJB: 47.319.2070</p> |  |  |
| <p>LUMINUS</p> <p>LED CxM-14 (19x19) FWHM / FWTM 51.0° / 99.0° Efficiency 93 % Peak intensity 1 cd/lm LEDs/each optic 1 Light colour White Required components: BJB: 47.319.2021</p> |  |  |
| <p>LUMINUS</p> <p>LED CxM-22 (28x28) FWHM / FWTM 63.0° / 102.0° Efficiency 92 % Peak intensity 0.8 cd/lm LEDs/each optic 1 Light colour White Required components: BJB: 47.319.2030</p> |  |  |
| <p>OSRAM <small>Opto Semiconductors</small></p> <p>LED Soleriq S13 FWHM / FWTM 52.0° / 100.0° Efficiency 94 % Peak intensity 1 cd/lm LEDs/each optic 1 Light colour White Required components: A.A.G. STUCCHI: 8502-G2</p> |  |  |

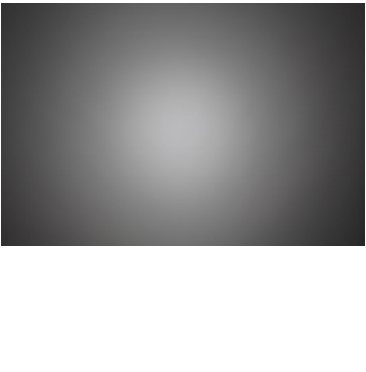
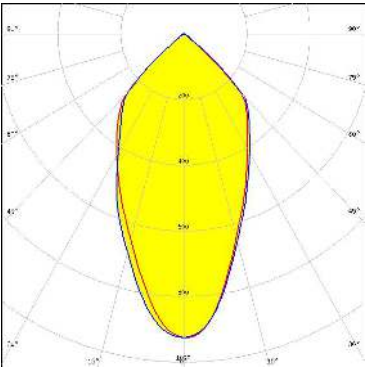
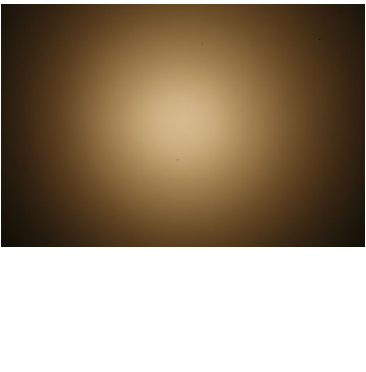
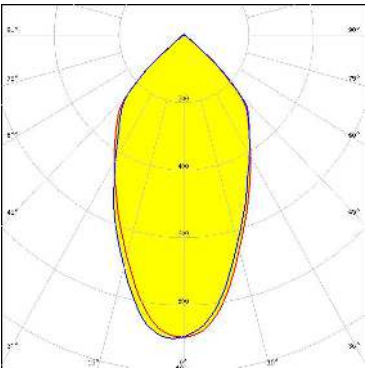
OPTICAL RESULTS (MEASURED):

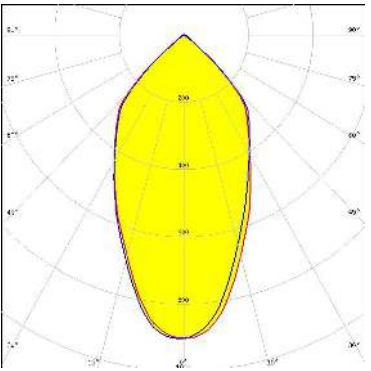
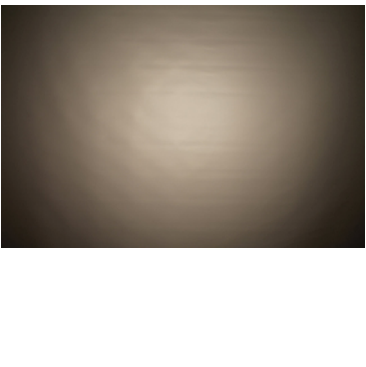
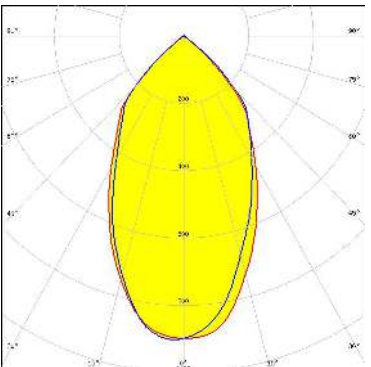
| | | |
|---|--|---|
| <p>OSRAM Opto Semiconductors</p> <p>LED Soleriq S13 19x19</p> <p>FWHM / FWTM 53.0° / 100.0°</p> <p>Efficiency 93 %</p> <p>Peak intensity 0.9 cd/m</p> <p>LEDs/each optic 1</p> <p>Light colour White</p> <p>Required components: BJB: 47.319.2021</p> |  |  |
| <p>OSRAM Opto Semiconductors</p> <p>LED Soleriq S19</p> <p>FWHM / FWTM 55.0° / 100.0°</p> <p>Efficiency 93 %</p> <p>Peak intensity 0.9 cd/m</p> <p>LEDs/each optic 1</p> <p>Light colour White</p> <p>Required components: BJB: 47.319.2170</p> |  |  |
| <p>OSRAM Opto Semiconductors</p> <p>LED Soleriq S19</p> <p>FWHM / FWTM 55.0° / 100.0°</p> <p>Efficiency 93 %</p> <p>Peak intensity 0.9 cd/m</p> <p>LEDs/each optic 1</p> <p>Light colour White</p> <p>Required components: A.A.G. STUCCHI: 8503-G2</p> |  |  |
| <p>PHILIPS</p> <p>LED Fortimo SLM L19 CoB</p> <p>FWHM / FWTM 58.0° / 100.0°</p> <p>Efficiency 93 %</p> <p>Peak intensity 0.9 cd/m</p> <p>LEDs/each optic 1</p> <p>Light colour White</p> <p>Required components: BJB: 47.319.2030</p> |  |  |

OPTICAL RESULTS (MEASURED):

PHILIPS

LED Fortimo SLM L19 CoB
 FWHM / FWTM 60.0° / 102.0°
 Efficiency 88 %
 Peak intensity 0.8 cd/lm
 LEDs/each optic 1
 Light colour White
 Required components:
 F13671_ANGE-RZ-LENS
 BJB: 47.319.2030

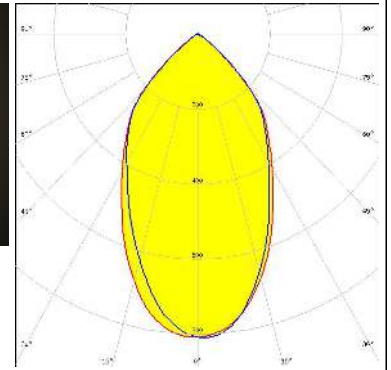
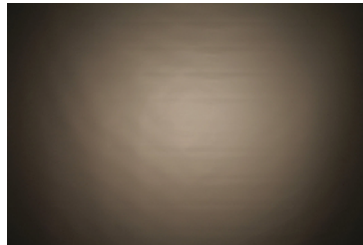

PHILIPS

LED Fortimo SLM L23 CoB
 FWHM / FWTM 62.0° / 102.0°
 Efficiency 88 %
 Peak intensity 0.8 cd/lm
 LEDs/each optic 1
 Light colour White
 Required components:
 F13671_ANGE-RZ-LENS
 BJB: 47.319.2030

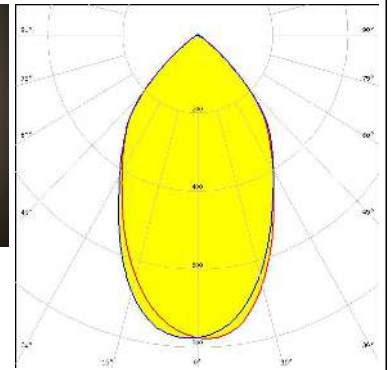
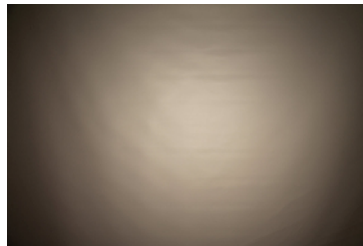

PHILIPS

LED Fortimo SLM L23 CoB
 FWHM / FWTM 60.0° / 101.0°
 Efficiency 93 %
 Peak intensity 0.9 cd/lm
 LEDs/each optic 1
 Light colour White
 Required components:
 BJB: 47.319.2030

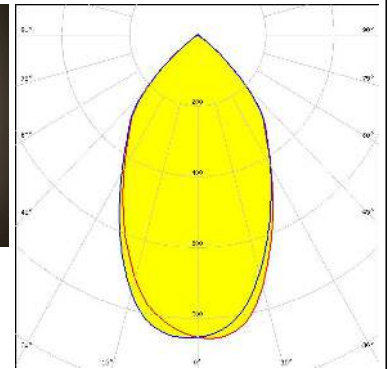
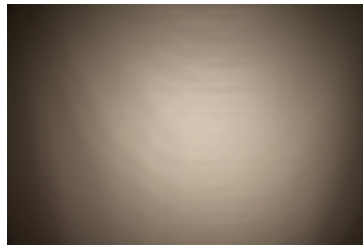

SAMSUNG

LED LC016D / LC019D / LC026D / LC033D
 FWHM / FWTM 62.0° / 103.0°
 Efficiency 89 %
 Peak intensity 0.8 cd/lm
 LEDs/each optic 1
 Light colour White
 Required components:
 F13671_ANGE-RZ-LENS
 A.A.G. STUCCHI: 8101-G2

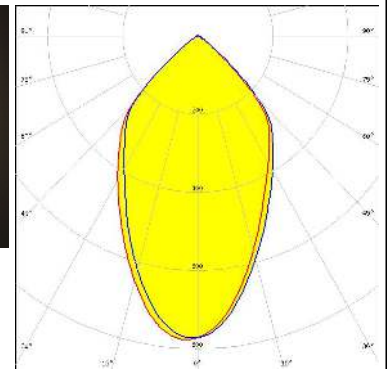
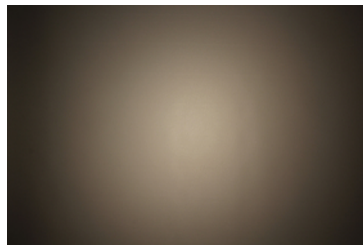

OPTICAL RESULTS (MEASURED):

SAMSUNG

LED LC016D / LC019D / LC026D / LC033D
 FWHM / FWTM 59.0° / 101.0°
 Efficiency 93 %
 Peak intensity 0.9 cd/m
 LEDs/each optic 1
 Light colour White
 Required components:
 A.A.G. STUCCHI: 8101-G2

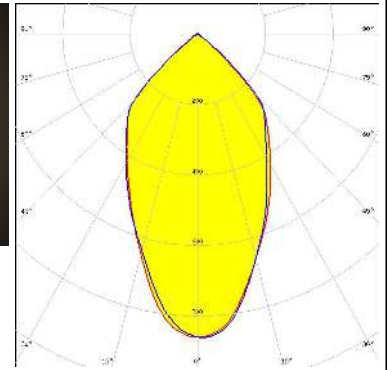
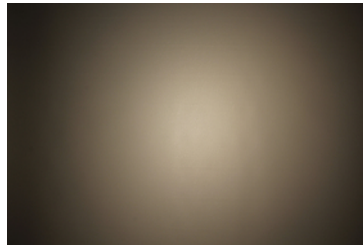

SAMSUNG

LED LC016D / LC019D / LC026D / LC033D
 FWHM / FWTM 62.0° / 103.0°
 Efficiency 89 %
 Peak intensity 0.8 cd/m
 LEDs/each optic 1
 Light colour White
 Required components:
 F13671_ANGE-RZ-LENS
 BJB: 47.319.2021

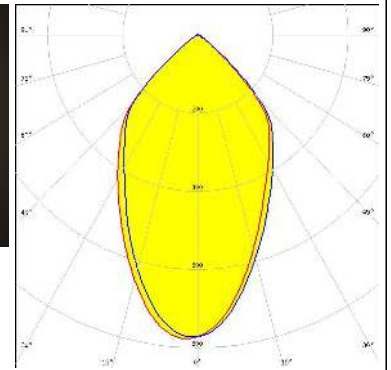
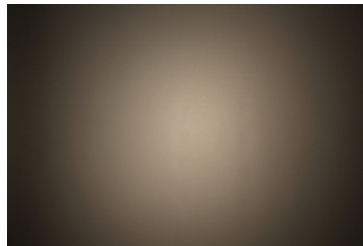

SAMSUNG

LED LC016D / LC019D / LC026D / LC033D
 FWHM / FWTM 59.0° / 101.0°
 Efficiency 93 %
 Peak intensity 0.9 cd/m
 LEDs/each optic 1
 Light colour White
 Required components:
 BJB: 47.319.2021

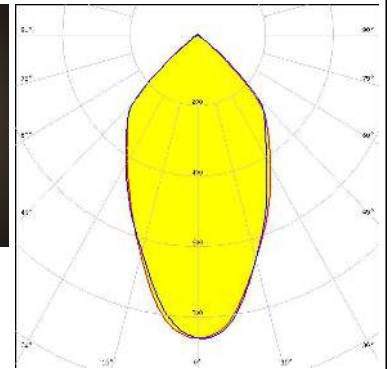
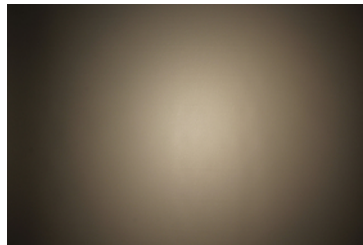

SEUL SEMICONDUCTOR
 LED ZC12/18
 FWHM / FWTM 54.0° / 99.0°
 Efficiency 93 %
 Peak intensity 0.9 cd/m
 LEDs/each optic 1
 Light colour White
 Required components:
 A.A.G. STUCCHI: 8101-G2

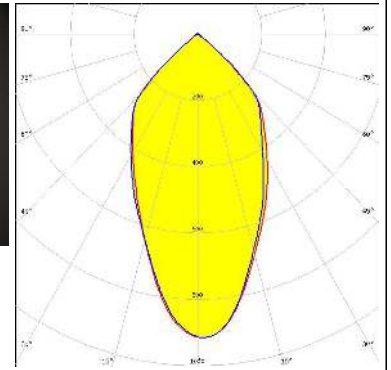
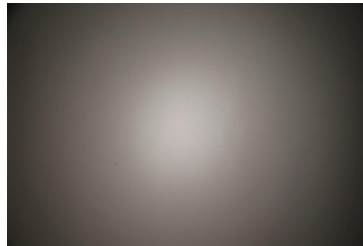

OPTICAL RESULTS (MEASURED):

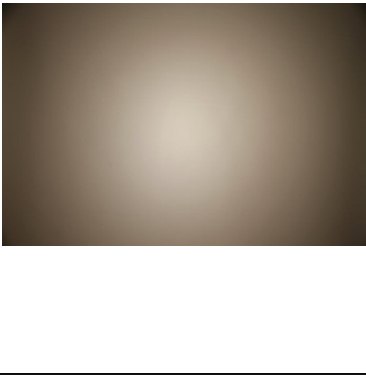
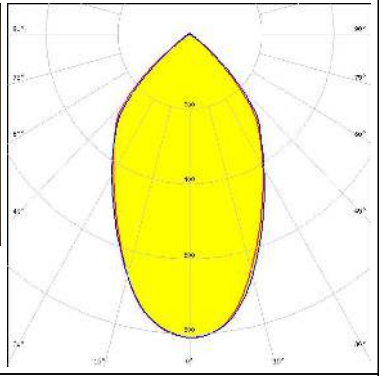
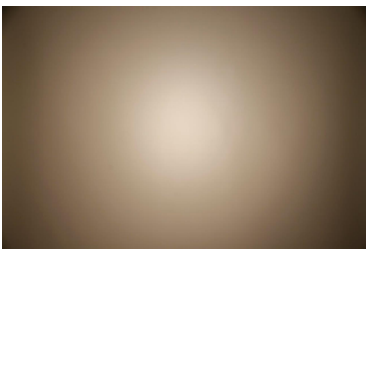
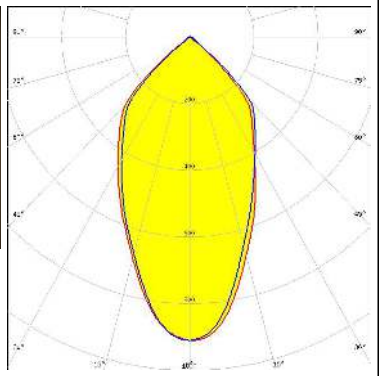
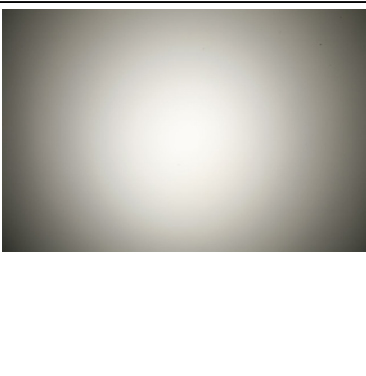
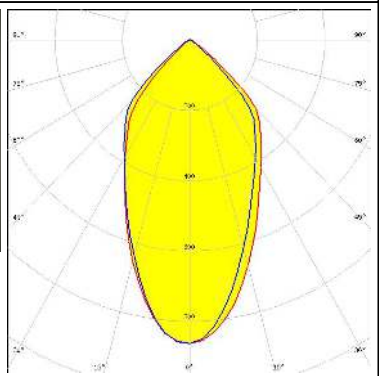
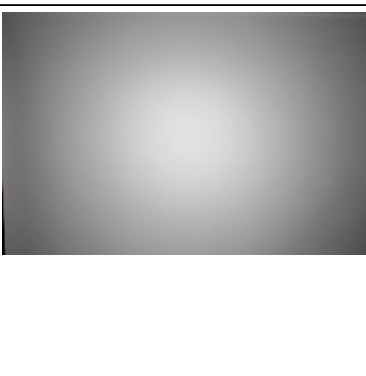
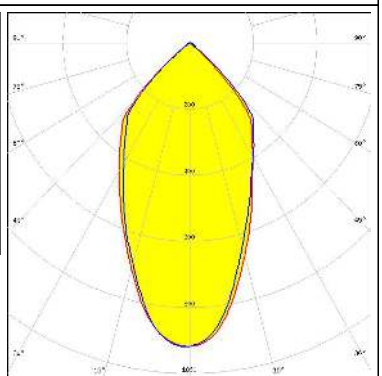
| | | |
|---|--|---|
| <p> SEOL SEMICONDUCTOR</p> <p>LED ZC25/40/60</p> <p>FWHM / FWTM 62.0° / 102.0°</p> <p>Efficiency 92 %</p> <p>Peak intensity 0.8 cd/m</p> <p>LEDs/each optic 1</p> <p>Light colour White</p> <p>Required components: A.A.G. STUCCHI: 8102-G2</p> |  |  |
| <p>SHARP</p> <p>LED Mega Zenigata (GW6DME)</p> <p>FWHM / FWTM 55.0° / 100.0°</p> <p>Efficiency 94 %</p> <p>Peak intensity 0.9 cd/m</p> <p>LEDs/each optic 1</p> <p>Light colour White</p> <p>Required components: A.A.G. STUCCHI: 8301-G2</p> |  |  |
| <p>SHARP</p> <p>LED Tiger Zenigata (GWTGCBG4FD)</p> <p>FWHM / FWTM 54.0° / 101.0°</p> <p>Efficiency 90 %</p> <p>Peak intensity 0.9 cd/m</p> <p>LEDs/each optic 1</p> <p>Light colour White</p> <p>Required components: F13671_ANGE-RZ-LENS BJB: 47.319.2051</p> |  |  |
| <p>TRIDONIC</p> <p>LED SLE G7 LES17 H</p> <p>FWHM / FWTM 53.0° / 99.0°</p> <p>Efficiency 91 %</p> <p>Peak intensity 0.9 cd/m</p> <p>LEDs/each optic 1</p> <p>Light colour White</p> <p>Required components:</p> |  |  |

OPTICAL RESULTS (MEASURED):

TRIDONIC

LED SLE G7 LES21 H
 FWHM / FWTM 59.0° / 100.0°
 Efficiency 91 %
 Peak intensity 0.9 cd/lm
 LEDs/each optic 1
 Light colour White
 Required components:

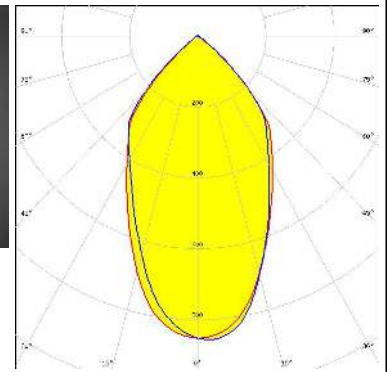
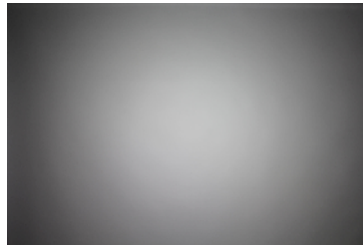

XICATO

LED XOB 14.5 mm
 FWHM / FWTM 57.0° / 100.0°
 Efficiency 94 %
 Peak intensity 0.9 cd/lm
 LEDs/each optic 1
 Light colour White
 Required components:
 BJB: 47.319.2021

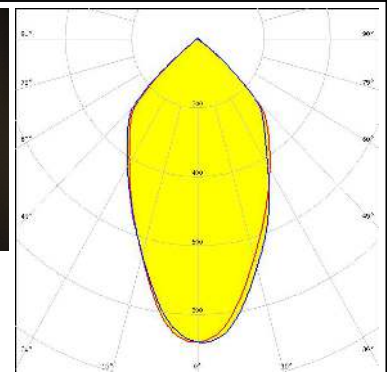
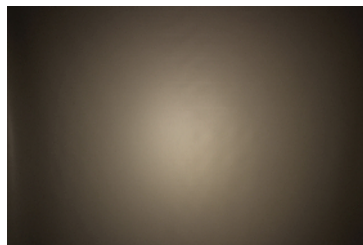

XICATO

LED XTM - 19mm LES
 FWHM / FWTM 59.0° / 101.0°
 Efficiency 92 %
 Peak intensity 0.9 cd/lm
 LEDs/each optic 1
 Light colour White
 Required components:
 C15743_XTM-ADAPTER-50-B

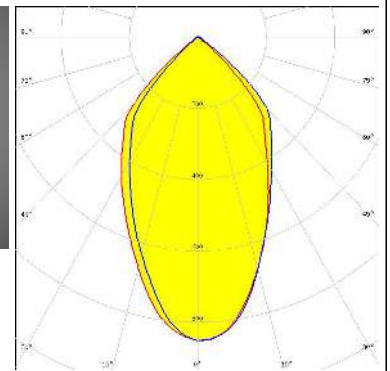

OPTICAL RESULTS (SIMULATED):

CITIZEN

LED CLL04x/CLU04x
 FWHM / FWTM 52.0° / 94.0°
 Efficiency 95 %
 Peak intensity 1.1 cd/lm
 LEDs/each optic 1
 Light colour White
 Required components:
 BJB: 47.319.2030

CITIZEN

LED CLL04x/CLU04x
 FWHM / FWTM 55.0° / 98.0°
 Efficiency 90 %
 Peak intensity 0.9 cd/lm
 LEDs/each optic 1
 Light colour White
 Required components:
 BJB: 47.319.2030

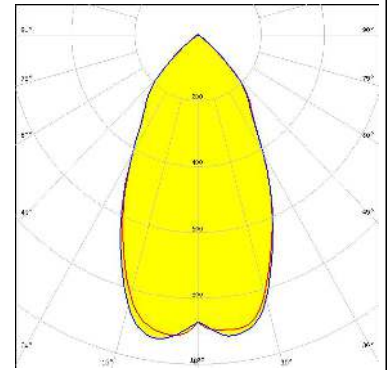

CITIZEN

LED CLU730/731/733
 FWHM / FWTM 52.0° / 98.0°
 Efficiency 93 %
 Peak intensity 1.1 cd/lm
 LEDs/each optic 1
 Light colour White
 Required components:
 BJB: 47.319.2030

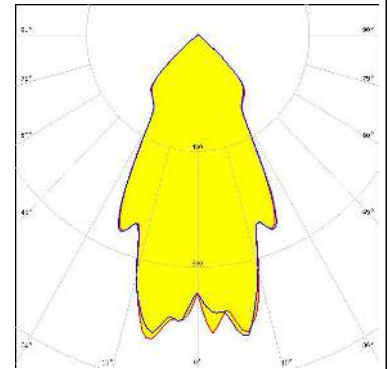

SAMSUNG

LED LC040D / LC060D / LC080D
 FWHM / FWTM 54.0° / 97.0°
 Efficiency 90 %
 Peak intensity 1 cd/lm
 LEDs/each optic 1
 Light colour White
 Required components:
 BJB: 47.319.2030

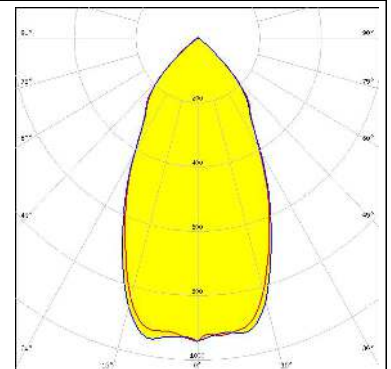

GENERAL INFORMATION:

NOTE: The typical beam angle will be changed by different color, chip size and chip position tolerance. The typical total beam angle is the full angle measured where the luminous intensity is half of the peak value.

Due to use of high power COB's with this product, special attention to proper thermal design is highly recommended. LEDiL has no liability for direct, indirect or consecutive damages arising from the LEDiL products being used outside of the recommended temperature range.

MATERIALS:

As part of our continuous research and improvement processes, and to ensure the best possible quality and availability of our products, LEDiL reserves the right to change material grades without notice.

PRODUCT DATA USER AGREEMENT AND DISCLAIMER:

The measured data in the provided downloadable LEDiL Product Datasheets and Mechanical 2D-Drawings is rounded and provided as reference for planning. LEDiL Oy's optical specifications have been verified by conducting performance testing of the products in accordance with the company's quality system. The reported data are averaged results of multiple measurements with typical variation. LEDiL Oy reserves the right to without prior notification make changes and improvements to its products.

LEDiL Oy assumes neither warranty, nor guarantee nor any other liability of any kind for the contents and correctness of the provided data. The provided data has been generated with highest diligence but the provided data may in reality not represent the complete possible variation range of all intrinsic parameters. Therefore, in certain cases a deviation from the provided data could occur.

LEDiL Oy reserves the right to undertake technical changes of its products without further notification which could lead to changes in the provided data. LEDiL Oy assumes no liability of any kind for the possible deviation from any provided data or any other damage resulting from the usage of the provided data.

The user agrees to this disclaimer and user agreement with the download or usage of the provided files.

LEDiL Oy

Joensuunkatu 13
FI-24240 SALO
Finland

LEDiL Inc.

228 West Page Street
Suite D
Sycamore IL 60178
USA

Ledil Optics Technology (Shenzhen) Co., Ltd.

405 , Block B
Casic Motor Building
Shenzhen 518057
P.R.CHINA

Local sales and technical support

[www.ledil.com/
where_to_buy](http://www.ledil.com/where_to_buy)

Shipping locations

Salo, Finland
Hong Kong, China

Distribution Partners

[www.ledil.com/
where_to_buy](http://www.ledil.com/where_to_buy)