

**TNC ATTENUATOR**  
**7 DB 3 GHZ 1W**

**R412.507.124**  
Series : ATTENUATOR

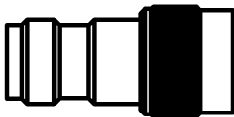
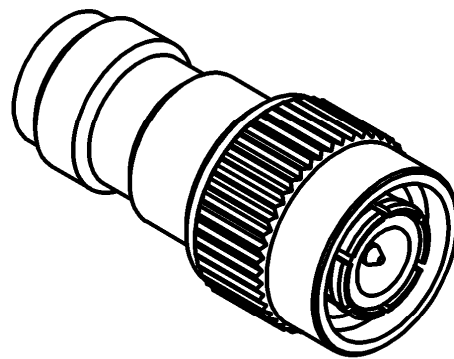
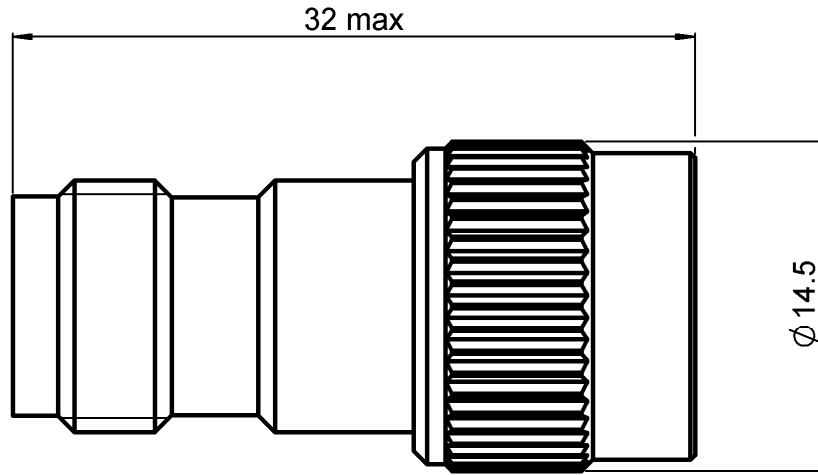

SCALE 1/1

All dimensions are in mm.



COMPONENTS	MATERIALS	PLATING(µm)
BODY	BRASS	NICKEL 2
MALE CENTER CONTACT	BRASS	GOLD 1 OVER NICKEL 2
FEMALE CENTER CONTACT	BERYLLIUM COPPER	GOLD 1 OVER NICKEL 2
OUTER CONTACT		
INSULATOR	PTFE	
GASKET	SILICONE RUBBER	
SUBSTRATE	ALUMINA	
RESISTOR	THICK FILM	
OTHERS PARTS		

Issue : 0827 A

In the effort to improve our products, we reserve the right to make changes judged to be necessary.



**TNC ATTENUATOR**  
**7 DB 3 GHZ 1W**

**R412.507.124**  
 Series : ATTENUATOR

**ELECTRICAL CHARACTERISTICS**

Frequency (GHz)	DC - 2	2 - 3
V.S.W.R (≤)	1.20	1.30
Deviation(±dB)	0.5	0.5

Operating Frequency Range	DC - 3	GHz
Impedance	50	Ω
Nominal Attenuation	7	dB
Peak power at 25°C (1μs, 1%)	100	W
Average power at 25°C	1	W (Free Air Cooled)
		W (Conduction Cooled)

**MECHANICAL CHARACTERISTICS**

Connectors	TNC	Male Female	MIL-C 39012
Weight	16,7660 g		

**ENVIRONMENTAL CHARACTERISTICS**

Operating temperature range	-40 / +85 °C
Storage temperature range	-40 / +85 °C

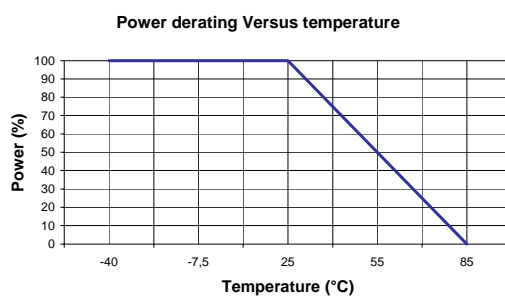

**SPECIFICATION**

**OTHER CHARACTERISTICS**

Issue : 0827 A

In the effort to improve our products, we reserve the right to make changes judged to be necessary.

